

# Operation Manual

41L Series – Rev 1.2 P/N 160905-10

# 41L Series Programmable DC Load



**CALTEST**  
Instruments  
GmbH

**Caltest Instruments GmbH**

Kohl mattstrasse 7 | Tel: +49(0)7842-99722-00  
D-77876 KAPPELRODECK | Fax: +49(0)7842-99722-29  
info@caltest.de | www.caltest.de



™

## ADAPTIVE Power Systems

Worldwide Supplier of Power Equipment

Copyright © 2014, Adaptive Power Systems, Inc. (APS) • All Rights Reserved • No reproduction without written authorization from APS.

-

PAGE LEFT INTENTIONALLY LEFT BLANK FOR HARDCOPY VERSIONS OF THIS DOCUMENT



## Table of Contents

|          |  |           |
|----------|--|-----------|
| <b>1</b> | <b>Contact Information .....</b>                       | <b>8</b>  |
| <b>2</b> | <b>Front Matter .....</b>                              | <b>9</b>  |
| 2.1      | Limited Warranty .....                                 | 9         |
| 2.2      | Service and Spare Parts Limited Warranty .....         | 9         |
| 2.3      | Safety Information.....                                | 9         |
| 2.4      | Safety Notices .....                                   | 11        |
| <b>3</b> | <b>Product Overview .....</b>                          | <b>13</b> |
| 3.1      | General Description.....                               | 13        |
| 3.2      | Operating Modes .....                                  | 13        |
| 3.2.1    | Constant Current Mode .....                            | 14        |
| 3.2.2    | Constant Resistance Mode .....                         | 14        |
| 3.2.3    | Constant Voltage Mode .....                            | 14        |
| 3.2.4    | Constant Power Mode .....                              | 15        |
| 3.3      | Static versus Dynamic Operating Modes .....            | 15        |
| 3.3.1    | Programmable Parameters.....                           | 16        |
| 3.3.2    | Slew Rates .....                                       | 16        |
| 3.3.3    | Determining Actual Transition Times .....              | 17        |
| 3.4      | Current Read-back.....                                 | 19        |
| 3.5      | Analog Input Mode .....                                | 19        |
| 3.6      | Product Features .....                                 | 20        |
| 3.7      | Accessories Included .....                             | 21        |
| 3.7.1    | Accessory Installation .....                           | 22        |
| 3.8      | Interface Options.....                                 | 23        |
| <b>4</b> | <b>Technical Specifications .....</b>                  | <b>24</b> |
| 4.1      | Operating Ranges .....                                 | 24        |
| 4.2      | Operating Modes .....                                  | 24        |
| 4.3      | Protection Modes.....                                  | 24        |
| 4.4      | Dynamic Operation Mode .....                           | 25        |
| 4.5      | Metering .....   | 25        |
| 4.6      | Miscellaneous .....                                    | 25        |
| 4.7      | AC Input & Cooling .....                               | 25        |
| 4.8      | Dimensions & Weight .....                              | 26        |
| 4.9      | Environmental .....                                    | 26        |
| 4.10     | Voltage versus Current Operating Envelope Charts.....  | 27        |
| 4.10.1   | Model 41L0630 V-I Curves .....                         | 28        |
| 4.10.2   | Model 41L0660 V-I Curves .....                         | 29        |
| 4.10.3   | Model 41L2512 V-I Curves .....                         | 30        |
| 4.10.4   | Model 41L5012 V-I Curves .....                         | 31        |
| 4.10.5   | Model 41L0615 V-I Curves .....                         | 32        |
| <b>5</b> | <b>Unpacking and Installation .....</b>                | <b>33</b> |
| 5.1      | Inspection .....                                       | 33        |
| 5.2      | Load Module Installation and Removal in Mainframe..... | 33        |
| 5.2.1    | Module Removal .....                                   | 33        |
| 5.2.2    | Module Installation .....                              | 34        |
| 5.3      | Cleaning.....  | 35        |
| 5.4      | Powering Up .....                                      | 35        |

|          |   |           |
|----------|---|-----------|
| 5.5      | In Case of Malfunction .....  | 35        |
| 5.6      | Load Connections .....  | 36        |
| 5.7      | Analog Programming Input.....                                       | 37        |
| 5.8      | Load Current Slew Rate.....   | 38        |
| <b>6</b> | <b>Front Panel Operation .....</b>                                  | <b>40</b> |
| 6.1      | Front Panel Layout .....  | 40        |
| 6.2      | User Controls and Readouts .....                                    | 41        |
| 6.3      | Operating Flowchart for 41L Series Load Modules .....               | 60        |
| 6.4      | Go/NoGo LIMIT Testing .....   | 61        |
| 6.4.1    | Limits .....  | 61        |
| 6.4.2    | Go/NoGo Testing in CC Mode.....                                     | 61        |
| 6.4.3    | Go/NoGo Testing in CC Dynamic Mode .....                            | 62        |
| 6.4.4    | Go/NoGo Testing in CR Mode.....                                     | 62        |
| 6.4.5    | Go/NoGo Testing in CV Mode .....                                    | 63        |
| 6.4.6    | Go/NoGo Testing in CP Mode.....                                     | 63        |
| 6.5      | MPPT Mode .....   | 64        |
| 6.5.1    | PV Panel Maximum Power Point.....                                   | 64        |
| 6.5.2    | DC Load vs Inverter MPPT Algorithms.....                            | 64        |
| 6.5.3    | Load MPPT Algorithm.....  | 64        |
| 6.5.4    | Manual MPPT Mode Operation .....                                    | 66        |
| 6.5.5    | Remote MMPT Programming.....  | 66        |
| 6.6      | Initial Power-on Settings .....                                     | 67        |
| 6.6.1    | Model 41L0630 Initial Settings.....                                 | 67        |
| 6.6.2    | Model 41L0660 Initial Settings.....                                 | 67        |
| 6.6.3    | Model 41L2512 Initial Settings.....                                 | 68        |
| 6.6.4    | Model 41L5012 Initial Settings.....                                 | 68        |
| 6.6.5    | Model 41L0615 Initial Settings.....                                 | 69        |
| <b>7</b> | <b>Load Connections, Applications and Protection Features .....</b> | <b>70</b> |
| 7.1      | INPUT Terminals .....   | 70        |
| 7.1.1    | Banana Jack Connectors.....   | 70        |
| 7.1.2    | Y-hook / Spade Lug Terminals.....                                   | 70        |
| 7.1.3    | Lead Wire Insertion .....   | 70        |
| 7.1.4    | Banana Jack Connector and Spade Lug Terminals.....                  | 70        |
| 7.1.5    | Plug Connector and Lead Wire Insertion .....                        | 71        |
| 7.2      | Wire Size .....   | 71        |
| 7.2.1    | Wire Size Guidelines .....  | 71        |
| 7.3      | Connecting a UUT.....   | 72        |
| 7.4      | Polarity and Ground – Multiple Output Power Supplies.....           | 72        |
| 7.5      | Voltage Sense Input Terminals .....                                 | 73        |
| 7.6      | Current Output Monitor (I-Monitor).....                             | 74        |
| 7.6.1    | Non-Isolated Output .....   | 74        |
| 7.6.2    | Output Impedance .....  | 75        |
| 7.6.3    | Connecting I-Monitor Output to an Oscilloscope.....                 | 76        |
| 7.7      | Parallel Operation.....   | 77        |
| 7.7.1    | Parallel Mode Connection.....                                       | 77        |
| 7.7.2    | Allowable Operating Modes .....                                     | 77        |
| 7.7.3    | Exceptions .....  | 77        |
| 7.8      | Series Operation .....  | 77        |
| 7.9      | Zero-Voltage Loading .....  | 78        |
| 7.10     | Protection Features.....  | 79        |

|                    |   |           |
|--------------------|---|-----------|
| 7.10.1             | Over Voltage Protection.....                          | 79        |
| 7.10.2             | Over Current Protection.....                          | 79        |
| 7.10.3             | Over Power Protection.....                            | 79        |
| 7.10.4             | Over Temperature Protection .....                     | 80        |
| 7.10.5             | Reverse Polarity Protection Indication .....          | 80        |
| <b>8</b>           | <b>Auto Sequence Programming Examples .....</b>       | <b>81</b> |
| 8.1                | Overview .....  | 81        |
| 8.2                | Edit Mode .....                                       | 81        |
| 8.3                | Test Mode.....  | 82        |
| 8.4                | AUTO TEST SEQUENCE Example .....                      | 83        |
| <b>9</b>           | <b>Short Circuit, OPP and OCP Test Examples .....</b> | <b>85</b> |
| 9.1                | Overview .....  | 85        |
| 9.2                | SHORT Test .....                                      | 85        |
| 9.3                | OPP Test.....   | 86        |
| 9.4                | OCP Test.....   | 87        |
| <b>10</b>          | <b>Remote Control Programming.....</b>                | <b>88</b> |
| 10.1               | Overview .....  | 88        |
| <b>11</b>          | <b>Calibration .....</b>                              | <b>89</b> |
| 11.1               | Overview .....  | 89        |
| 11.2               | Calibration Interval .....                            | 89        |
| 11.3               | Calibration Coefficients .....                        | 89        |
| 11.4               | Calibration Procedures.....                           | 89        |
| <b>12</b>          | <b>CE MARK Declaration of Conformity.....</b>         | <b>90</b> |
| <b>13</b>          | <b>RoHS Material Content Declaration.....</b>         | <b>91</b> |
| <b>Index .....</b> |   | <b>94</b> |

## Table of Tables

|   |    |
|---|----|
| Table 3-1: Dynamic Current Mode Parameters.....                 | 16 |
| Table 3-2: Included Accessories .....                           | 21 |
| Table 6-1: Front Panel Display and Keyboard Functions.....      | 59 |
| Table 6-2: MMP Tracking Perturbation and Observation Table..... | 65 |
| Table 6-3: Model 41L0630 Power-on Settings .....                | 67 |
| Table 6-4: Model 41L0660 Power-on Settings .....                | 67 |
| Table 6-5: Model 41L2512 Power-on Settings .....                | 68 |
| Table 6-6: Model 41L5012 Power-on Settings .....                | 68 |
| Table 6-7: Model 41L0615 Power-on Settings .....                | 69 |
| Table 7-1: Load Wire Size Table.....                            | 71 |
| Table 7-2: Multiple Output DC Supply Polarity Connection .....  | 72 |
| Table 9-1: Auto-Test Sequence Example Values .....              | 83 |

## Table of Figures

|  |    |
|--|----|
| Figure 3-1: Dynamic Current Wave Form .....                                    | 15 |
| Figure 3-2: Rise Time Performance Limits .....                                 | 17 |
| Figure 3-3: 41L Series Accessories .....                                       | 21 |
| Figure 3-4: Load and sense connections using Y-hooks/spade lugs .....          | 22 |
| Figure 3-5: Load and sense connections using banana plugs - insertion .....    | 22 |
| Figure 3-6: Load and sense connections using banana plugs - inserted .....     | 23 |
| Figure 5-3: Load Module Removal.....   | 34 |
| Figure 5-4: Location and Pin-out of Analog Programming Input Connector .....   | 37 |
| Figure 5-5: Channel Positions for Analog Input Identification.....             | 37 |
| Figure 5-6: Analog Programming Example .....                                   | 38 |
| Figure 5-7: Effect of Current Slew Rate Settings on Power Supply Testing ..... | 39 |
| Figure 6-1: 44M04 Chassis with 41L0630 Series Loads Front Panel View .....     | 40 |
| Figure 6-2: Front Panel User Controls and Indicators .....                     | 41 |
| Figure 6-3: Operation Flow Chart - 41L Series Load Module.....                 | 60 |
| Figure 6-4: LIMIT Test in CC Mode.....   | 61 |
| Figure 6-5: LIMIT Test in Dynamic CC Mode.....                                 | 62 |
| Figure 6-6: LIMIT Test in CR Mode .....  | 62 |
| Figure 6-7: LIMIT Test in CV Mode .....  | 63 |
| Figure 6-8: LIMIT Test in CP Mode.....   | 63 |
| Figure 6-9: MMP Tracking Perturbation and Observation Chart.....               | 65 |
| Figure 7-1: Doubling wire size using spade lugs .....                          | 71 |
| Figure 7-2: DC Load Connection with Internal Voltage Sense .....               | 73 |
| Figure 7-3: DC Load Connection with External Voltage Sense .....               | 73 |
| Figure 7-4: Equivalent I-Monitor Output Circuit .....                          | 75 |
| Figure 7-5: Correct I-Monitor Connections to UUT and Oscilloscope .....        | 76 |
| Figure 7-6: Incorrect I-Monitor Connections to UUT and Oscilloscope.....       | 76 |
| Figure 7-7: Parallel Load Connection.....                                      | 77 |
| Figure 7-8: Zero Volt Load Connection.....                                     | 78 |
| Figure 9-1: Auto-Test Sequence Example Illustration .....                      | 83 |

## 1 Contact Information

### AMERICA / CANADA

Adaptive Power Systems  
Irvine, USA  
Phone: +1(949) 752-8400  
Fax: +1 (949) 756-0838  
Email: [support@adaptivepower.com](mailto:support@adaptivepower.com)

### EUROPE

Caltest Instruments Ltd.  
Guildford, United Kingdom  
Phone: +44(0)1483 302 700  
Fax: +44(0)1483 300 562  
Email: [support@adaptivepower.com](mailto:support@adaptivepower.com)

### CHINA

PPST Shanghai Co. Ltd.  
Shanghai, China  
Phone: +86-21-6763-9223  
Fax: +86-21-5763-8240  
Email: [support@adaptivepower.com](mailto:support@adaptivepower.com)

Web: <http://www.adaptivepower.com>



## 2 Front Matter

### 2.1 Limited Warranty

Adaptive Power Systems, Inc. (APS) warrants each unit to be free from defects in material and workmanship. For the period of one (1) year from the date of shipment to the purchaser, APS will either repair or replace, at its sole discretion, any unit returned to the APS factory in Irvine, California or one of its designated service facilities. It does not cover damage arising from misuse of the unit or attempted field modifications or repairs. This warranty specifically excludes damage to other equipment connected to this unit.

Upon notice from the purchaser within (30) days of shipment of units found to be defective in material or workmanship, APS will pay all shipping charges for the repair or replacement. If notice is received more than thirty (30) days from shipment, all shipping charges shall be paid by the purchaser. Units returned on debit memos will not be accepted and will be returned without repair.

**This warranty is exclusive of all other warranties, expressed or implied.**

### 2.2 Service and Spare Parts Limited Warranty

APS warrants repair work to be free from defects in material and workmanship for the period of ninety (90) days from the invoice date. This Service and Spare Parts Limited Warranty applies to replacement parts or to subassemblies only. All shipping and packaging charges are the sole responsibility of the buyer. APS will not accept debit memos for returned power sources or for subassemblies. Debit memos will cause return of power sources or assemblies without repair.

**This warranty is exclusive of all other warranties, expressed or implied.**

### 2.3 Safety Information

This chapter contains important information you should read BEFORE attempting to install and power-up APS Equipment. The information in this chapter is provided for use by experienced operators. Experienced operators understand the necessity of becoming familiar with, and then observing, life-critical safety and installation issues. Topics in this chapter include:

- Safety Notices
- Warnings
- Cautions
- Preparation for Installation
- Installation Instructions

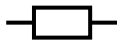

Make sure to familiarize yourself with the **SAFETY SYMBOLS** shown on the next page. These symbols are used throughout this manual and relate to important safety information and issues affecting the end user or operator.

**SAFETY SYMBOLS****Direct current (DC)****Alternating current (AC)****Both direct and alternating current****Three-phase alternating current****Protective Earth (ground) terminal****On (Supply)****Off (Supply)****Fuse****Caution: Refer to this manual before this Product.****Caution, risk of electric shock**

## 2.4 Safety Notices

### **SAFETY SUMMARY**

The following general safety precautions must be observed during all phases of operation, service, and repair of this instrument. Failure to comply with these precautions or with specific warnings elsewhere in this manual violates safety standards of design, manufacture, and intended use of the instrument. Adaptive Power Systems assumes no liability for the customer's failure to comply with these requirements.

### **GENERAL**

This product is a Safety Class 1 instrument (provided with a protective earth terminal). The protective features of this product may be impaired if it is used in a manner not specified in the operation instructions.

### **ENVIRONMENTAL CONDITIONS**

This instrument is intended for indoor use in an installation category I, pollution degree 2 environments. It is designed to operate at a maximum relative humidity of 80% and at altitudes of up to 2000 meters. Refer to the specifications tables for the ac mains voltage requirements and ambient operating temperature range.

### **BEFORE APPLYING POWER**

Verify that the product is set to match the available line voltage and the correct fuse is installed.

### **GROUND THE INSTRUMENT**

This product is a Safety Class 1 instrument (provided with a protective earth terminal). To minimize shock hazard, the instrument chassis and cabinet must be connected to an electrical ground. The instrument must be connected to the AC power supply mains through a properly rated three-conductor power cable, with the third wire firmly connected to an electrical ground (safety ground) at the power outlet. Any interruption of the protective (grounding) conductor or disconnection of the protective earth terminal will cause a potential shock hazard that could result in personal injury.

### **FUSES**

Only fuses with the required rated current, voltage, and specified type (normal blow, time delay, etc.) should be used. Do not use repaired Fuses or short circuit the fuse holder. To do so could cause a shock or fire hazard.

### **DO NOT OPERATE IN AN EXPLOSIVE ATMOSPHERE.**

Do not operate the instrument in the presence of flammable gases or fumes.

**KEEP AWAY FROM LIVE CIRCUITS.**

Operating personnel must not remove instrument covers. Component replacement and internal adjustments must be made by qualified service personnel. Do not replace components with power cable connected. Under certain conditions, dangerous voltages may exist even with the power cable removed. To avoid injuries, always disconnect power, discharge circuits and remove external voltage sources before touching components.

**DO NOT SERVICE OR ADJUST ALONE.**

Do not attempt internal service or adjustment unless another person, capable of rendering first aid and resuscitation, is present.

**DO NOT EXCEED INPUT RATINGS.**

This instrument may be equipped with a line filter to reduce electromagnetic interference and must be connected to a properly grounded receptacle to minimize electric shock hazard. Operation at line voltages or frequencies in excess of those stated on the data plate may cause leakage currents in excess of 5.0 mA peak.

**DO NOT SUBSTITUTE PARTS OR MODIFY INSTRUMENT.**

Because of the danger of introducing additional hazards, do not install substitute parts or perform any unauthorized modification to the instrument. Return the instrument to an Adaptive Power Systems Sales and Service Office for service and repair to ensure that safety features are maintained.

Instruments that appear damaged or defective should be made inoperative and secured against unintended operation until they can be repaired by qualified service personnel.

## 3 Product Overview

This chapter provides an overview of the APS 41L Series modular programmable DC loads. It introduces the reader to general operating characteristics of these loads.

### 3.1 General Description

The APS 41L Series modular electronic loads are designed to perform test, evaluation and burn-in of DC power supplies and batteries.

The 41L Series of electronic load modules are operated from within a suitable mainframe. The 44M01, 44M02 and 44M04 mainframes allow 1, 2 or 4 modules to be operated at the same time. The mainframes provide the necessary mains power conversion along with computer and analogue interfaces. Front panel memory store and recall functions are provided. A total of 150 memory locations are available to store the set-up of the load modules within a mainframe. It is also possible to program and recall a test sequence consisting of different steps against time. Please refer to the separate 44M01, 44M02 and 44M04 operating manuals for the mainframe functions.

Mainframe model 44M01: P/N 160901-10

Mainframe model 44M02: P/N 160902-10

Mainframe model 44M04: P/N 160904-10

The APS 41L Series can be operated from the front panel (manual mode) or using RS232, USB, LAN (Ethernet) or GPIB remote control.

The VI curve constant power contours of the various 41L Series modules are shown in the Technical Specification Section. All models have dual range capability for enhanced accuracy and resolution at lower power levels. Maximum current and power capability depends on the specific module type.

### 3.2 Operating Modes

Available operating modes for all models are:

- Constant Current (CC) mode
- Constant Resistance (CR) mode
- Constant Voltage (CV) mode
- Constant Power (CP) mode.

A more detailed explanation of each mode and under what condition each mode is most appropriate to use follows.

### 3.2.1 Constant Current Mode

This is the most commonly used mode of operating when testing a voltage source such as a DC power supply, battery, AC/DC converter or ADC. In this mode of operation, the load will sink a constant level of current as set by the user, regardless of any voltage variations. A real time feedback loop ensures a stable current under any voltage variation of the DC supply or battery.

This mode is recommended for load regulation testing, loop stability testing, battery discharge testing and any other form of voltage regulation loop testing.

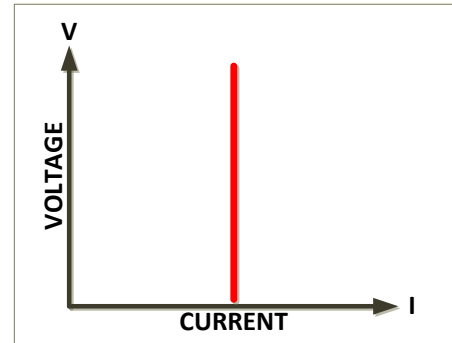

### 3.2.2 Constant Resistance Mode

In Constant Resistance mode, the load will sink current directly proportional to the sensed DC input voltage. The ratio between DC voltage and current is linear per ohms law and can be set by the user within the operating range of the DC load. The current is defined by the formula shown here where R is the set value in CR mode and V is the dc input voltage from the unit under test.

$$I = V/R$$

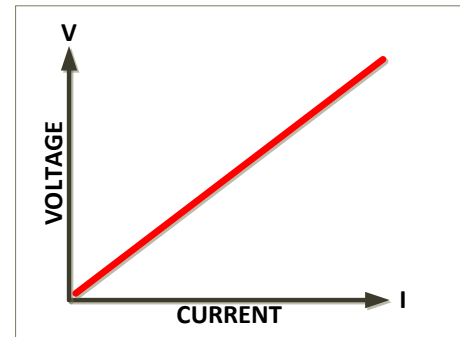

CR mode is useful for battery discharge testing of battery systems used to power constant impedance loads as the voltage will decrease as the battery discharges over time resulting in reduced current sinking.

### 3.2.3 Constant Voltage Mode

In Constant Voltage mode, the load will attempt to sink as much current as needed to reach the programmed voltage setting. This mode should only be used with current controlled DC power sources.

**Note:** Most DC power supplies are voltage controlled, i.e. they regulate the output voltage to a predefined voltage level. Such DC voltage supplies should not be tested using CV mode as the DC supply voltage regulation loop will conflict with the DC load control loop.

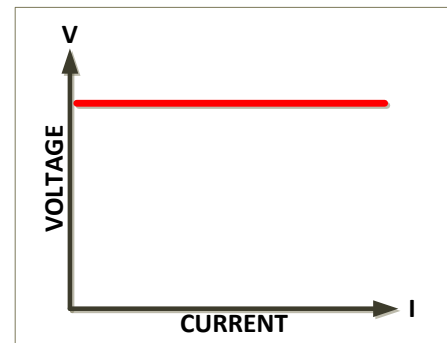

### 3.2.4 Constant Power Mode

In Constant Power mode, the DC load will attempt to maintain the programmed Power dissipation by sinking more or less current at the voltage sensed. The current is defined by the formula shown below.

$$I = P/V$$

Constant power mode is useful for battery discharge testing as it simulates constant power drain on the battery, regardless of battery charge state.

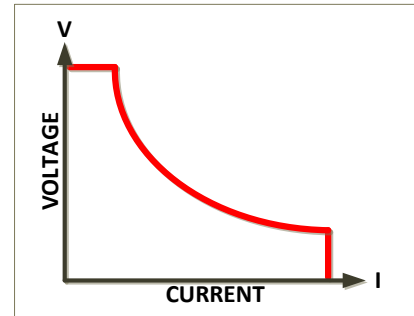

### 3.3 Static versus Dynamic Operating Modes

The 41L Series supports both STATIC and DYNAMIC CC mode. Static mode uses a constant load level whereas dynamic mode allows rapid changes between two pre-set current sink levels using programmable current slew rates and duty cycle.

Static Constant Current mode presents a static load condition as the load current remains constant. This tests load regulation of a DC power supply under steady state operating conditions.

To test voltage regulation under dynamic load conditions, specific changes in current level and current slew rates must be applied to the DC supply under test. The dynamic CC mode is provided for this application.

The 41L Series offer a wide range of dynamic load conditions with independent rise and fall current slew rate programming in Constant Current mode.

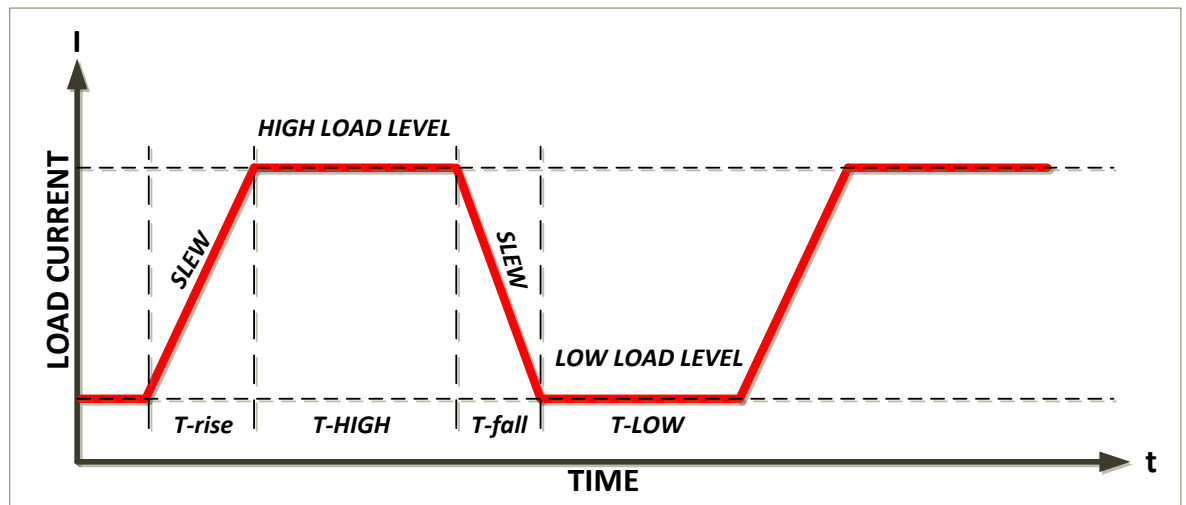

Figure 3-1: Dynamic Current Wave Form

### 3.3.1 Programmable Parameters

There are six programmable parameters to generate dynamic wave form or pulse wave form, the 41L Series loads will sink current from power source proportional to the dynamic wave form, the dynamic wave form definition is shown in Figure 3-1. Available settings are:

| Parameter                | Description                                | Type            |
|--------------------------|--|-----------------|
| <b>Current High</b>      | Highest programmed load current            | Current Setting |
| <b>Current Low</b>       | Lowest programmed load current             | Current Setting |
| <b>T-High</b>            | Duration at High current setting           | Time (secs)     |
| <b>T-Low</b>             | Duration at Low current setting            | Time (secs)     |
| <b>Rising Slew Rate</b>  | Current Slew Rate from Low to High Current | A/sec           |
| <b>Falling Slew Rate</b> | Current Slew Rate from High to Low Current | A/sec           |

Table 3-1: Dynamic Current Mode Parameters

The resulting Current Waveform has the following characteristics:

$$\text{Period} = T\text{-High} + T\text{-Low}$$

$$\text{Frequency} = 1 / ( T\text{-High} + T\text{-Low} )$$

$$\text{Duty Cycle} = T\text{-High} / ( T\text{-High} + T\text{-Low} )$$

### 3.3.2 Slew Rates

Slew rate is defined as the change in current or voltage over time. A programmable slew rate allows a controlled transition from one load setting to another to minimize induced voltage drops on inductive power wiring, or to control induced transients on a test device (such as would occur during power supply transient response testing).

In cases where the transition from one setting to another is large, the actual transition time can be calculated by dividing the voltage or current transition by the slew rate. The actual transition time is defined as the time required for the input to change from 10% to 90% or from 90% to 10% of the programmed current excursion. In cases where the transition from one setting to another is small, the small signal bandwidth of the load limits the minimum transition time for all programmable slew rates. Because of this limitation, the actual transition time is typically longer than the expected time based on the slew rate setting, as shown in Figure 3-2.

Therefore, both minimum transition time and slew rate must be considered when determining the actual transition time. *See also section 5.13 “Load Current Slew Rate” on page 38.*



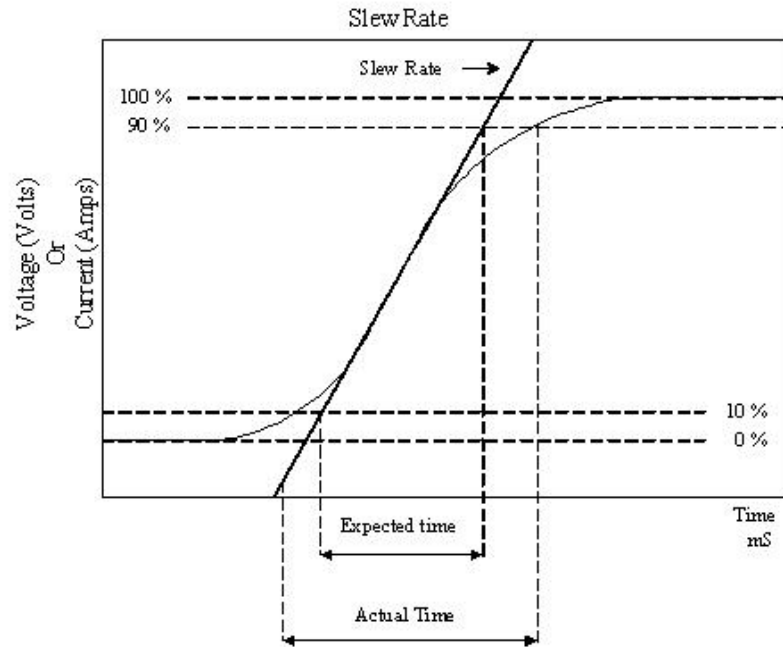

Figure 3-2: Rise Time Performance Limits

### 3.3.3 Determining Actual Transition Times

The minimum transition time ( $Tr_{min}$ ) for a given slew rate applies for smaller changes in current as a percent of current range. At about a 30% or greater load change, the slew rate starts to increase from the minimum transition time to the maximum transition time ( $Tr_{max}$ ) at a 100% load change. The actual transition time will be either the minimum transition time, or the total slew time (T-fall or T-rise) divided by the current slew rate, whichever is longer.

#### Minimum $Tr$

Use the following formulas to calculate the minimum transition time for a given slew rate on a 41L0660 module:

Maximum current range for this module is 60A so 30% of 60 = 18. The minimum required slew rate can be calculated as follows:

$$Tr_{min} = \frac{18}{\text{slew rate (A/}\mu\text{s)}} * \frac{(90\% - 10\%)}{100\%} \mu\text{s}$$

Which is equivalent to:

$$Tr_{min} = \frac{18}{\text{slew rate (A/}\mu\text{s)}} * 0.8 \mu\text{s}$$

For a programmed slew rate of 0.1A/ $\mu$ s, this results in:

$$Tr_{min} = \frac{18}{0.1} * 0.8 \mu\text{s} = 144 \mu\text{s}$$

#### Example 1:

Assume high current level (CCH) = 16A and low current level (CCL) = 0A. For a 41L0660, a 16A delta change in current represents less than 30% of full scale current this load module (< 18A). If the programmed slew rate is set to 0.1A/μs, the expected transition time would be:

$$Tr = \frac{0.8 * (16 - 0)}{0.1} \mu s = 128 \mu s$$

However, we determined that  $Tr_{min}$  for a slew rate of 0.1A/μs is at least 144 μs so the actual transition time will be limited to no less than 144 μs.

### Maximum $Tr$

Use the following formula to calculate the maximum transition time for a given slew rate:

$$Tr_{max} = \frac{60(\text{Max.Current})}{\text{slew rate (A/}\mu\text{s)}} * 0.8 \mu s$$

For a slew rate of 0.1A/μs, this results in:

$$Tr_{max} = \frac{60}{0.1} * 0.8 \mu s = 480 \mu s$$

### Example 2:

Assume high current level (CCH) = 40A and low current level (CCL) = 0A. Since 40A represents more than 30% of the current range for the module used (40 > 18). If the slew rate is set to 0.1A/μs, the expected transition time would be:

$$Tr = \frac{0.8 * (40 - 0)}{0.1} \mu s = 320 \mu s$$

Since  $Tr_{max}$  for a slew rate of 0.1A/μs is 480 μs so the actual transition time will be lesser of these two values or 320 μs.

### 3.4 Current Read-back

The load current levels and load status can be set from the front panel of each load module or over the remote control interface. During testing, load input voltage and load current can be read back but the current read back will typically display the average current level unless the dynamic current frequency setting is low enough. An analog current monitor output is provided to allow capturing of dynamic current on a digital storage scope or data recorder.

### 3.5 Analog Input Mode

A set of analog inputs is provided at the rear panel of the mainframe to allow analog programming of load current using a function or arbitrary waveform generator. This allows any current profile within the performance envelope of the DC load to be used for perform dynamic load testing beyond the built in dynamic CC mode.

**Note:** This mode is supported in Constant Current (CC) and Constant Power (CP) modes only.

### 3.6 Product Features

The following key characteristics apply to all 41L Series modules.

- Fully programmable electronic DC load with flexible configuration and dual range capabilities.
- Full remote control of all load settings and metering read back.
- Dual high accuracy and high-resolution 5 digit voltage and current meters.
- Built-in pulse generator includes wide Thigh/Tlow dynamic load range, independent Rise/Fall load current slew rate control, and High/Low load level.
- Controllable load current slew rate of load level change,
- Load ON/OFF switch change and power supply turn ON.
- Short circuit test with current measure capability.
- Dedicated over current and over power protection test functions
- Automatic voltage sensing and external sense.
- Full protection from over power, over temperature, over voltage, and reverse polarity.
- Analog programming input
- Current monitor output signal (non-isolated)
- Variable fan speed control for quieter operation

### 3.7 Accessories Included

The following accessories are included with each 41L Series DC Load in the quantities shown in the table below. If one or more of these items is missing upon incoming inspection of the product, please contact Adaptive Power Systems customer service.

| Item | Description  | 41L | 42L | 41D | 42D |
|------|--|-----|-----|-----|-----|
| a    | Banana plug, 4 mm, Red – Load connection                 | 1   | 2   | 1   | -   |
| b    | Banana plug, 4 mm, Black – Load connection               | 1   | 2   | 1   | -   |
| c    | Banana plug, 2 mm, Red – V <sub>SENSE</sub> connection   | 1   | 2   | 3   | 8   |
| d    | Banana plug, 2 mm, Black – V <sub>SENSE</sub> connection | 1   | 2   | 3   | 8   |
| e    | Y-hook Terminal, Large – Load connection                 | 2   | -   | -   | -   |
| f    | Y-hook Terminal, Small – V <sub>SENSE</sub> connection   | 2   | 4   | 4   | 4   |
| g    | BNC Cable, 3 feet – I Monitor                            | 1   | -   | 1   | -   |
| h    | Operator Manual in Hardcopy format or PDF on CD ROM      | 1   | 1   | 1   | 1   |
| i    | Certificate of Conformance                               | 1   | 1   | 1   | 1   |

Table 3-2: Included Accessories

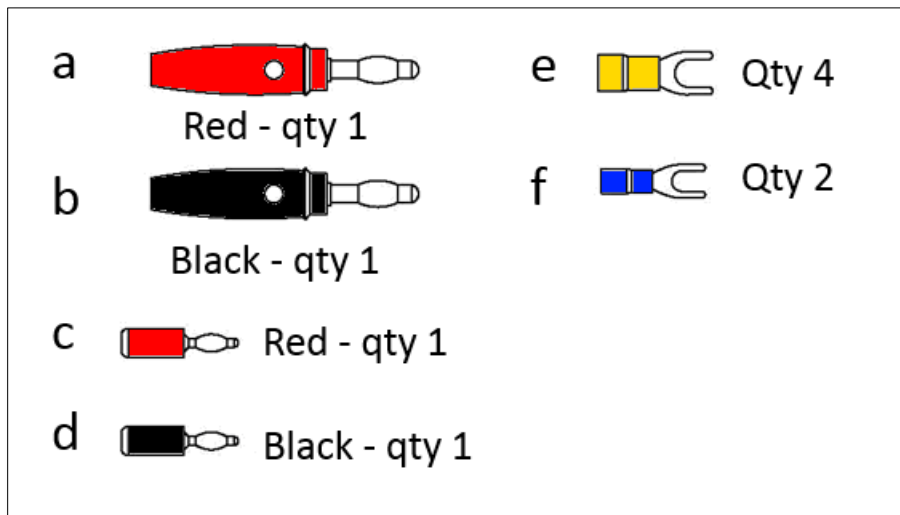

Figure 3-3: 41L Series Accessories

### 3.7.1 Accessory Installation

Several connectors are included in the 41L ship kit to allow connection of load and sense wires to equipment unit under test (EUT). The following illustrations show how these connectors can be used to connect a load. Note that for lower impedance connections as may be desirable in high current applications, use of the banana jacks and Y-hooks (spade lugs) can be combined.

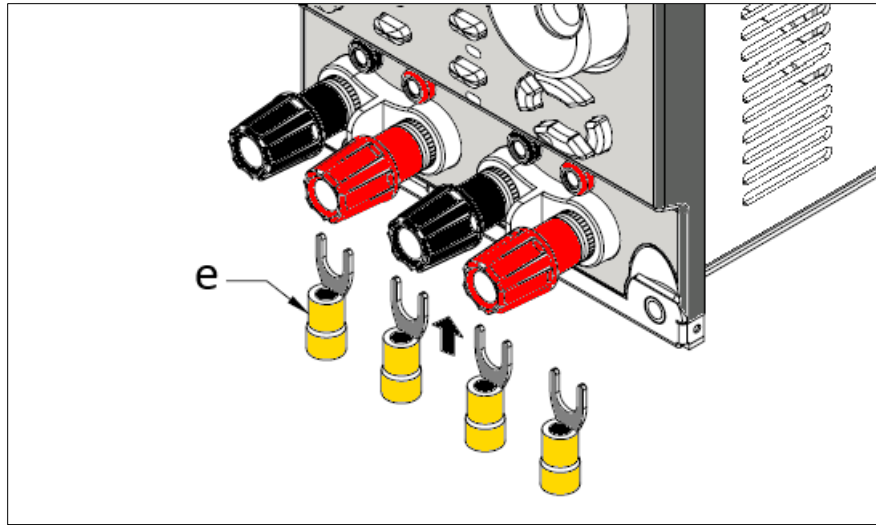

Figure 3-4: Load and sense connections using Y-hooks/spade lugs

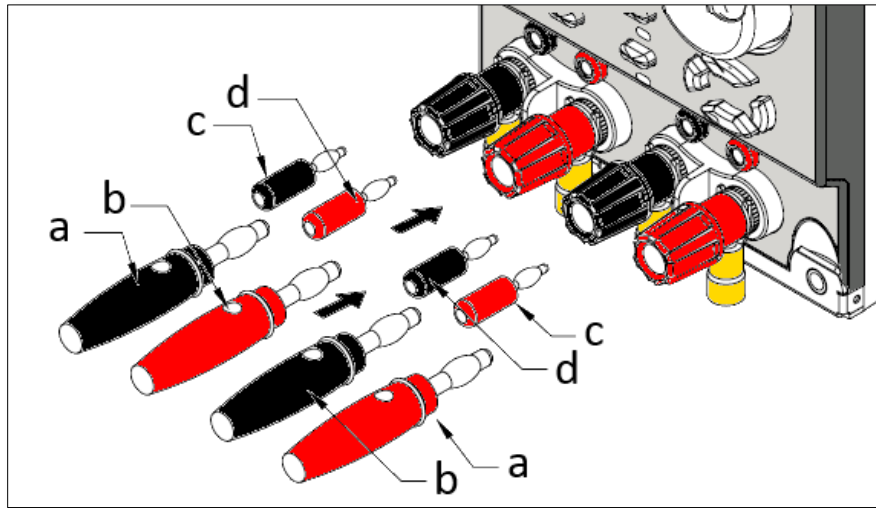
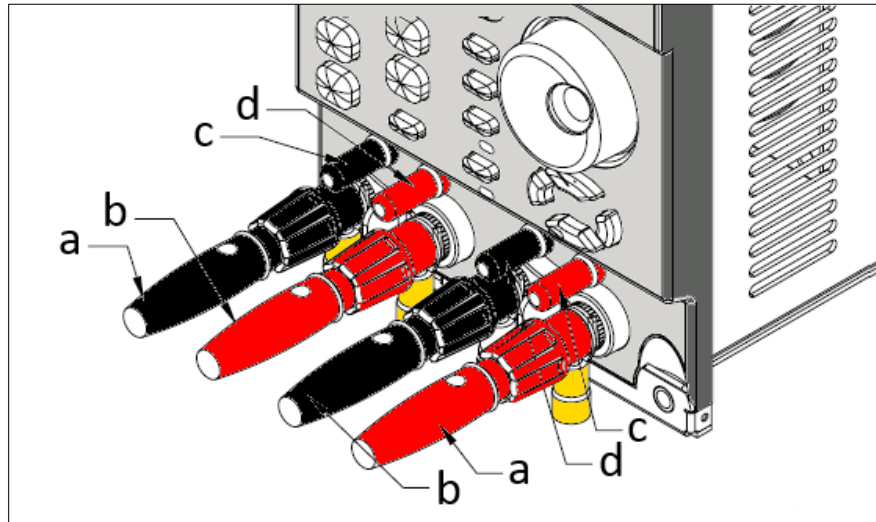

Figure 3-5: Load and sense connections using banana plugs - insertion



*Figure 3-6: Load and sense connections using banana plugs - inserted*

### 3.8 Interface Options

Refer to mainframe manual for list of available interface options.

## 4 Technical Specifications

Technical specifications shown here apply at an ambient temperature of 25° C ± 5°. Refer to V-I curve and Very Low Voltage V-I Curve charts by models for operating envelope.

### 4.1 Operating Ranges

| MODEL           | 41L0630    |         | 41L0660    |         | 41L2512    |         | 41L5012    |         | 41L0615    |        |
|-----------------|------------|---------|------------|---------|------------|---------|------------|---------|------------|--------|
| Power Ranges    | 0-15 W     | 0-150 W | 0-30 W     | 0-300 W | 0-30 W     | 0-300 W | 0-30 W     | 0-300 W | 0-7.5 W    | 0-75 W |
| Current Ranges  | 0-3 A      | 0-30 A  | 0-6 A      | 0-60 A  | 0-1.2 A    | 0-12 A  | 0-1.2 A    | 0-12 A  | 0-1.5 A    | 0-15 A |
| Voltage Range   | 0 - 60 V   |         | 0 - 60 V   |         | 0 - 60 V   |         | 0 - 60 V   |         | 0 - 60 V   |        |
| Minimum Voltage | 0.6V @ 30A |         | 0.6V @ 60A |         | 1.0V @ 12A |         | 6.0V @ 12A |         | 0.3V @ 15A |        |

### 4.2 Operating Modes

| MODEL           | 41L0630    |                              | 41L0660  |           | 41L2512    |            | 41L5012   |            | 41L0615   |           |          |
|-----------------|------------|------------------------------|----------|-----------|------------|------------|-----------|------------|-----------|-----------|----------|
| OPERATING MODES |            |                              |          |           |            |            |           |            |           |           |          |
| CC Mode         | Range      | 0-3 A                        | 0-30 A   | 0-6 A     | 0-60 A     | 0-1.2 A    | 0-12 A    | 0-1.2 A    | 0-12 A    | 0-1.5 A   | 0-15 A   |
|                 | Resolution | 0.05 mA                      | 0.5 mA   | 0.1 mA    | 1 mA       | 0.02 mA    | 0.2 mA    | 0.02 mA    | 0.2 mA    | 0.0254mA  | 0.25 mA  |
|                 | Accuracy   | ± 0.1% OF (SETTING + RANGE)  |          |           |            |            |           |            |           |           |          |
| CR Mode         | Range      | 2-120kΩ                      | 0.02-2Ω  | 1-60kΩ    | 0.00833-1Ω | 25-1500kΩ  | 0.08-25Ω  | 50-3000kΩ  | 0.5-50Ω   | 4-240kΩ   | 0.02-4Ω  |
|                 | Resolution | 0.00833mS                    | 33.334μΩ | 0.01666mS | 16.667μΩ   | 0.000666mS | 416.667μΩ | 0.000333mS | 833.334μΩ | 0.04166mS | 66.667μΩ |
|                 | Accuracy   | ± 0.2% OF (SETTING + RANGE)  |          |           |            |            |           |            |           |           |          |
| CV Mode         | Range      | 0-6 V                        | 0-60 V   | 0-6V      | 0-60V      | 0-30V      | 0-250 V   | 0-60 V     | 0-500 V   | 0-6 V     | 0-60 V   |
|                 | Resolution | 0.1 mV                       | 1 mV     | 0.1 mV    | 1 mV       | 1 mV       | 10 mV     | 1 mV       | 10 mV     | 0.1 mV    | 1 mV     |
|                 | Accuracy   | ± 0.05% OF (SETTING + RANGE) |          |           |            |            |           |            |           |           |          |
| CP Mode         | Range      | 0-15 W                       | 0-150 W  | 0-30 W    | 0-300 W    | 0-30 W     | 0-300 W   | 0-30 W     | 0-300 W   | 0-7.5 W   | 0-75 W   |
|                 | Resolution | 0.25 mW                      | 2.5 mW   | 1 mW      | 10 mW      | 1 mW       | 10 mW     | 1 mW       | 10 mW     | 0.125 mW  | 1.25 mW  |
|                 | Accuracy   | ± 0.5% OF (SETTING + RANGE)  |          |           |            |            |           |            |           |           |          |

### 4.3 Protection Modes

| MODEL                 | 41L0630          |  | 41L0660 |  | 41L2512 |  | 41L5012 |  | 41L0615 |  |
|-----------------------|------------------|--|---------|--|---------|--|---------|--|---------|--|
| PROTECTION            |                  |  |         |  |         |  |         |  |         |  |
| Over Power (OP)       | 157.5 W          |  | 315.0 W |  | 315.0 W |  | 315.0 W |  | 78.75 W |  |
| Over Current (OC)     | 31.5 A           |  | 63.0 A  |  | 12.6 A  |  | 12.6 A  |  | 15.75 A |  |
| Over Voltage (OV)     | 63.0 V           |  | 63.0 V  |  | 262.5 V |  | 525.0 V |  | 63.0 V  |  |
| Over Temperature (OT) | +85° C / +185° F |  |         |  |         |  |         |  |         |  |



#### 4.4 Dynamic Operation Mode

| MODEL                    | 41L0630                              | 41L0660             | 41L2512           | 41L5012             | 41L0615            |                   |                    |                   |                      |                      |
|--------------------------|--------------------------------------|---------------------|-------------------|---------------------|--------------------|-------------------|--------------------|-------------------|----------------------|----------------------|
| <b>DYNAMIC OPERATION</b> |                                      |                     |                   |                     |                    |                   |                    |                   |                      |                      |
| T high & T low           | 50 $\mu$ s TO 9.999 s (20 kHz)       |                     |                   |                     |                    |                   |                    |                   |                      |                      |
| Slew Rate                | 2.0-125 mA/ $\mu$ s                  | 20-1250 mA/ $\mu$ s | 4-250 mA/ $\mu$ s | 40-2500 mA/ $\mu$ s | 0.8-50 mA/ $\mu$ s | 8-500 mA/ $\mu$ s | 0.8-50 mA/ $\mu$ s | 8-500 mA/ $\mu$ s | 1.0-62.5 mA/ $\mu$ s | 10.0-625 mA/ $\mu$ s |
| Accuracy                 | $\pm$ 5% OF SETTING $\pm$ 10 $\mu$ s |                     |                   |                     |                    |                   |                    |                   |                      |                      |

#### 4.5 Metering

| MODEL           | 41L0630                           | 41L0660    | 41L2512   | 41L5012    | 41L0615    |            |           |            |           |            |
|-----------------|-----------------------------------|------------|-----------|------------|------------|------------|-----------|------------|-----------|------------|
| <b>METERING</b> |                                   |            |           |            |            |            |           |            |           |            |
| Voltage Range   | 0 - 6.0 V                         | 0 - 60.0 V | 0 - 6.0 V | 0 - 60.0 V | 0 - 30.0 V |            |           |            |           |            |
| Resolution      | 0.1 mV                            | 1 mV       | 0.1 mV    | 1 mV       | 0.1 mV     |            |           |            |           |            |
| Accuracy        | $\pm$ 0.025% OF (READING + RANGE) |            |           |            |            |            |           |            |           |            |
| Current Range   | 0- 3.0 A                          | 0- 30.0 A  | 0 - 6.0 A | 0- 60.0 A  | 0 - 1.2 A  | 0 - 12.0 A | 0 - 1.2 A | 0 - 12.0 A | 0 - 1.5 A | 0 - 15.0 A |
| Resolution      | 0.1 mA                            | 1 mA       | 0.1 mA    | 1 mA       | 0.02 mA    | 0.2 mA     | 0.02 mA   | 0.2 mA     | 0.025 mA  | 0.25 mA    |
| Accuracy        | $\pm$ 0.1% OF (READING + RANGE)   |            |           |            |            |            |           |            |           |            |
| Power Range     | 0-15 W                            | 0-150 W    | 0-30 W    | 0-300 W    | 0-30 W     | 0-300 W    | 0-30 W    | 0-300 W    | 0-7.5 W   | 0-75 W     |
| Resolution      | 0.1 W                             |            |           |            |            |            |           |            |           |            |

#### 4.6 Miscellaneous

| MODEL                    | 41L0630  | 41L0660        | 41L2512       | 41L5012      | 41L0615       |
|--------------------------|--|----------------|---------------|--------------|---------------|
| <b>SHORT CIRCUIT</b>     |  |                |               |              |               |
| Typical Short Resistance | 20 m $\Omega$                                      | 8.3 m $\Omega$ | 80 m $\Omega$ | 0.5 $\Omega$ | 20 m $\Omega$ |
| Max. Short Current       | 30 A   | 60 A           | 12 A          | 12 A         | 15 A          |
| <b>ANALOG I/O</b>        |  |                |               |              |               |
| Analog Monitor Out       | 0 - 10 V out F.S. / 1K $\Omega$ Zout, Non-isolated |                |               |              |               |
| Accuracy                 | $\pm$ 0.5% OF (SETTING + RANGE)                    |                |               |              |               |
| Analog Input (CC mode)   | 0 - 10V in for F.S. current @ 10V                  |                |               |              |               |

#### 4.7 AC Input & Cooling

| MODEL                                      | 41L0630                     | 41L0660 | 41L2512 | 41L5012 | 41L0615 |
|--|-----------------------------|---------|---------|---------|---------|
| <b>AC INPUT AND COOLING SPECIFICATIONS</b> |                             |         |         |         |         |
| AC Power                                   | Supplied by 44MOX Mainframe |         |         |         |         |
| Cooling                                    | Supplied by 44MOX Mainframe |         |         |         |         |

## 4.8 Dimensions & Weight

| MODEL                        | 41L0630                                   | 41L0660          | 41L2512          | 41L5012          | 41L0615          |
|------------------------------|---|------------------|------------------|------------------|------------------|
| <b>DIMENSIONS AND WEIGHT</b> |   |                  |                  |                  |                  |
| Dimensions (H x W x D)       | 143 x 108 x 412 mm / 5.6" x 4.25" x 16.2" |                  |                  |                  |                  |
| Weight (Net)                 | 3.7 kg / 8.2 lbs                          | 3.7 kg / 8.2 lbs | 3.7 kg / 8.2 lbs | 3.7 kg / 8.2 lbs | 3.7 kg / 8.2 lbs |

## 4.9 Environmental

| MODEL                 | 41L0630                               | 41L0660 | 41L2512 | 41L5012 | 41L0615 |
|-----------------------|---------------------------------------|---------|---------|---------|---------|
| <b>ENVIRONMENTAL</b>  |                                       |         |         |         |         |
| Operating Temperature | 0 - 40° C / 32 - 104° F               |         |         |         |         |
| Relative Humidity     | 80% max. non-condensing               |         |         |         |         |
| Environmental         | Indoor Use Only, Pollution Degree 2   |         |         |         |         |
| Altitude              | 2000 meter / 6500 feet max. Operating |         |         |         |         |
| EMC & Safety          | CE Mark                               |         |         |         |         |

#### 4.10 Voltage versus Current Operating Envelope Charts

Following charts show constant power operating envelopes for each module. For operation at voltages below 1.0 Vdc, refer to the Low Voltage Operating charts. Operation below the red line shown in these charts is not specified.

Charts are shown by model on following pages.

4.10.1 Model 41L0630 V-I Curves

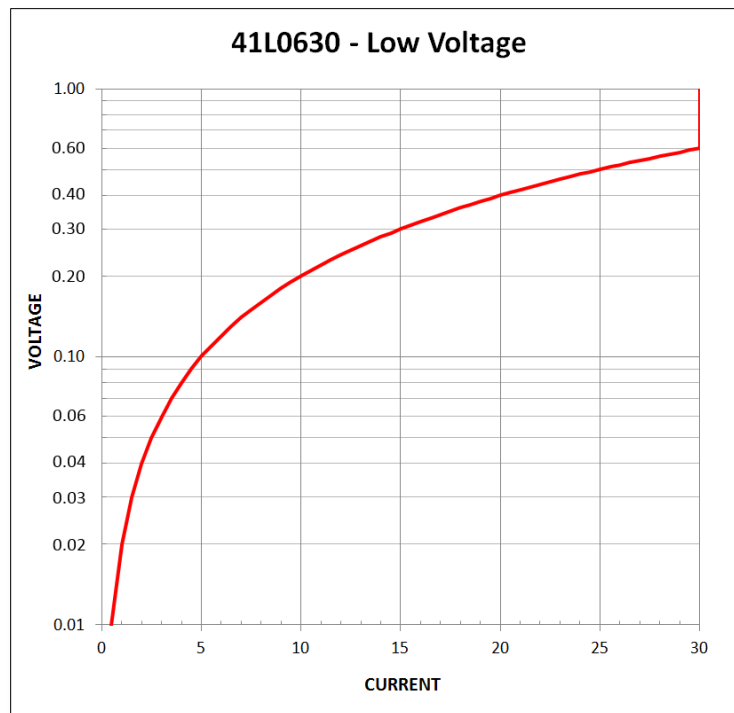
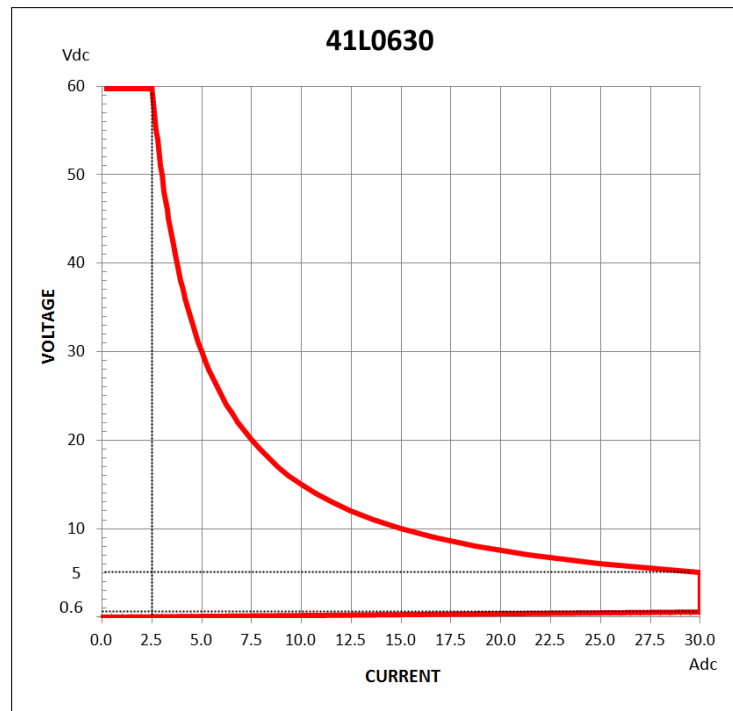

4.10.2 Model 41L0660 V-I Curves

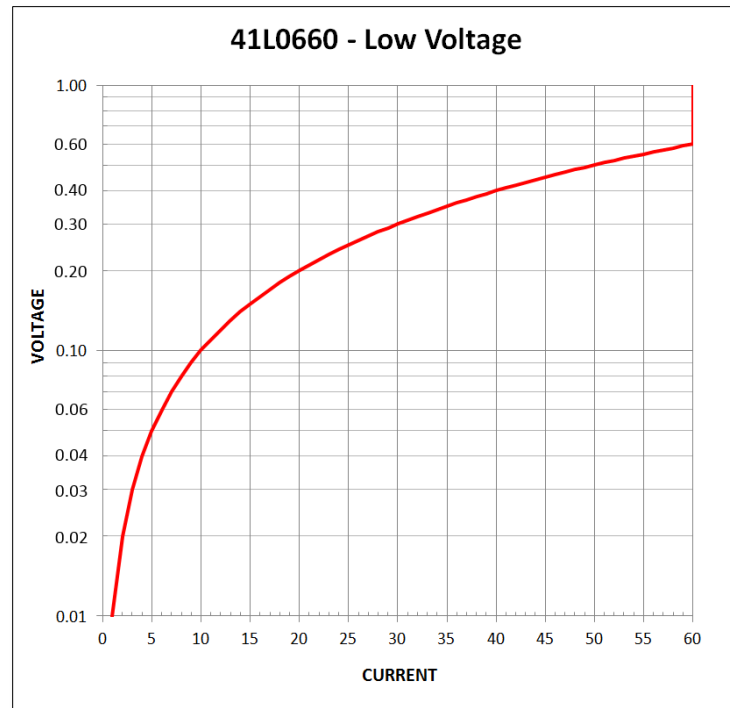
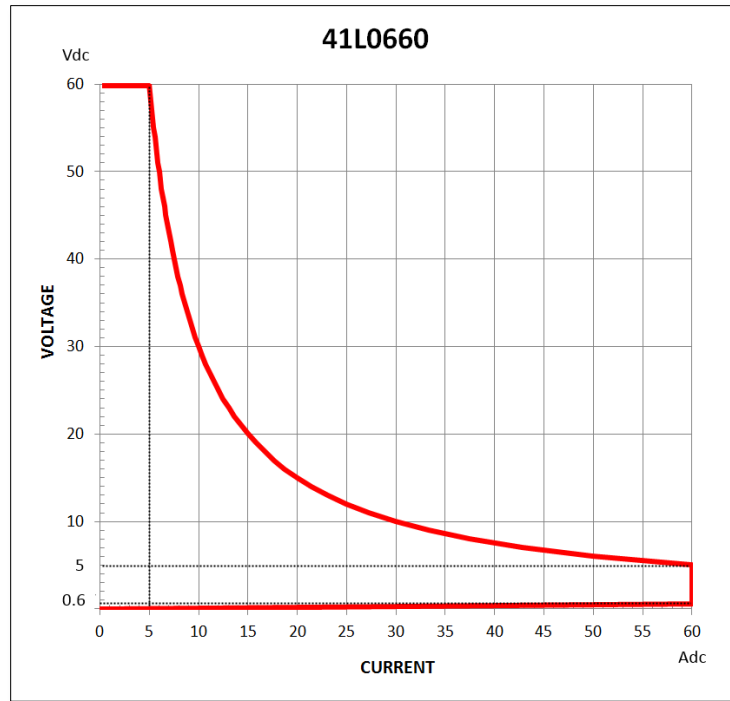

4.10.3 Model 41L2512 V-I Curves

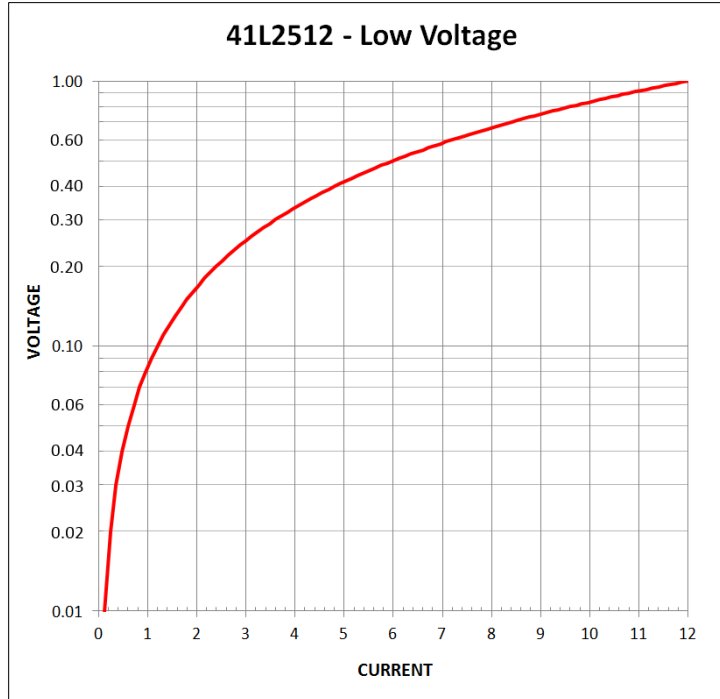
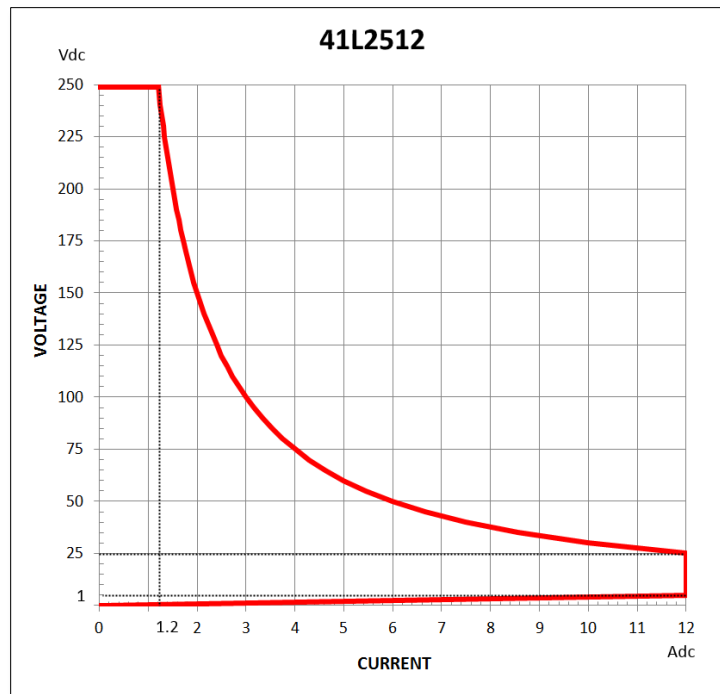

4.10.4 Model 41L5012 V-I Curves

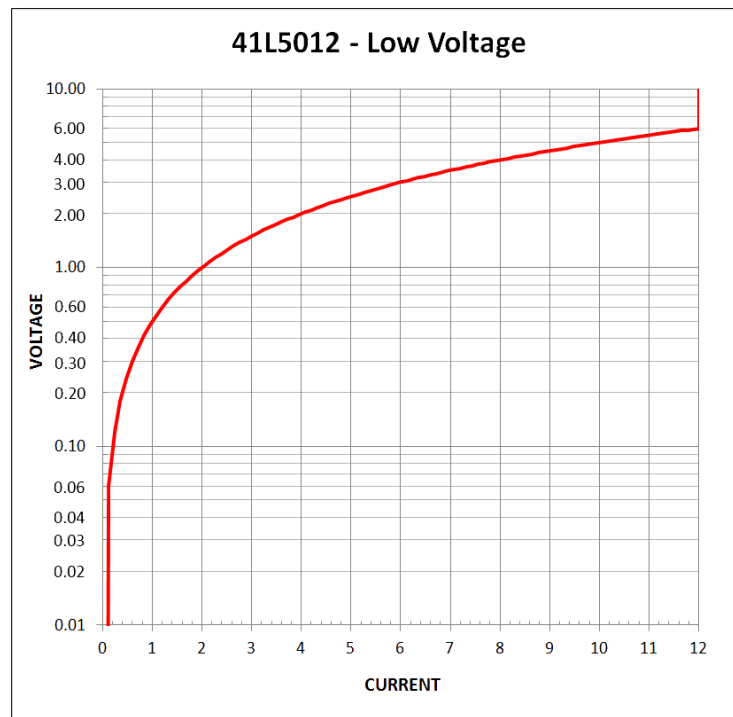
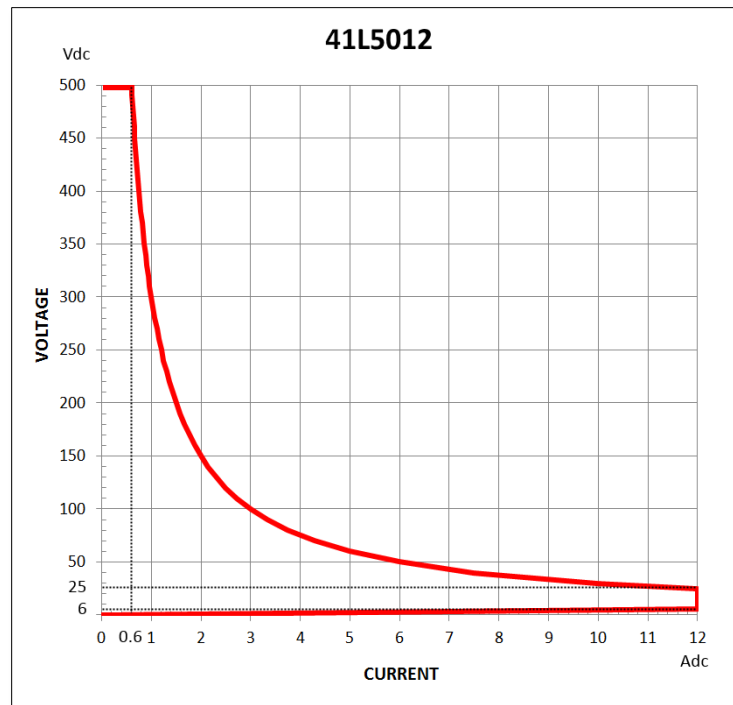

4.10.5 Model 41L0615 V-I Curves

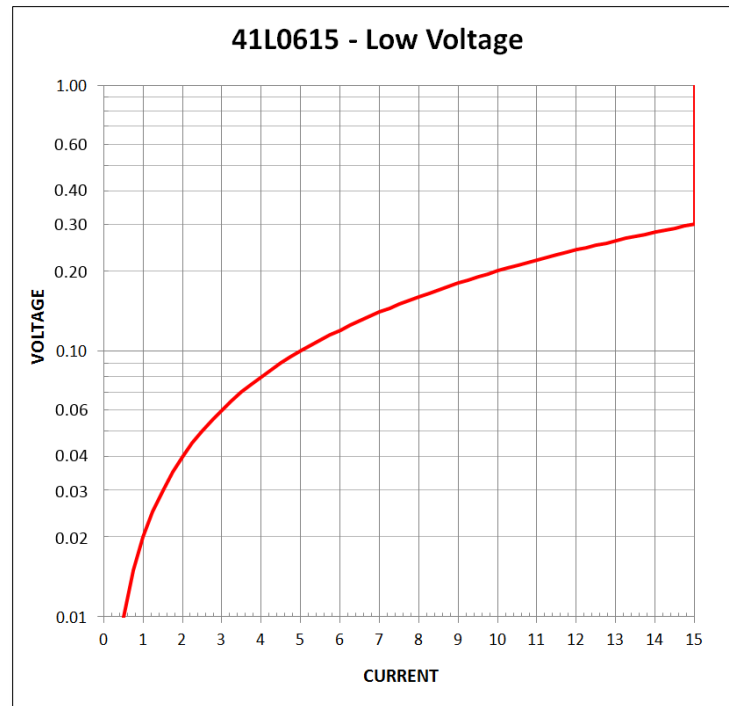
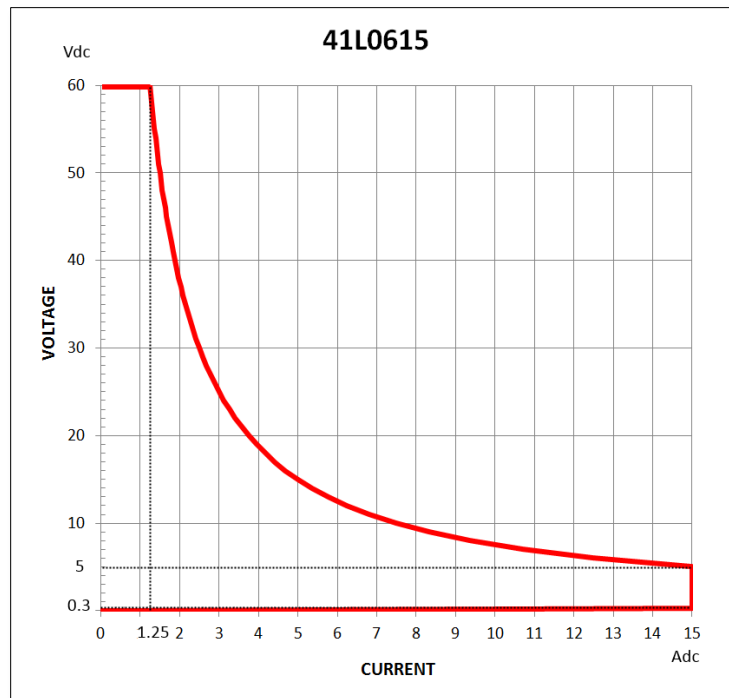



## 5 Unpacking and Installation

### 5.1 Inspection

The 41L Series DC loads are carefully inspected before shipment. If instrument damage has occurred during transport, please inform Adaptive Power Systems' nearest sales and service office or representative.

### 5.2 Load Module Installation and Removal in Mainframe

The 41L Series load modules must be installed in a suitable 44MOX mainframe chassis to be used. The mainframe provides all required bias supply voltages as well as force air cooling of the load module(s).

If ordered at the same time as a 44MOX mainframe, the load modules on the same purchase order will be shipped already installed from the factory. If a load module requires installation or removal in the field, the end user can perform this task easily using the steps below.

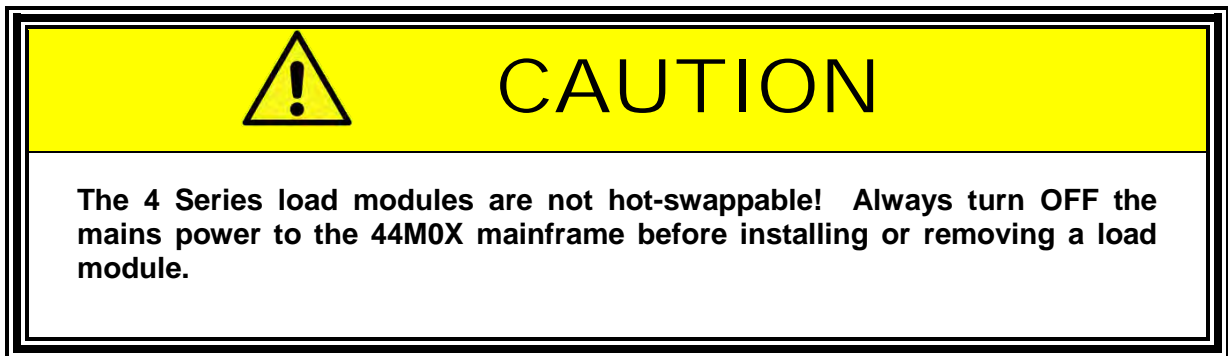

#### 5.2.1 Module Removal

1. First, ensure AC power to the 44MOX mainframe is switched **OFF**. Failure to do so may result in damage to the load module. The load modules are NOT hot-swappable.
2. Loosen and completely remove the Phillips screw in the lower right hand corner of the load modules front panel. This screw prevents the load module from sliding out of its slot position.
3. Once the screw is removed, the handle can be pulled forward to level the module out of its back plane connectors.
4. Once the level has been pulled as far as it will go, the module can be slid out carefully by pulling it forward until it completely clears the mainframe front bezel.

Refer to Figure 5-3 on next page for an illustration.

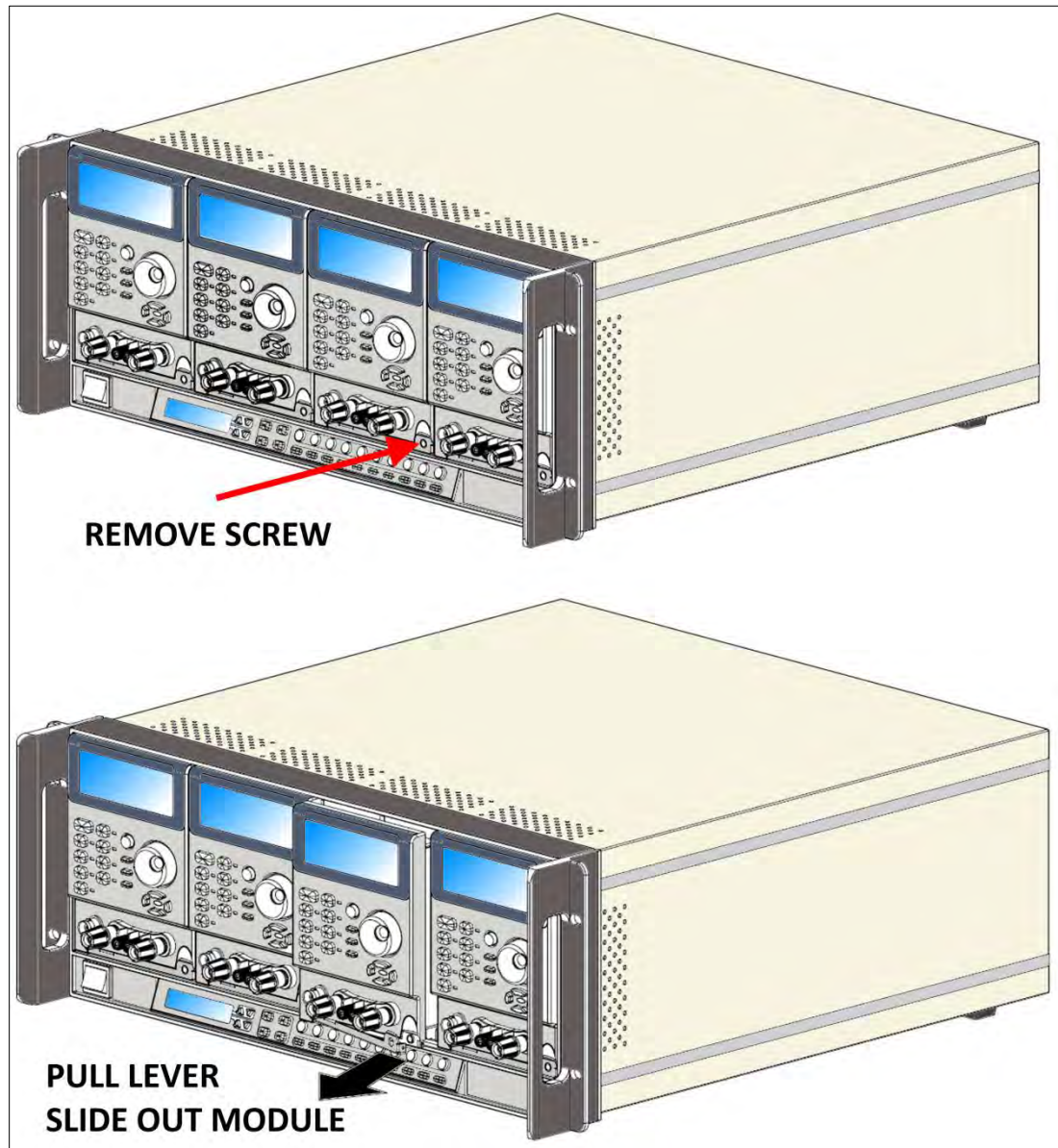



Figure 5-1: Load Module Removal

### 5.2.2 Module Installation

To install a new or different module in an available slot, follow the removal procedure in reverse order.

### 5.3 Cleaning

To clean this product uses a soft or slightly damp cloth.

CAUTION

**BEFORE you clean the unit, switch the mains power off and disconnect the input line cord.**

- **Please do NOT use any organic solvent capable of changing the nature of the plastic such as benzene or acetone.**
- **Please ensure that no liquid is allowed to penetrate this product.**

### 5.4 Powering Up

The following procedure should be followed before applying mains power:

1. Check that the POWER switch is in the OFF (O) position.
2. Verify that the rear panel voltage selector of the chassis is correctly set.
3. Check that nothing is connected to any of the DC INPUT (load input terminals) on the front and/or rear panels.
4. Connect the correct AC mains line cord to the 41L Series load AC input terminal.
5. Plug the line cord plug into a suitable AC outlet socket.
6. Turn on (I) the POWER switch.
7. If the instrument does not turn on for some reason, turn OFF the POWER switch and verify the presence of the correct AC line input voltage using appropriate safety measures.

### 5.5 In Case of Malfunction

In the unlikely event of an instrument malfunction or if the instrument does not turn on despite the presence of the correct AC line voltage, please attach a warning tag to the instrument to identify the owner and indicate that service or repair is required. Contact Adaptive Power Systems or its authorized representative to arrange for service.

## 5.6 Load Connections

When setting up for a new test and connecting any equipment to the DC load, proceed as follows:

1. Always make sure the DC load is turned OFF at the POWER switch when making any wire connections.
2. Check that the output of the equipment under test is **OFF**.  
**Note:** Some power equipment's output may still be energized even if the equipment has been turned off or its output is turned off. This is especially true for DC power supplies.

**Note:** When working with batteries, it is recommended to provide a suitable disconnect relay or switch so the load connection can be disconnected from the battery for handling purposes.

3. Connect one end of the load wires to the load input terminals on the rear panel.
4. Check the polarity of the connections and connect the other end of the load wires to the output terminal of the equipment under test.
5. When connecting multiple loads to the same EUT, make sure the load wire lengths to each load are the same.

## 5.7 Analog Programming Input

The 41L Series has an analog programming input located on the rear panel of the 44M0X mainframe. This feature allows an external waveform to be tracked as long as it is within the load's dynamic capabilities. These inputs will accept a 0-10V signal. This signal is proportional to the load's maximum current range.

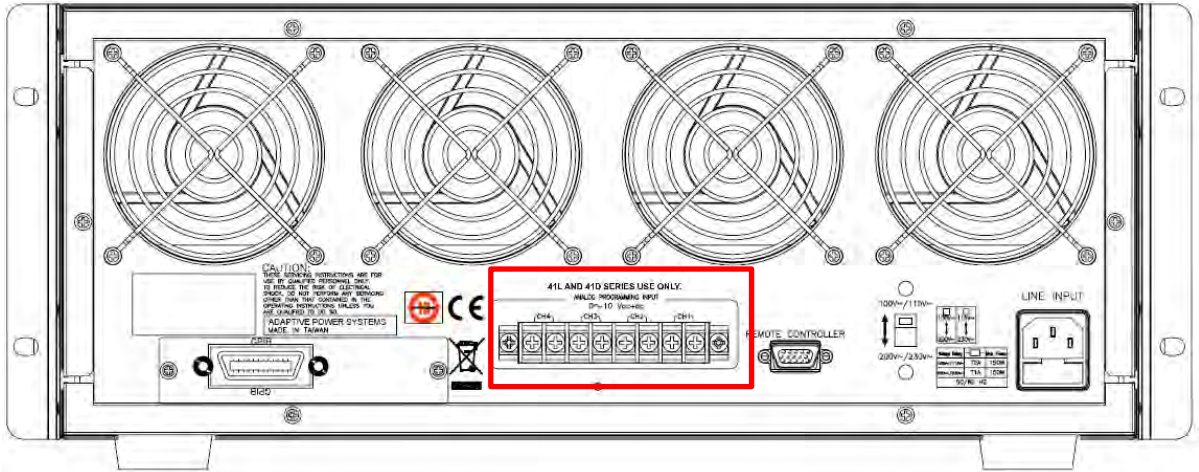

Figure 5-2: Location and Pin-out of Analog Programming Input Connector

Channel positions are numbered from left to right when facing the front of the mainframe as shown in the illustration below.

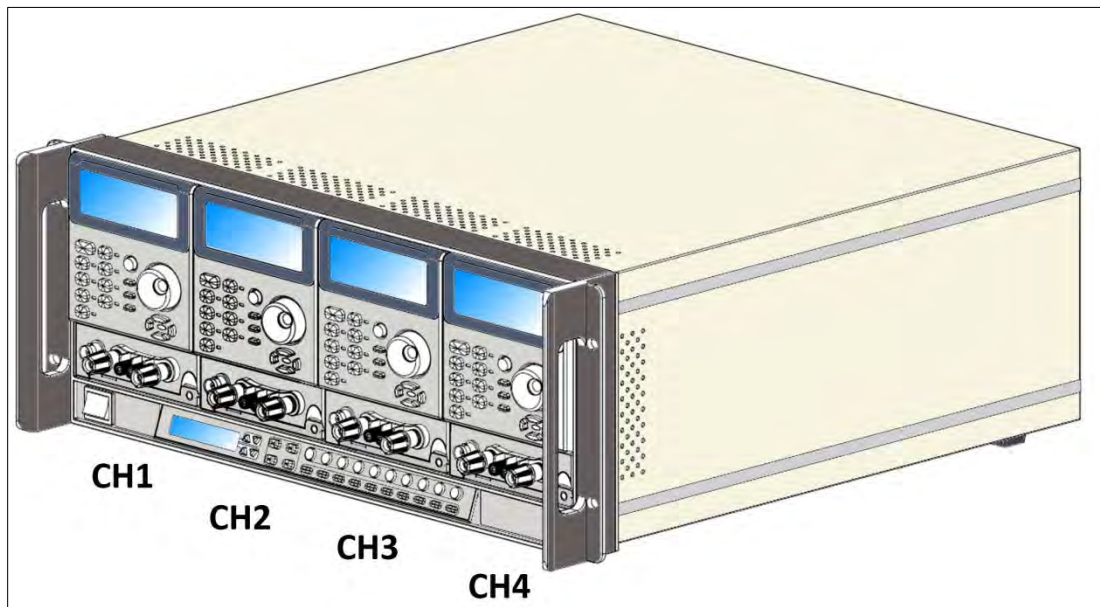

Figure 5-3: Channel Positions for Analog Input Identification



The analog programming input operates in CC or CP modes only. The load module will attempt to load proportionally according to the signal and the load module's maximum current or power range.

For example:  $I_{max} = 60A$  and  $P_{max} = 300W$

- In CC mode, if the analog programming input is 5V, the load current will be  $0.5 \times 60 = 30A$ .
- In CP mode, if the analog programming input is 1V, the load power setting will be  $0.1 \times 300 = 30W$ .

The analog programming signal can act alone or it can be summed with the programmed value set via the front panel or the optional computer interface (GPIB, RS232, USB, or LAN).

Figure 5-8 shows the result of an analog programming signal at 4Vpp, 500Hz when it is summed with a 24A programmed setting in CC mode of DC load.

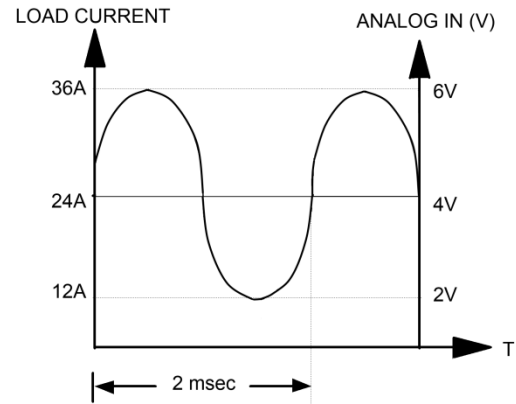

Figure 5-4: Analog Programming Example

## 5.8 Load Current Slew Rate

The programmable current slew rate of the DC load allows control over the rate of change in current any time a change in current occurs. This controls the load current slew rate during load current level changes, power supply turn ON/OFF events or when turning the LOAD ON, and OFF. The 41L Series loads provide controlled current slewing under all of these conditions. The rise and fall current slew rate can each be set independently.

Rise and fall slew rates can be independently programmed. This allows an independent controlled transition from Low load current level to High load current level ( Rise current slew rate ) or from High load current level to Low load current level( Fall current slew rate ) to minimize induced voltage drops on the wiring inductance, or to control induced voltage transients on the device under test ( power supply transient response testing ).

See under "DYNAMIC OPERATION, Slew Rate" in the specification section on page 24 for slew rate programming range by model.

This controllable load current slew rate feature also can eliminate the overload current phenomenon and emulate the actual load current slew rate at turn ON of the power supply under test. Figure 5-9 shows the load current slew rate is according to the power supply's output voltage, load level setting and Load ON/OFF switch.

The ability to apply all these dynamic current characteristics at the same time using the Constant Current mode of the 41L Series load greatly speeds up power supply testing tasks. This can significantly improve the test quality, thoroughness and efficiency.

There are two load current ranges in 41L Series Load, Range I and Range II, the rise and fall slews rate range for both current ranges is specified in Section 4.1, "Technical Specifications" on page 24.

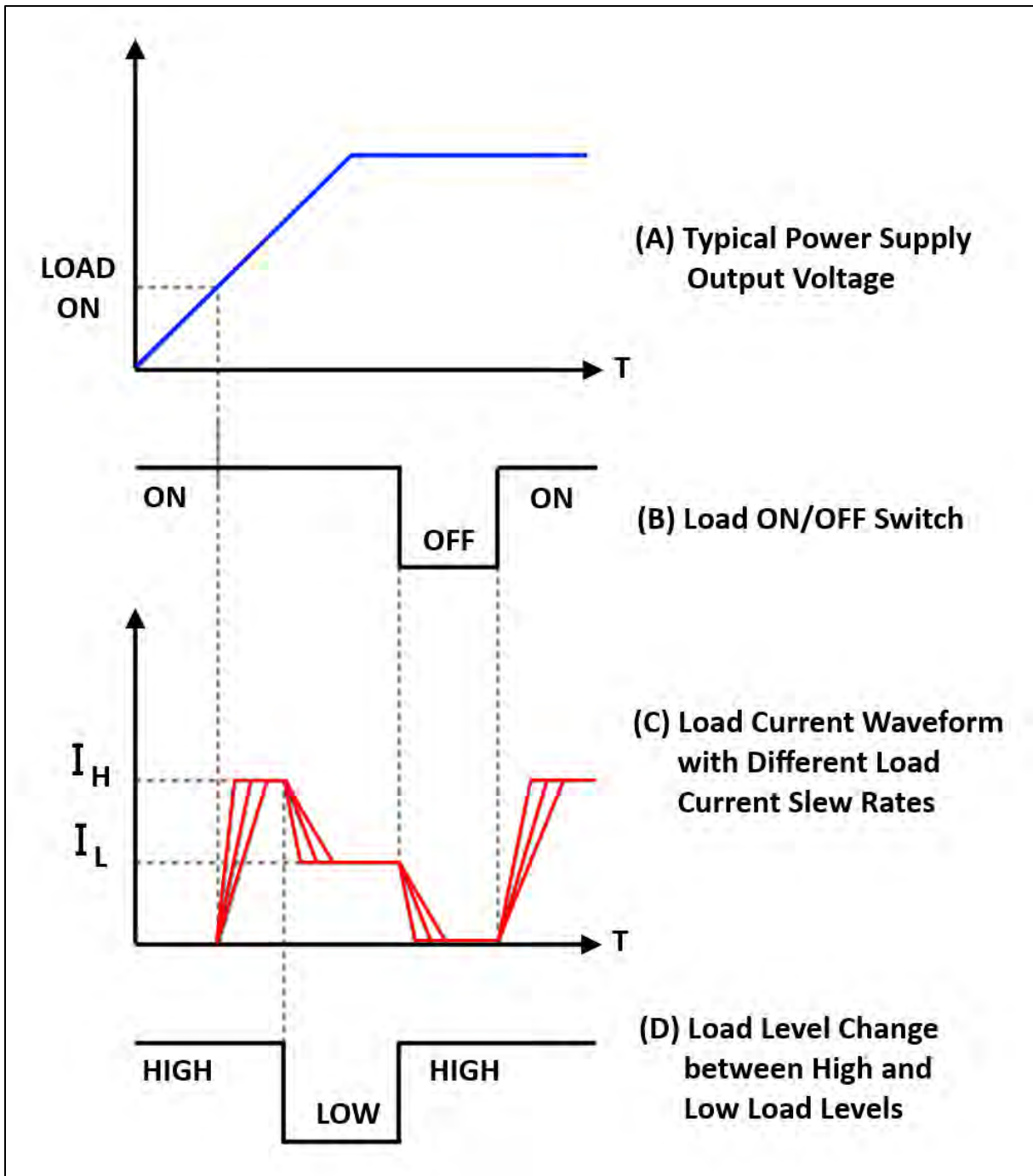

Figure 5-5: Effect of Current Slew Rate Settings on Power Supply Testing

## 6 Front Panel Operation

This Chapter provides an overview of front panel operation for the 41L Series DC Loads. For remote control operation, refer to Section 8 “Remote Control Programming” of this manual for an overview of available programming commands.

### 6.1 Front Panel Layout

The front panel layout is shown in Figure 6-1 below. Rack handles and ears are shown but can be removed if the unit will only be used on the bench.

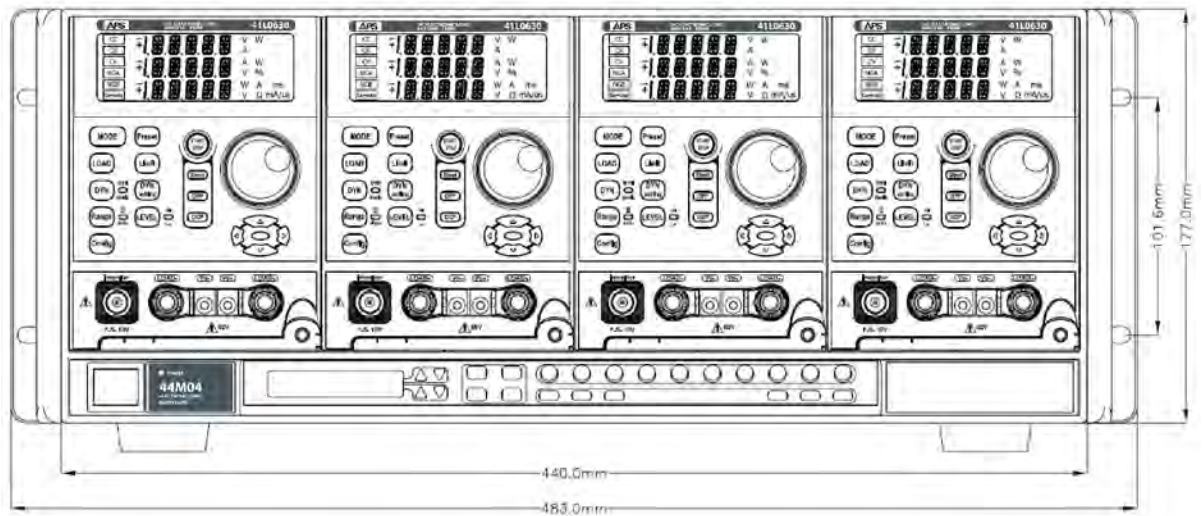

Figure 6-1: 44M04 Chassis with 41L0630 Series Loads Front Panel View

Each load module has its own dedicated LCD readouts located along the top. User controls are located below these displays. Along the bottom edge of the 44M04 chassis, memory bank controls are positioned next to a separate memory bank and system setting display. The power ON/OFF switch is found in the lower left corner.



## 6.2 User Controls and Readouts

The following user controls, indicator and displays are common to all 41L Series load models. The purpose and function of each control and indicator is explained in the table below. Refer to figure for the location of each control and indicator.

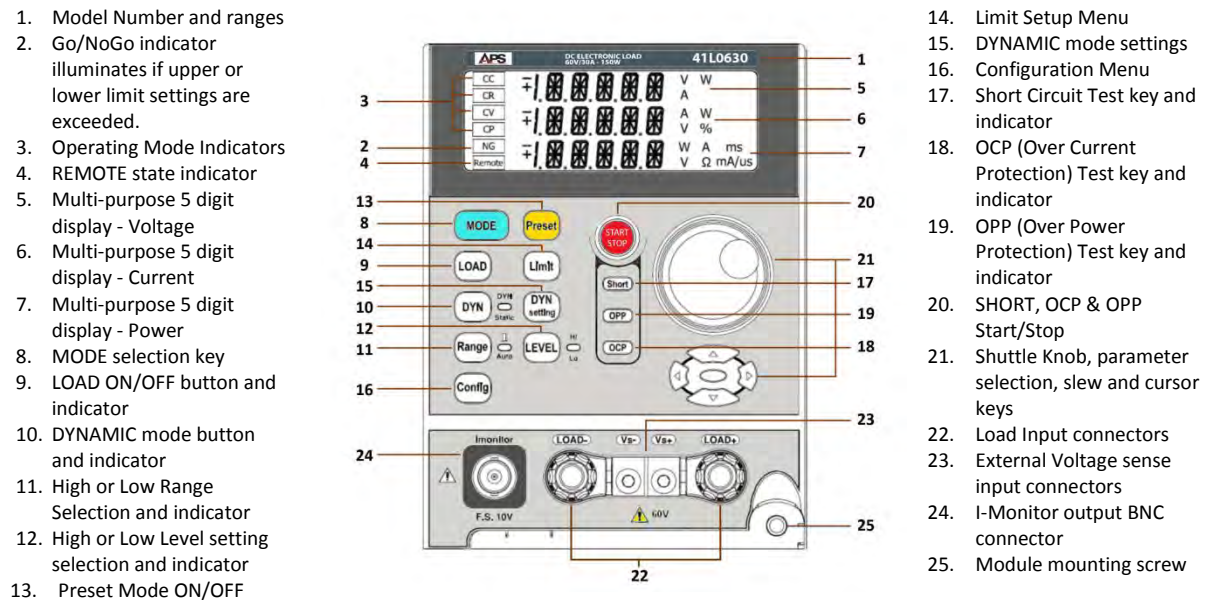

Figure 6-2: Front Panel User Controls and Indicators

The various controls and indicators are explained in more detail in the table below. The Item numbers correspond to the indices in Figure above.

| KEY# | Description  |
|------|--|
| 1    | Indicates the <b>model number</b> and key performance specifications of the load.  |
| 2    | <b>Go/NoGo</b> indicator illuminates if upper or lower limit settings are exceeded.  |
| 3    | There are four operating modes can be selected by pressing the "MODE" key on the electronic load. The sequence is Constant Current ( CC ), Constant Resistance ( CR ), Constant Voltage ( CV ), Constant Power ( CP ) and then repeats. When pressing the "MODE" key, the CC, CR, CV, CP mode indicator will be lit respectively when the appropriate operating mode is selected.<br><br>The operating theorem of CC, CR, CV and CP mode is described in Section 3.2, "Operating Modes".<br><br>There are two programming ranges in CC, CR, CV and CP mode respectively; the 41L Series load can adjust to the optimal range automatically according to the programmed load level. The range selection criteria are described below for each operating mode. |

| KEY#     | Description  |
|----------|--|
|          | <p><b>CC Mode</b></p> <p>The Range I (6A) indicates low load current operating range; Range II (60A) indicates high load current operating range. The specification of load current ranges is listed in Section 4.1. The current range is changed automatically in accordance to the programmed load current.</p> <p>Range I is selected automatically if the programmed load current is less than the maximum current of Range I, and will be set to Range II automatically when the programmed current is higher than the maximum current of Range I.</p>  |
|          | <p><b>CR Mode</b></p> <p>Range I indicates low load resistance operating range, Range II indicates high load resistance operating range. The specification of the resistance ranges is shown in section 4.1, "Operating Ranges". The resistance range is changed automatically in accordance to the programmed load resistance.</p> <p>The electronic load will switch to Range I automatically if the programmed load resistance is higher than the minimum load resistance of Range I, and will be set to Range II when the programmed load resistance is lower than the minimum load resistance of Range I.</p> |
|          | <p><b>CV Mode</b></p> <p>Range I indicates low load voltage operating range, Range II indicates high load voltage operating range. The specification of voltage ranges is shown in section 4.1, "Operating Ranges". The voltage range is changed automatically in accordance to the programmed load voltage.</p> <p>Range I is selected automatically if the programmed load voltage is less than the maximum voltage of Range I (6V), and will be set to range II automatically when the programmed voltage is higher than the maximum voltage of Range I (6V).</p>   |
|          | <p><b>CP Mode</b></p> <p>Range I indicates low load power operating range, Range II indicates high load power operating range. The power range specification is shown in section 4.1, "Operating Ranges". The power range is changed automatically in accordance with the programmed load power.</p> <p>Range I is selected automatically if the programmed load power is less than the maximum power of Range I (120W), and will be set to Range II automatically when the programmed power is higher than the maximum power of Range I (120W).</p>   |
| <b>4</b> | <p>The Remote LCD Indicator is used to indicate the status of remote operation. Front panel operation is locked out while the remote LCD annunciator is ON. In case of Local mode or manual operation, the Remote LCD annunciator is OFF</p>   |

| KEY# | Description  |
|------|--|
| 5    | <p>The 5 digit LCD display is a multi-function display, the functions are described below:</p> <p><b>Normal mode:</b></p> <p>This is a 5 digit DVM display, measuring data of the DC input terminal or V-sense input terminal if V-sense AUTO is programmed. If V-sense ON is programmed, the display shows the voltage at the V-sense input terminal only.</p> <p>When the auto-sense of V-sense function is programmed, the auto-sense circuit of the electronic load can check if the V-sense cable is connected, If the V-sense input detected is greater than 0.7V (e.g. 5L12-24,) or not. If both conditions are true, the 5 digit DVM measures at the sense input (remote V sense); otherwise, the 5 digit DVM measures at the DC input terminals of the load (local V sense).</p> <p><b>Test Setting Mode:</b></p> <p>Short: Short test Enable and Short Setting programming: Display will show: "Short".</p> <p>OPP: OPP test Enable and OPP Setting programming: Display will show: "OPP".</p> <p>OCP: OCP test Enable and OCP Setting programming: Display will show: "OCP".</p> <p>During Short, OCP and OPP test programming, this display will show sensed voltage or load Input voltage.</p>  |
| 6    | <p>This readout can be in one of two modes: Normal or Setting mode.</p> <p>In "Normal" mode, this 5 digit LCD displays the measured current of the DC load when the load is ON.</p> <p>In "Setting" mode, this LCD displays the following setting parameters. The rotary knob is used to scroll through these settings:</p> <ol style="list-style-type: none"> <li>1. Config ON programming: Display will individually show "SENSE", "LDon", "LDoFF", "POLAR", "MPPT" and "AVG".</li> <li>2. Limit ON programming: Display will individually show "V_Hi", "V_Lo", "A_Hi", "A_Lo", "W_Hi", "W_Lo" and "NG".</li> <li>3. DYN setting ON programming: Display will individually show "T-Hi", "T-Lo", "RISE" and "FALL".</li> <li>4. Short setting programming: Display will individually show "TIME", "V-Hi" and "V-Lo".</li> <li>5. OPP setting programming: Display will individually show "PSTAR", "PSTEP", "PSTOP" and "VTH".</li> <li>6. OCP setting programming: Display will individually show "ISTAR", "ISTEP", "ISTOP" and "VTH".</li> </ol> <p>During Short testing: Display shows the actual load current, the unit is "A".</p> <p>During OCP testing: Display shows the actual load current, the unit is "A".</p> <p>During OPP testing: Display shows the actual power, the unit is "W".</p> <p>When over current protect is tripped: Display shows [OCP].</p> |
| 7    | <p>This readout can be in one of two modes: Normal or Setting mode.</p> <p>In "Normal" mode, this 5 digit LCD displays the power dissipated by the DC load when the load is ON.</p>  |

| KEY# | Description  |
|------|--|
|      | <p>In "Setting" mode, this LCD displays the following setting parameters. The rotary knob is used to scroll through these settings:</p> <ol style="list-style-type: none"> <li>1. PRESET ON mode display will individually show:               <ol style="list-style-type: none"> <li>a. CC mode's current programming value display, the unit is "A"</li> <li>b. CR mode's resister programming value display, the unit is "Ω"</li> <li>c. CV mode's voltage programming value display, the unit is "V"</li> <li>d. CP mode's power programming value display, the unit is "W"</li> </ol> </li> <li>2. LIMIT ON mode display will individually show :               <ol style="list-style-type: none"> <li>a. V_Hi (upper limit voltage) &amp; V_Lo (lower limit voltage) value display, the unit is "V"</li> <li>b. A_Hi (upper limit current) &amp; A_Lo (lower limit current) value display, the unit is "A"</li> <li>c. W_Hi (upper limit power) &amp; W_Lo (lower limit power) value display, the unit is "W"</li> <li>d. NG programming display will show [ON] or [OFF]</li> </ol> </li> <li>3. DYN setting ON mode display will individually show :               <ol style="list-style-type: none"> <li>a. T-Hi (level high time)&amp; T-Lo(level low time) programming value display, the unit is "ms"</li> <li>b. Rise/Fall current slew rate programming value display, the unit is "(m)A/us"</li> </ol> </li> <li>4. Config ON mode display will individually show:               <ol style="list-style-type: none"> <li>a. SENSE programming display shows [ON] or [AUTO]</li> <li>b. LDon &amp; LDoff value displayed, the unit are "V"</li> <li>c. Load polarity value display shows [+LOAD] or [-LOAD]</li> </ol> </li> <li>5. Short test Enable, OCP test Enable and OPP test Enable mode will show [START]</li> <li>6. Short Setting mode               <ol style="list-style-type: none"> <li>a. Short setting display will show "CONTI", Short time setting; the unit is "ms"</li> <li>b. V-Hi &amp; V-Lo value display, the unit is "V"</li> </ol> </li> <li>7. OPP Setting mode               <ol style="list-style-type: none"> <li>a. OPP PSTAR, OPP PSTEP and OPP PSTOP value display, the unit is "W"</li> <li>b. OPP Vth value display, the unit is "V".</li> </ol> </li> <li>8. OCP Setting mode               <ol style="list-style-type: none"> <li>a. OCP ISTAR, OCP ISTEP and OCP ISTOP value display, the unit is "A"</li> <li>b. OCP VTH value display, the unit is "V"</li> </ol> </li> </ol> <p>During OCP test &amp; OPP test, display will show [RUN]<br/>           When over power protect: Display will show [OPP]<br/>           When over temperature protect: Display will show [OTP]</p> |
| 8    | <p><b>MODE and CC, CR, CV, CP Indicator</b></p> <p>There are four operating modes that can be selected by pressing the "MODE" key. The sequence is Constant Current ( CC ), Constant Resistance ( CR ), Constant Voltage ( CV ), Constant Power ( CP ) and then repeats while pressing the "MODE" key. The CC, CR, CV or CP mode indicator will be lit respectively when the appropriate operating mode is selected.</p>   |

| KEY# | Description  |
|------|--|
| 9    | <p><b>LOAD ON/OFF key and LED</b></p> <p>The load input can be toggled ON/OFF using the front panel's LOAD ON/OFF key. The load current slew rate follows the slew rate setting, so the load current slew rate will change at the programmed Rise/Fall slew rate setting respectively.</p> <p>Turning the LOAD OFF does not affect the programmed settings. The LED is OFF to indicate LOAD OFF status. The LOAD will return to the previously programmed values when the LOAD key is turned to ON again.</p> <p>The Load ON LED indicates the load is ready to sink current from DC input.</p> <ol style="list-style-type: none"> <li>1. Load ON/OFF key: Switches from load ON to load OFF. The fall slew rate is in accordance with the slew rate setting on the front panel.</li> <li>2. DC input voltage: There is a load ON and load OFF voltage control circuit in the electronic load. When the Device under Test turns ON, the output voltage of D.U.T will increase up from 0 to rated output voltage. The electronic load will start to sink current after load voltage is higher than load ON voltage configuration setting (See "Config" key). The programmed load ON voltage for the 41L Series load is from 0.1 to 25V. When the device under test (DUT) turns OFF, the output voltage of DUT will decrease down to 0 volt. The electronic load will stop to sink current after load voltage is lower than load OFF voltage configuration setting (See "Config" key). The programmed load OFF voltage for the load is from 0 Vdc to the load ON voltage value.</li> </ol> |
| 10   | <p><b>DYN / STA key and LED</b></p> <p>This key is available in Constant Current and Constant Power mode only. In Constant Resistance and Constant Voltage mode, this key has no function and the LED is OFF. The load will default to static mode. In Constant Current and Constant Power mode, the Static or Dynamic mode is toggled by this key; the LED will be lit if the load is in Dynamic mode.</p>  |
| 11   | <p><b>RANGE key and LED</b></p> <p>RANGE AUTO / II Key is for range selection. If the Range AUTO LED is OFF, the load will be in Range I or II in accordance with the actual current value. When Range the II, LED is ON, the current programming will be locked on Range II.</p>  |

| KEY# | Description   |
|------|---|
| 12   | <p><b>LEVEL key and LED</b></p> <p>The LEVEL key is used to toggle between the High and Low load setting value. This applies in sttic mode only. In the Dynamic Constant Current mode, the High and Low level are used to define levels of the dynamic waveform.</p> <ol style="list-style-type: none"> <li>In Constant Current mode: The level is initially set to High. LEVEL High / Low has two levels, Low current level setting must be lower than Level High.</li> <li>In Constant Resistance mode: The level is initially set to High. LEVEL High / Low has two levels, Low resistance level setting must be higher than Level High.<br/><b>Note:</b> CR Mode Level High / Low level by current perspectives.</li> <li>In Constant Voltage mode: The level is initially set to High. LEVEL High / Low has two levels, Low voltage level setting must be lower than Level High.<br/><b>Note:</b> CV Mode Level High / Low has "automatic push function.</li> <li>In Constant Power mode: The level is initially set to High. LEVEL High / Low has two levels, Low power level setting must be lower than Level High.</li> </ol> <p><b>Note:</b> Automatic level function: The High level setting must be higher or equal than Low level setting. When High level is equal to Low level, no further adjustment is possible. When the High level equals the Low level, the Automatic level function will adjust the Low level value so the High level value can continue to be adjusted.</p>  |
| 13   | <p><b>PRESET ON/OFF key and LED</b></p> <p>In PRESET OFF state, the load input voltage is shown on the upper 5-digit meter, and load input current is shown on the middle 5-digit meter. The load input power is shown on the lower 5-digit meter. The engineering unit "V", "A" and "W" LCDs will be lit respectively.</p> <p>In Preset ON state, the PRES. LED is ON, the lower 5-digit meter display will be determined by the CC, Dynamic, CR, CV, and CP operating mode.</p> <p>In Preset ON condition, the 5 digit DAM indicates the set load current, which can be from front panel or remote control interface setting.</p> <ol style="list-style-type: none"> <li>In Constant Current mode: The High / Low level load current value can be preset on the lower 5 digit LCD display. The unit is "A" and the "A" will be lit as well.</li> <li>In Dynamic load mode: The Thigh / Tlow parameters value of High / Low load current duration and Rise / Fall setting can be displayed on the lower 5 digit LCD display. The unit is "ms" and the "ms" will be lit as well.</li> <li>In Constant Resistance mode: The High / Low level load resistance value can be preset on the lower 5 digit LCD display. The engineering unit is "Ω" and the "Ω" will be lit as well.</li> <li>In Constant Voltage mode: The High / Low level load voltage value can be preset on the upper 5 digit LCD display. The unit is "V" and the "V" will be lit as well.</li> <li>In Constant Power mode: The High / Low level load power value can be preset on the upper 5 digit LCD display. The unit is "W" and the "W" will be lit as well.</li> </ol> |

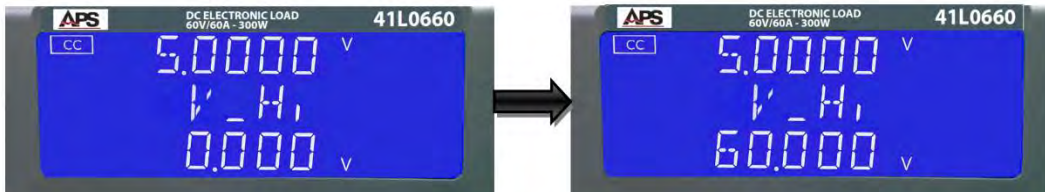
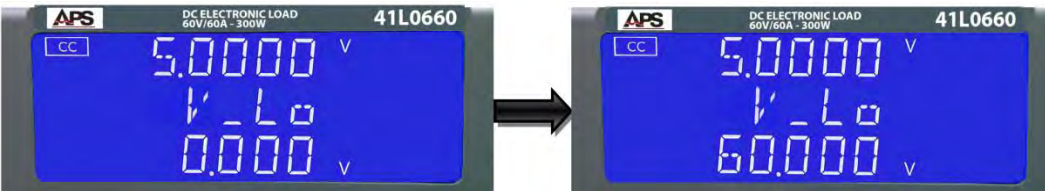
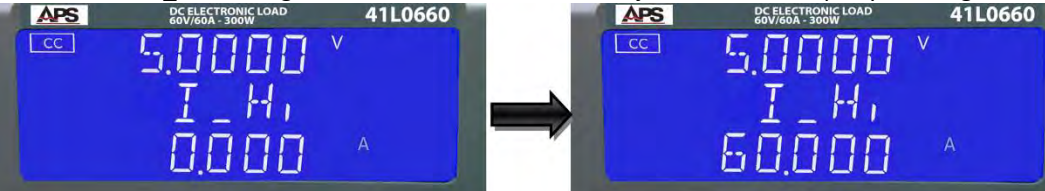
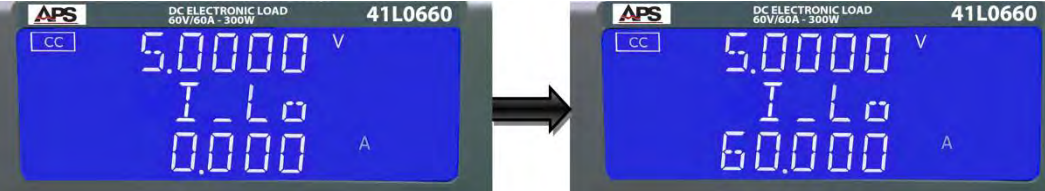
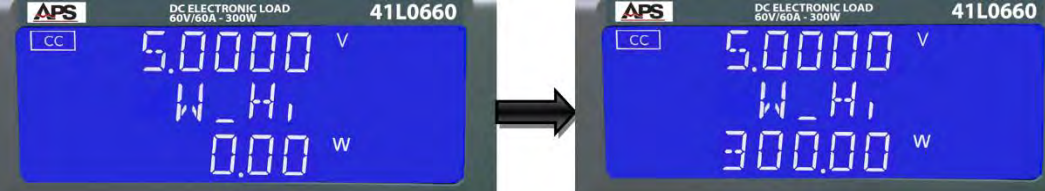

| KEY# | Description   |
|------|---|
| 14   | <p><b>LIMIT key and LED</b></p> <p>The LIMIT key setting includes the GO/NG check of digital voltage meter Upper/Lower limit, current meter Upper/Lower limit, and watt meter Upper/Lower limit within the Limit key setting. The setting sequence is shown below:</p> <p>OFF ⇒ DVM Upper/Lower limit ⇒ DAM Upper/Lower limit ⇒ DWM Upper/Lower limit ⇒ GO/NG check ON/OFF ⇒ OFF ⇒ Repeat</p> <p>The screen images below show the sequence of screens and parameters available to set on each screen. For additional information on using the NG mode, refer to section 6.4, "Go/NoGo LIMIT Testing".</p> |

| KEY# | Description   |
|------|---|
|      | <p><b>Setting Upper limit voltage V<sub>Hi</sub>:</b> Middle 5 digit LCD displays [V<sub>HI</sub>], lower 5 digit LCD displays the unit in "V". The V<sub>Hi</sub> set range is from 0.000V to 60.000V. Adjust in 0.001V steps by rotating the dial.</p>    |
|      | <p><b>Setting lower limit voltage V<sub>Lo</sub>:</b> Middle 5 digit LCD displays [V<sub>LO</sub>], lower 5 digit LCD displays the unit in "V". The V<sub>Lo</sub> set range is from 0.000V to 60.000V. Adjust in 0.001V steps by rotating the dial.</p>    |
|      | <p><b>Setting Upper limit current I<sub>Hi</sub>:</b> Middle 5 digit LCD displays [I<sub>HI</sub>], lower 5 digit LCD displays the unit in "A". The I<sub>Hi</sub> set range is from 0.000A to 60.000A. Adjust in 0.001A steps by rotating the dial.</p>   |
|      | <p><b>Setting lower limit current I<sub>Lo</sub>:</b> Middle 5 digit LCD displays [I<sub>LO</sub>], lower 5 digit LCD displays the unit in "A". The I<sub>Lo</sub> set range is from 0.000A to 60.000A. Adjust in 0.001A steps by rotating the dial.</p>  |
|      | <p><b>Setting Upper limit power W<sub>Hi</sub>:</b> Middle 5 digit LCD displays [W<sub>HI</sub>], lower 5 digit LCD displays the unit in "W". The W<sub>Hi</sub> set range is from 0.00W to 300.00W. Adjust in 0.01W steps by rotating the dial.</p>      |

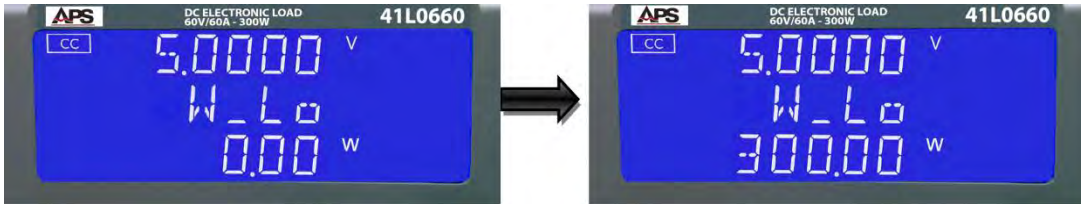
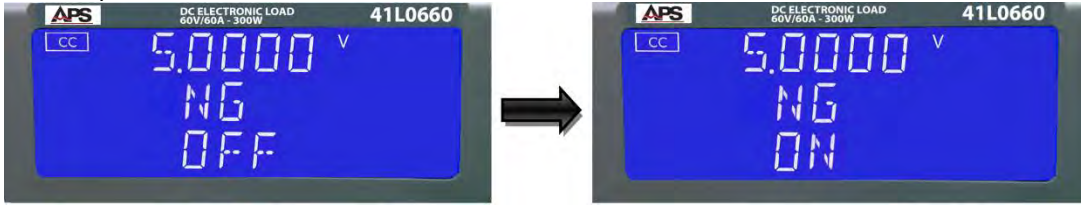

| KEY# | Description  |
|------|--|
|      | <p data-bbox="331 304 1406 394"><b>Setting lower limit power W_Lo:</b> Middle 5 digit LCD displays [W_L0], lower 5 digit LCD displays the unit in "W". The W_Lo set range is from 0.00W to 300.00W. Adjust in 0.01W steps by rotating the dial.</p> <div data-bbox="331 394 1406 596">  </div> <p data-bbox="331 604 1406 661"><b>Setting NG ON/OFF:</b> When NG is turned on (turn dial for ON or OFF), a NG indication will be displayed when any of the set measurement limits is exceeded.</p> <div data-bbox="331 661 1406 863">  </div>  |
| 15   | <p data-bbox="331 877 602 905"><b>DYN setting key and LED</b></p> <p data-bbox="331 919 1349 1010">DYN setting key is to set the Dynamic Mode parameters. They are rise, fall, Thigh and Tlow. Parameters can be changed using the rotary knob. Press any key to escape the DYN parameter setting mode.</p> <ol data-bbox="380 1024 1406 1310" style="list-style-type: none"> <li>1. Press DYN setting key, LED will turn ON</li> <li>2. Setting level High Period: Middle 5 digit LCD display will show "T-Hi", left 5 digit LCD display will show setting value. The unit is "ms"</li> <li>3. Setting level Low period: Middle 5 digit LCD display will show "T-Lo", left 5 digit LCD display will show setting value. The unit is "ms"</li> <li>4. Setting rise time: Middle 5 digit LCD display will show "RISE", left 5 digit LCD display will show setting value. The unit is "(m)A/us"</li> <li>5. Setting fall time: Middle 5 digit LCD display will show "FALL", left 5 digit LCD display will show setting value. The unit is "(m)A/us"</li> </ol> <p data-bbox="331 1325 1406 1415">The screen images below show the sequence of screens and parameters available to set on each screen. For additional information on using the DYNAMIC mode, refer to section 3.3, "Static versus Dynamic Operating Modes".</p> |

| KEY# | Description  |
|------|--|
|      | <p>The time during which the waveform is high includes the rise time and is set in “ms”. The time during which the waveform is low includes the fall time and is set in “ms”. The RISE and FALL times are set in “mA/μs” or “A/μs”. The actual engineering unit is shown in the bottom right corner of the LCD display.</p>  |
|      | <p><b>To program the Dynamic mode, proceed as follows:</b></p> <p>Press DYN setting key. The DYN LED will turn ON. To set the T_Hi high level period, the middle 5 digit LCD display will show [T- Hi]. The lower 5 digit LCD display will show the set value in “ms”. The T_Hi set range is from 0.050 ms to 9999 ms. Adjust in 0.001ms steps by rotating the dial.</p> |

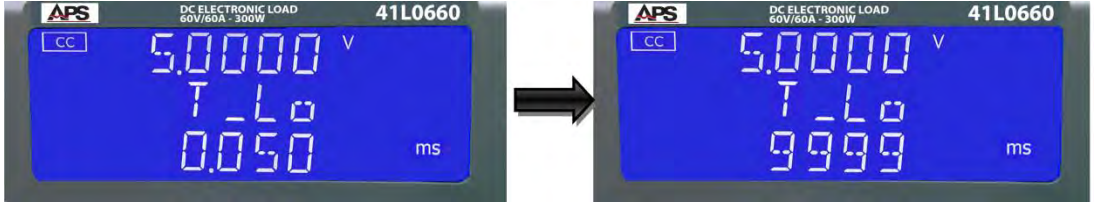
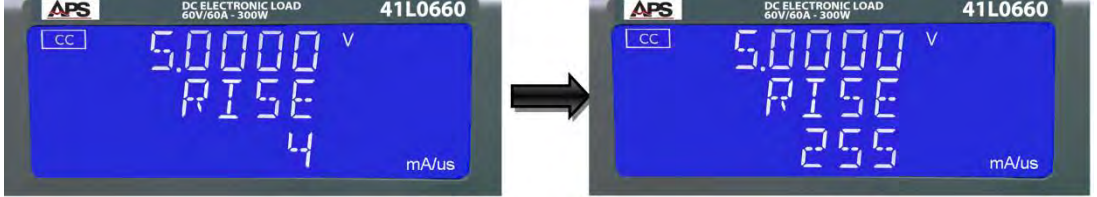
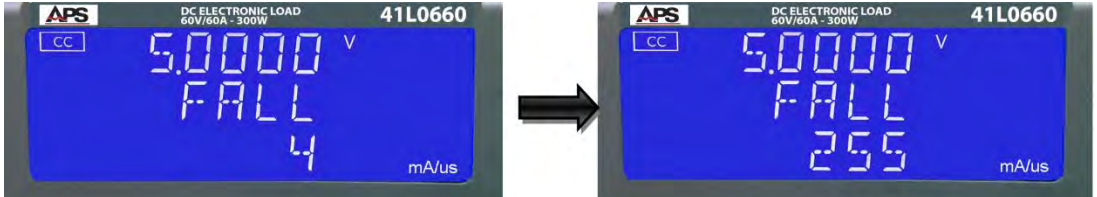
| KEY# | Description  |
|------|--|
|      | <p>To set the T<sub>Lo</sub> high level period, the middle 5 digit LCD display will show [T-L0]. The lower 5 digit LCD display will show the set value in “ms”. The T<sub>Lo</sub> set range is from 0.050 ms to 9999 ms. Adjust in 0.001ms steps by rotating the dial.</p>  |
|      | <p>To set the RISE time, the middle 5 digit LCD display will show [RISE]. The lower 5 digit LCD display will show the current slew rate in “mA/μs”. The slew rate range is from 4mA/μs to 255mA/μs. Adjust in 1mA/μs steps by rotating the dial.</p>                         |
|      | <p>To set the FALL time, the middle 5 digit LCD display will show [FALL]. The lower 5 digit LCD display will show the current slew rate in “mA/μs”. The slew rate range is from 4mA/μs to 255mA/μs. Adjust in 1mA/μs steps by rotating the dial.</p>                       |

| KEY# | Description  |
|------|--|
| 16   | <p><b>CONFIG key and LED</b></p> <p>The CONFIG key setting includes the Sense AUTO/ON, Load ON/OFF voltage, Load Polarity, MPPT tracking and measurement averaging. Each press of the CONFIG key moves the menu one step. On the first press of the CONFIG key, the CONFIG button will illuminate and SENSE will be displayed on the middle LCD. The value is adjusted with the dial and can be read from the lower LCD during setting. The setting sequence is shown below.</p> <p>SENSE AUTO/ON ⇒ Load ON/OFF Voltage ⇒ Polarity setting ⇒ MPPT ⇒ AVG ⇒ Exit</p> <p><b>Notes:</b></p> <ol style="list-style-type: none"> <li>1. The adjustable LOAD ON voltage (LD ON) is valid for CC, CR &amp; CP operating modes only. It does not operate in CV mode.</li> <li>2. The LOAD ON voltage setting cannot be lower than the LOAD OFF voltage setting. If 0V is required for both LOAD ON and LOAD OFF, make the LOAD OFF adjustment first.</li> </ol> |

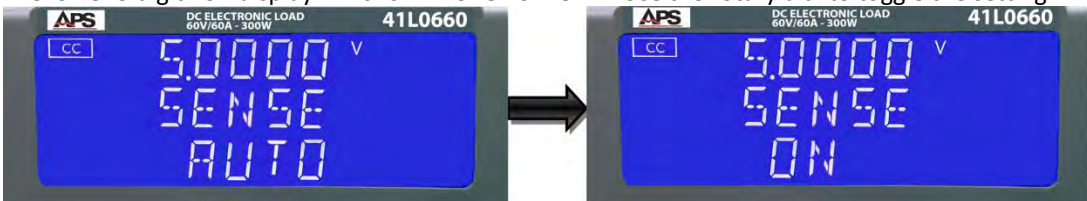
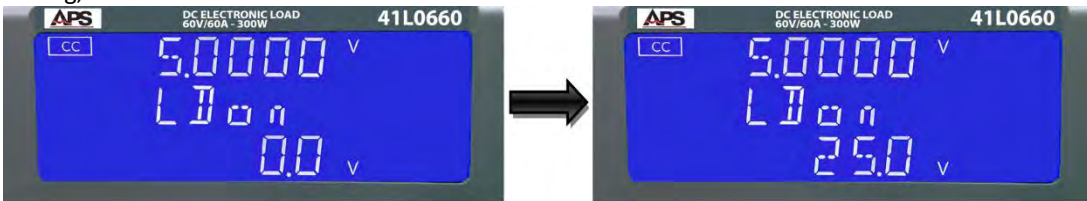
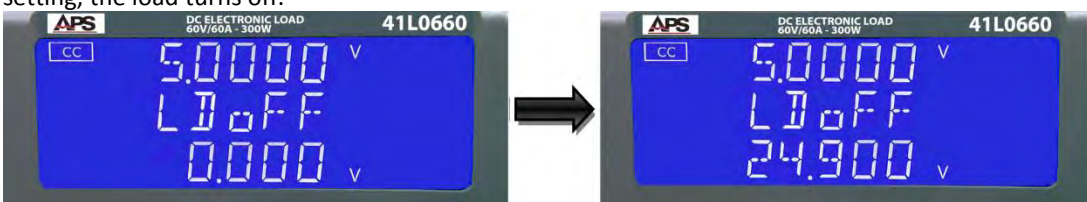
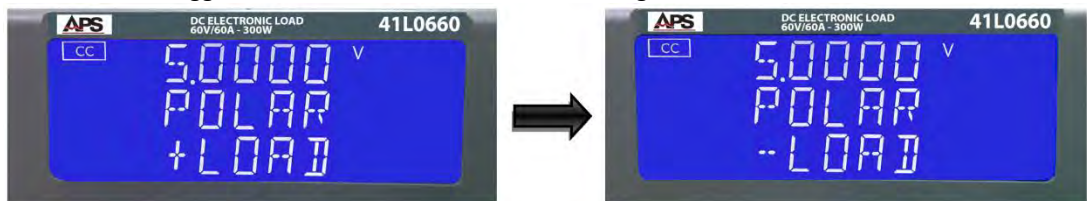

| KEY#                      | Description  |                           |                           |         |                           |         |                           |
|---------------------------|--|---------------------------|---------------------------|---------|---------------------------|---------|---------------------------|
|                           | <p><b>Setting the Vsense mode:</b> Press the CONFIG key. The middle 5 digit LCD display will show "SENSE". The lower 5 digit LCD display will show "AUTO" or "ON". Use the rotary dial to toggle the setting.</p>    |                           |                           |         |                           |         |                           |
|                           | <p><b>Setting the LOAD ON voltage levels:</b> Press the CONFIG key twice. The middle 5 digit LCD display will show "LDon". The lower 5 digit LCD display will show the set value in Volts. The Load ON Voltage set range varies by 41L model:</p> <table border="0"> <tr> <td>41L0615 ,41L0630, 41L0660</td> <td>0V to 25V in 0.1V steps</td> </tr> <tr> <td>41L2512</td> <td>0V to 50V in 0.2V steps</td> </tr> <tr> <td>41L5012</td> <td>0V to 100V in 0.5V steps</td> </tr> </table> <p>Adjust by rotating the dial. If the input voltage to the load is greater than the Load ON voltage setting, the load starts to sink current.</p>                        | 41L0615 ,41L0630, 41L0660 | 0V to 25V in 0.1V steps   | 41L2512 | 0V to 50V in 0.2V steps   | 41L5012 | 0V to 100V in 0.5V steps  |
| 41L0615 ,41L0630, 41L0660 | 0V to 25V in 0.1V steps  |                           |                           |         |                           |         |                           |
| 41L2512                   | 0V to 50V in 0.2V steps  |                           |                           |         |                           |         |                           |
| 41L5012                   | 0V to 100V in 0.5V steps   |                           |                           |         |                           |         |                           |
|                           | <p><b>Setting the LOAD OFF voltage levels:</b> Press the CONFIG key till the LOAD OFF screen appears. The middle 5 digit LCD display will show "LDOFF". The lower 5 digit LCD display will show the set value in Volts. The Load OFF Voltage set range varies by 41L model:</p> <table border="0"> <tr> <td>41L0615 ,41L0630, 41L0660</td> <td>0V to 24.9V in 0.1V steps</td> </tr> <tr> <td>41L2512</td> <td>0V to 49.8V in 0.2V steps</td> </tr> <tr> <td>41L5012</td> <td>0V to 99.5V in 0.5V steps</td> </tr> </table> <p>Adjust by rotating the dial. If the input voltage to the load is lower than the Load OFF voltage setting, the load turns off.</p>  | 41L0615 ,41L0630, 41L0660 | 0V to 24.9V in 0.1V steps | 41L2512 | 0V to 49.8V in 0.2V steps | 41L5012 | 0V to 99.5V in 0.5V steps |
| 41L0615 ,41L0630, 41L0660 | 0V to 24.9V in 0.1V steps  |                           |                           |         |                           |         |                           |
| 41L2512                   | 0V to 49.8V in 0.2V steps  |                           |                           |         |                           |         |                           |
| 41L5012                   | 0V to 99.5V in 0.5V steps  |                           |                           |         |                           |         |                           |
|                           | <p><b>Setting the Load polarity:</b> Press the CONFIG key till the POLARITY screen appears. The middle 5 digit LCD display will show "POLAR". The lower the 5 digit LCD display will show "+ LOAD" or "-LOAD". Use the dial to toggle between "+ LOAD" or "-LOAD" settings.</p>    |                           |                           |         |                           |         |                           |

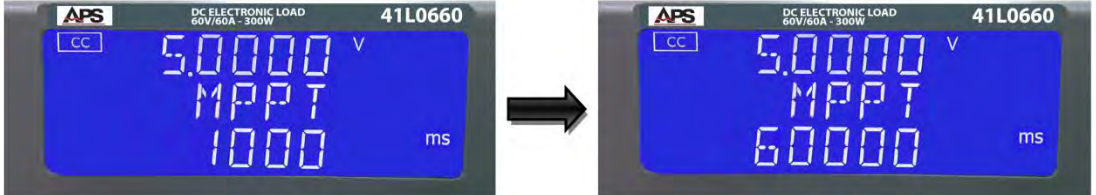
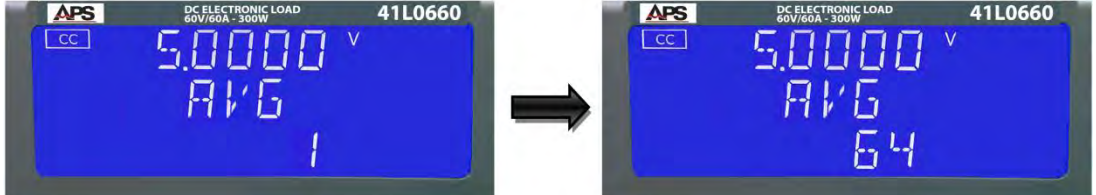



| KEY# | Description   |
|------|---|
|      | <p><b>Setting MPPT time interval:</b> Press the CONFIG key till the MPPT screen appears. The middle 5 digit LCD display will show "MPPT". The lower 5 digit LCD display will show the MPPT interval time in msec. This value is the time between recordings on MPP voltage, current and power to internal memory. The internal memory buffer can hold up to 720 recordings. The MPPT setting range is from 1000ms to 60000ms in 1000ms steps. Adjust by rotating the dial. When the internal buffer is full MPP recording stops automatically. The memory buffer is erased when the load is powered off. For more information on using the MPPT operation mode, refer to section 6.5, "MPPT Mode".</p>  |
|      | <p><b>Note:</b> This function requires firmware revision r1.1 or higher.</p> <p><b>Setting AVERAGING:</b> Press the CONFIG key till the AVERAGE screen appears. The middle 5 digit LCD display will show "AVG". The lower 5 digit LCD display will show the AVERAGING count. The averaging range is from 1 (default) to 64 in 1 increments. Adjust by rotating the dial. Averaging of measurements results in more stable readings but slows down the measurement update rate. If averaging is required, chose a setting that best balances stability of readings with update rate.</p>  <p><b>Note:</b> This function requires firmware revision r2.05 or higher.</p>                                 |

| KEY# | Description   |
|------|---|
| 17   | <p><b>SHORT key and LED Functions</b></p> <ol style="list-style-type: none"> <li>1. Short test function Enable/Disable Key: Press the “SHORT” key to enable the short test function. The indicator LED will be lit. The LCD display shows “SHORT” on the upper 5-digit LCD display, shows “PRESS” on the middle 5-digit LCD display and shows START” on the lower 5-digit LCD display.</li> <li>2. Short test function parameter setting key: There are three parameters for the SHORT test function. The parameters are: TIME, V-Hi and V-Lo. Press the “SHORT” key again to set short test time when the SHORT test function is enabled. Press SHORT key again to proceed to the next parameter and follow the sequence of TIME, V-Hi, V-Lo and Disable. Press any another key to exit and save the SHORT settings. The SHORT test parameter descriptions are as follows:               <ol style="list-style-type: none"> <li>a. TIME: Setting the short test time. The LCD display shows “SHORT”, “TIME” and CONT (or initial setup value) on the top to bottom 5-digit LCD displays. The setting range is “CONTI” which means continuous or 100ms to 10000ms in 100ms steps. Turn the rotary knob clockwise to adjust this the setting. The short test will have no time limitation when set to “CONTI” until the “START/STOP” key is pressed to stop the short test.</li> <li>b. V-Hi: Short test voltage check upper limitation setting. The LCD displays show “SHORT”, “V-Hi” and 0.00V (or initial setup value) from top to bottom. The V-Hi setting range is from 0.00 to 60.00V in 0.01V steps and can be adjusted by turning the rotary knob.</li> <li>c. V-Lo: Short test voltage check lower limitation setting. The LCD displays show “SHORT”, “V-Lo” and 0.00V (or initial setup value) from top to bottom. The V-Lo setting range is from 0.00 to 60.00V in 0.01V steps and can be adjusted by turning the rotary knob.</li> </ol> <p><b>Note:</b> The V-Hi and V-Lo parameters of the SHORT test are different from the V-Hi and V-Lo settings of the LIMIT function.</p> </li> <li>3. START/STOP Test key. Press the “START/STOP” key to start or stop the SHORT test when SHORT test function is enabled.<br/>               The Load will go to “ON” state automatically when the “START/STOP” key is pressed and start the SHORT test. The Load will go to “OFF” state automatically when the “START/STOP” key is pressed to stop the short test. However, the Load will stay in the “ON” state if the load was “ON” before SHORT test execution.<br/>               The SHORT test function is used to the UUT’s short circuit protection function. The SHORT test will sink the load’s full scale current until the UUT’s voltage drop is between the set V_Hi and V_Lo limits. The lower 5-digit LCD display will shows "PASS", otherwise it will show "FAIL".<br/>               Press any key to return to normal mode LCD display.</li> </ol> |

| KEY# | Description   |
|------|---|
| 18   | <p><b>OCP key and LED Functions</b></p> <ol style="list-style-type: none"> <li>1. OCP test function Enable/Disable Key. Press the “OCP” key to enable the OCP test function and the indicator LED will be lit. The LCD display shows “OCP” on right 5-digit LCD display, shows “PRESS” on the middle 5-digit LCD display and shows “START” on left 5-digit LCD display.</li> <li>2. OCP test function parameter settings. There are four parameters for the OCP test function. These parameters are: ISTAR, ISTEP, ISTOP and Vth. Press the “OCP” key again to set the OCP test parameter ISTAR(start current point) Press the “OCP” key again to proceed to the next parameter in order of ISTEP, ISTOP, Vth and Disable. Press any another key to exit the and save the OCP settings. The OCP test parameter descriptions are as follows:             <ol style="list-style-type: none"> <li>a. ISTAR: Setting the start current point. The LCD display shows “OCP”, “ISTAR” and 0.000A (or initial setup value) from top to bottom on the 5-digit LCD displays. The setting range is 0.000A to the full scale of the CC mode specification. This parameter can be adjusted by turning the rotary knob.</li> <li>b. ISTEP: Setting the increment current step size. The LCD display shows “OCP”, “ISTEP” and 0.000A (or initial setup value) from top to bottom on the 5-digit LCD displays. The setting range is 0.000A to the full scale of the CC mode specification. This parameter can be adjusted by turning the rotary knob.</li> <li>c. ISTOP: Setting the stop current point. The LCD display shows “OCP”, “ISTOP” and 120.0A (actual value depends on 41L Series model) from top to bottom on the 5-digit LCD displays. The setting range is 0.000A to the full scale of the CC mode specification. This parameter can be adjusted by turning the rotary knob.</li> <li>d. Vth: Setting the threshold voltage. The LCD display shows “OCP”, “Vth” and 0.50V (or initial setup value) from top to bottom on the 5-digit LCD displays. The setting range is 0.00V to the full scale of the Voltage specification. This parameter can be adjusted by turning the rotary knob.</li> </ol> </li> <li>3. START/STOP Test key. Press START/STOP key to start or stop the OCP when the OCP test function is enabled.<br/>             The Load will go to the “ON” state automatically when the “START/STOP” key is pressed and start the OCP test. The load will return to the “OFF” state automatically when the “START/STOP” key is pressed to stop the OCP test. The load will remain in the “ON” state if the load was “ON” before OCP test execution.<br/>             The OCP test function tests the UUT’s over current protection function. The OCP test will start sinking current from I-START and increase by ISTEP current until the UUT’s output voltage drops below the threshold voltage(V-th setting), and the OCP trip point is between the A_Hi and A_Lo limit settings. The lower 5- digits LCD display will shows "PASS", otherwise it will show "FAIL".<br/>             Press any key to return to normal mode LCD display.</li> </ol> |

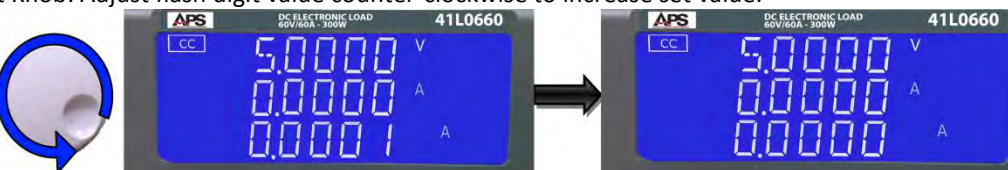

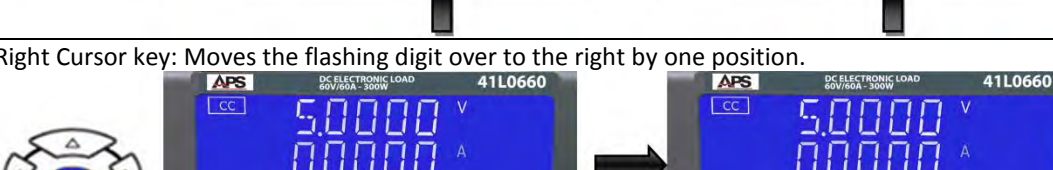
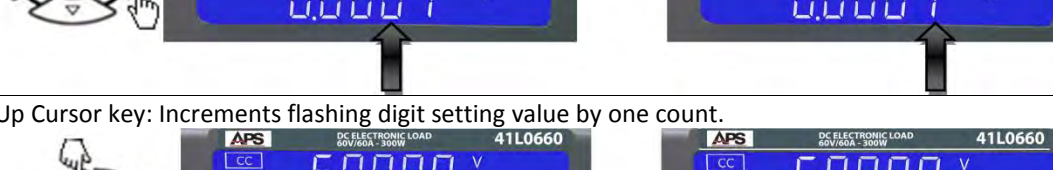
| KEY# | Description   |
|------|---|
| 19   | <p><b>OPP key and LED Functions</b></p> <ol style="list-style-type: none"> <li>1. OPP test function Enable/Disable Key. Press the “OPP” key to enable the OPP test function and the indicator LED will be lit. The LCD display show “OPP” on right 5 left LCD display, shows “PRESS” on middle 5-digit LCD display and shows “START” on the lower 5-digit LCD display.</li> <li>2. OPP test function parameter setting key. There are four parameters for the OPP test function. These parameters are: PSTAR, PSTEP, PSTOP and Vth. Press the “OPP” key again to set the OPP test parameter PSTAR (start power point). Press the “OPP” key again to proceed to the next parameter in order of PSTEP, PSTOP, Vth and Disable. Press any other key to exit and save the OPP setting. The OPP test parameter descriptions are as follows:               <ol style="list-style-type: none"> <li>a. PSTAR: setting the start power, The LCD display shows “OPP”, “PSTAR” and 0.00W (or initial setup value) from top to bottom 5 digits LCD display, the setting range is 0.00W to the full scale of the CP mode specification. The setting is by rotating the dial.</li> <li>b. STEP: setting the increment step power, The LCD display shows “OPP”, “PSTEP” and 0.00W (or initial setup value) from top to bottom 5 digits LCD display, the setting range is 0.00W to the full scale of the CP mode specification. The setting is by rotating the dial.</li> <li>c. PSTOP: setting the stop power, The LCD display shows “OPP”, “PSTOP” and 1200.0W (or initial setup value) from top to bottom 5 digits LCD display, the setting range is 0.00W to the full scale of the CP mode specification. The setting is by rotating the dial.</li> <li>d. Vth: Setting threshold voltage; The LCD display shows “OPP”, “Vth” and 0.50V (or initial setup value) from top to bottom 5 digits LCD display, the setting range is 0.00V to the full scale of the Voltage specification. The setting is by rotating the dial.</li> </ol> </li> <li>3. START/STOP Test key. Press START/STOP key to start or stop the OPP test when the OPP test function is enabled.<br/>               The load will go to the “ON” state automatically when the “START/STOP” key is pressed and start the OPP test. The load will return to the “OFF” state automatically when the “START/STOP” key is pressed to stop the OPP test. The load will remain in the “ON” state if the load was “ON” before OPP test execution.<br/>               The OPP test function tests the UUT’s over power protection function. The OPP test will start sinking current from PSTART and increase power by PSTEP until the UUT’s output voltage drops below the threshold voltage (V-th setting), and the OPP trip point is between the P_Hi and P_Lo limit settings. The lower 5- digits LCD display will shows "PASS", otherwise it will show "FAIL".<br/>               Press any key to return to normal mode LCD display.</li> </ol> |
| 20   | <p><b>START/STOP key Operation</b></p> <ol style="list-style-type: none"> <li>1. Press START/STOP key to start or stop the short test by SHORT, OCP &amp; OPP test setting parameter when SHORT, OCP &amp; OPP test function is enabled.</li> <li>2. The load will go to “ON” automatically when pressing the “START/STOP” key to start the short test and the load will go to “OFF” automatically when pressing the “START/STOP” key to stop the short test. The load will stay to “ON” if it was “ON” before short test.</li> <li>3. The SHORT, OCP &amp; OPP test functions are used to test the circuit protection of a unit under test. These tests will sink the load’s maximum current or power to apply the test condition. If the UUT’s voltage drop is between the V_Hi and V_Lo limits programmed, the lower 5-digit LCD display will shows "PASS", otherwise it will show "FAIL".<br/>               Press any key to return to normal mode LCD display.</li> </ol>   |

| KEY#   | Description  |
|--|--|
| 21   | Rotary Shuttle Knob  |
|  | Right Knob: Adjust flash digit value clockwise to increase set value.  |
|  |    |
|  | Right Knob: Adjust flash digit value counter-clockwise to increase set value.  |
|  |    |
|  | Left Cursor key: Moves the flashing digit over to the left by one position.  |
|  |    |
| Right Cursor key: Moves the flashing digit over to the right by one position.        |  |
|   |  |
| Up Cursor key: Increments flashing digit setting value by one count.                 |  |
|  |  |
| Down Cursor key: Decrements flashing digit setting value by one count.               |  |
|  |  |
| NOTE:  | <ul style="list-style-type: none"> <li>• In CR MODE, the Right and Up Cursor keys decrease setting value.</li> <li>• In CR MODE, the Left and Down Cursors keys increase setting value.</li> </ul> |
| 22   | Load Input Banana Jack connectors. See section 5.6, "Load Connections" for details.  |

| KEY# | Description   |
|------|---|
| 23   | External voltage sense connectors. ( $V_{SENSE}$ ). See section 7.5, "Voltage Sense Input Terminals" for details.     |
| 24   | I-Monitor output BNC connector. See section 7.6, "Current Output Monitor (I-Monitor)" for details.                    |
| 25   | Module installation mounting screw. See section 5.2, "Load Module Installation and Removal in Mainframe" for details. |

*Table 6-1: Front Panel Display and Keyboard Functions*

### 6.3 Operating Flowchart for 41L Series Load Modules

The flow chart on the next page shows the typical load current level and status setting procedures of each load module within a 44M0X mainframe. Load channel numbers 1 to 4 represent modules from left to right in the mainframe respectively. If the mainframe used has fewer than 4 slot positions, skip the corresponding module number.

- The strings shown in the square blocks are programming commands. Please follow the flow chart sequence for optimal and effective load settings.
- The load mode (CC, CR, CV, CP) should be set first. For CR and CV modes, only Static mode is available. For CC and CP modes, both Static and Dynamic modes are available.
- Next, choose high or Low load level and set the load levels for Static mode, or set the six parameters for Dynamic mode.
- The Limit key sets the GO/NG check upper and lower limits for DVM (voltage), DAM (current), and DWM (power) respectively.
- The system configuration settings for V-sense control, Load ON voltage, and load OFF voltage is part of the Limit setting.
- Other keys (Load ON/OFF, Short ON/OFF) can be controlled independently.

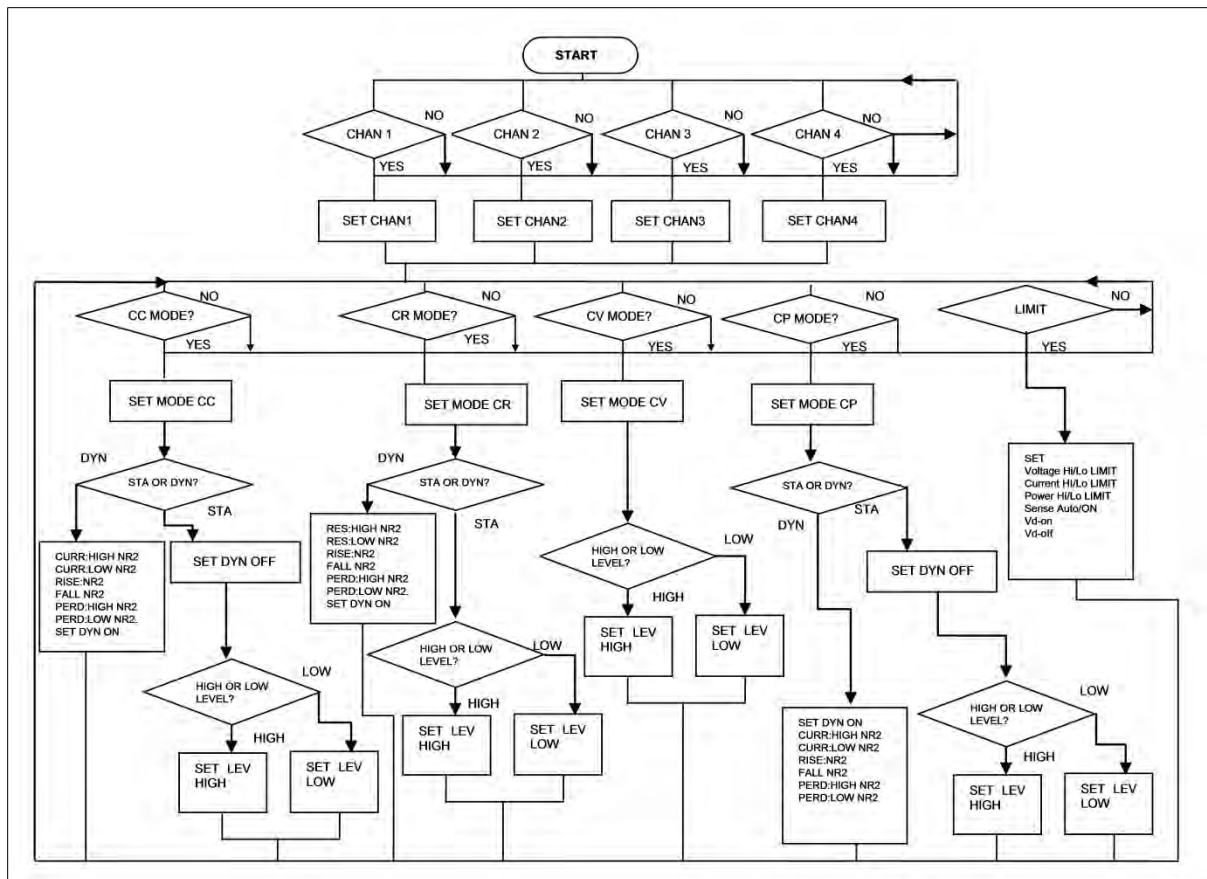

Figure 6-3: Operation Flow Chart - 41L Series Load Module

## 6.4 Go/NoGo LIMIT Testing

The 41L Series load modules have built in Go/NoGo test capability as part of their measurement systems. This allows abnormal conditions to be detected automatically so an EUT can be passed or rejected quickly in a production test environment.

### 6.4.1 Limits

The Go/NoGo is based on comparing measurement data against user provided upper and lower limit settings for voltage, current and power in the LIMIT system.

This creates a GO band (shown in green in the illustrations below) and a NoGo area. If the measurements fall inside the green zone, the test continues with the next step in an auto sequence. If not, a NoGo condition is flagged.

Go/NoGo has different implications depending on the operating mode selected. This is illustrated in the diagrams below.

### 6.4.2 Go/NoGo Testing in CC Mode

In constant current mode, the voltage limits are used to determine the pass or fail area for the input voltage.

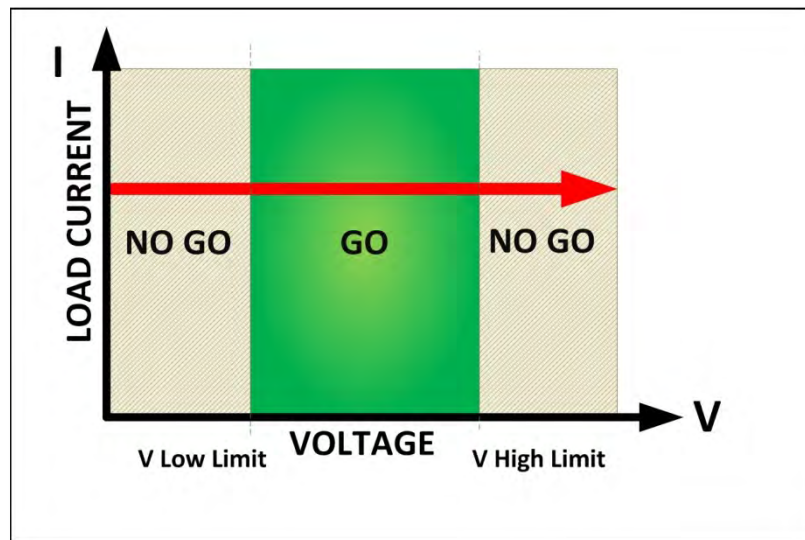

Figure 6-4: LIMIT Test in CC Mode



### 6.4.3 Go/NoGo Testing in CC Dynamic Mode

In dynamic constant current mode, the voltage limits are used to determine the pass or fail area for the input voltage.

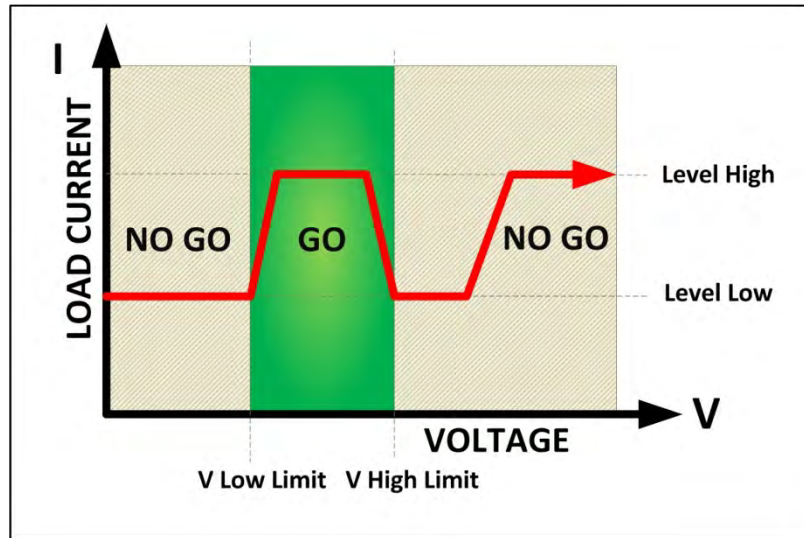

Figure 6-5: LIMIT Test in Dynamic CC Mode

### 6.4.4 Go/NoGo Testing in CR Mode

In constant resistance mode, the voltage limits are used to determine the pass or fail area for the input voltage.

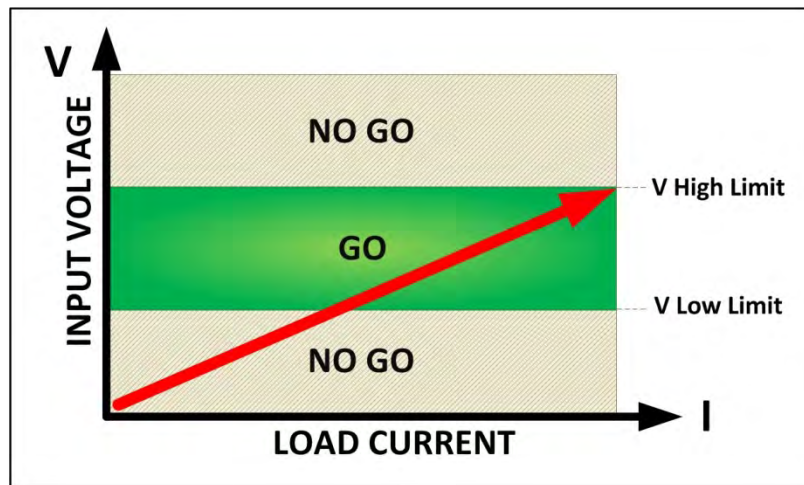

Figure 6-6: LIMIT Test in CR Mode

### 6.4.5 Go/NoGo Testing in CV Mode

In constant voltage mode, the current limits are used to determine the pass or fail area for the load current.

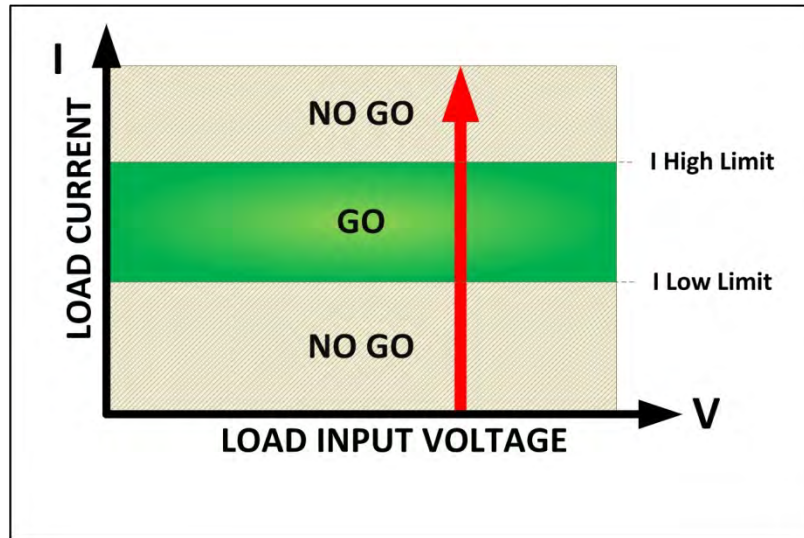

Figure 6-7: LIMIT Test in CV Mode

### 6.4.6 Go/NoGo Testing in CP Mode

In constant power mode, the current limits are used to determine the pass or fail area for the input voltage.

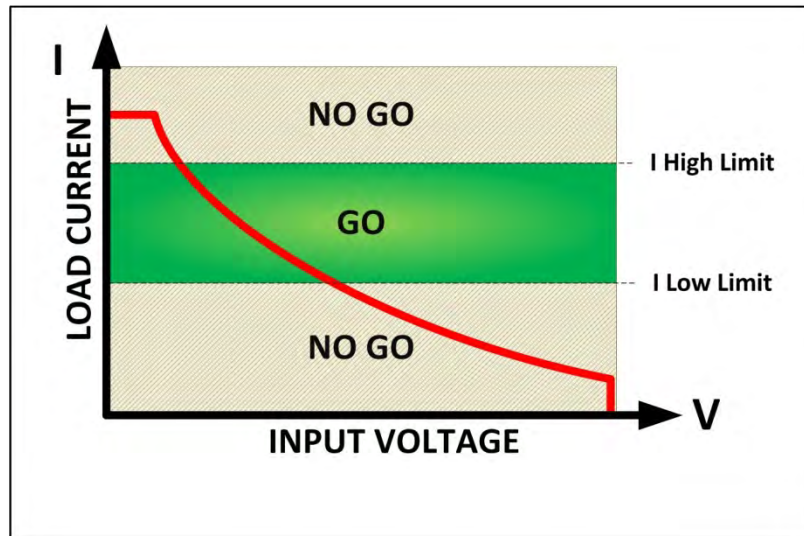

Figure 6-8: LIMIT Test in CP Mode

## 6.5 MPPT Mode

Photovoltaic (PV) devices, such as solar panels and concentrated photovoltaic (CPV) modules, require outdoor testing for design verification, durability, and safety validation. A low cost means of testing the output power of PV devices under real world conditions is to use a DC electronic load capable of supporting the voltage range and power level of the cell or panel.

### 6.5.1 PV Panel Maximum Power Point

One of the key functions of outdoor PV testing is maximum power-point tracking (MPPT). Under any given lighting and temperature condition, there is only one voltage and current combination and thus only one load setting where the power output of the panel is at its highest. As conditions change, the load setting has to change as well to stay on the maximum power point.

But because electronic loads are general-purpose instruments, it is up to the PV test engineer to implement an algorithm in test software that allows the load to adjust itself in order to keep the panel under test at its maximum power point.

Fortunately, there are many MPPT algorithms to choose from, with several published papers on their implementation and performance. However, these algorithms were all designed for solar inverters, not electronic loads. Inverter are not test systems, so a MPPT algorithm that performs well in an inverter may not necessarily perform well as part of a PV test system.

### 6.5.2 DC Load vs Inverter MPPT Algorithms

The main difference between implementing a given MPPT algorithm in an inverter and an electronic load is in the I/O latency. In inverters, the MPPT algorithm runs on an internal microprocessor that can measure, compute and make load adjustments in microseconds. To perform the same set of operations with custom software and an electronic load could easily take tens of milliseconds due to the unavoidable I/O latency between the computer and the load. This I/O latency is a main bottleneck affecting tracking speed. With that in mind, the MPPT algorithm used in the 41L Series loads is specifically designed for test applications.

When testing a PV panel, the electronic load operates in constant voltage (CV) mode. This allows the power to be controlled by increasing or decreasing the amount of current the load draws from the panel. The load will adjust its internal resistance to remain at a set voltage as the current moves along the I-V curve of the panel. If the open circuit voltage of the panel ( $V_{oc}$ ) drops below the load setting voltage, the load will act like an open circuit and the voltage across it will be whatever the  $V_{oc}$  of the panel is.

### 6.5.3 Load MPPT Algorithm

The algorithm used in the 41L Series loads is a modified version of the Perturbation and Observation (P&O) algorithm. The load MPPT algorithm works by making small adjustments in voltage (perturbation) and monitoring the effect on the panel's power output using its current and power measurement system (observation). This information determines if the



panel is at the maximum power point or not and if not, in what direction to move the current to remain at the panel's MPP.

The mathematical relationships of voltage and power that load uses to track the MPP can be expressed as:

- At MPP :  $P_n - P_{n-1} = 0$
- Right of MPP :  $P_n - P_{n-1} > 0$  and  $V_n - V_{n-1} < 0$ ,  $P_n - P_{n-1} \leq 0$  and  $V_n - V_{n-1} \geq 0$
- Left of MPP :  $P_n - P_{n-1} \leq 0$  and  $V_n - V_{n-1} < 0$ ,  $P_n - P_{n-1} > 0$  and  $V_n - V_{n-1} \geq 0$

Where  $P_{n-1}$  is the previous power output and  $P_n$  is the present power output.

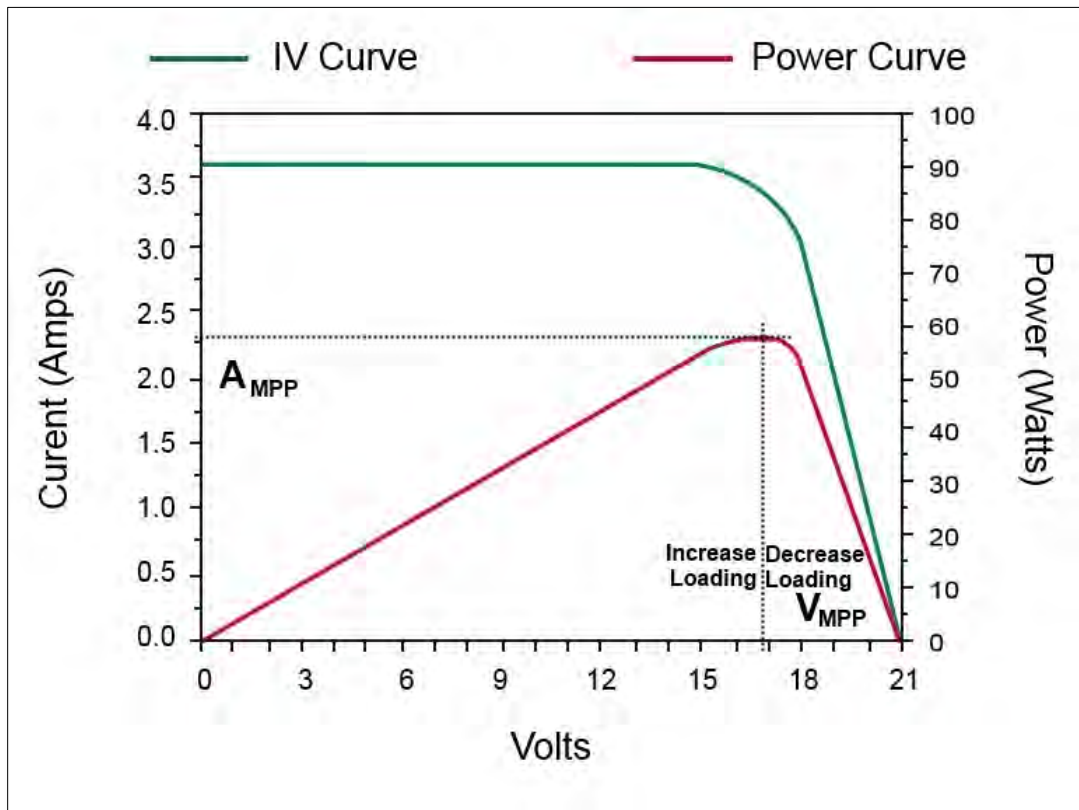

Figure 6-9: MMP Tracking Perturbation and Observation Chart

| $P_n - P_{n-1} > 0$ | $V_n - V_{n-1} > 0$ | Location from MPP | Tracking Load |
|---------------------|---------------------|-------------------|---------------|
| False               | False               | Left              | Decrease      |
| False               | True                | Right             | Increase      |
| True                | False               | Right             | Increase      |
| True                | True                | Left              | Decrease      |

Table 6-2: MMP Tracking Perturbation and Observation Table

#### 6.5.4 Manual MPPT Mode Operation

Press the “CONFIG” key 5 times to select the MPPT function and the initial tracking interval time is 2000mS than press “Start/Stop” key to going to track the MPP( The operation mode will be goes to CV mode and Load ON automatically.)

1. Connecting EUT (PV panel) to load input terminals
2. Press “Config” 5 times to MPPT function
3. Adjust the interval time (default 2000msec) using the dial cursor keys. The interval determines at what interval to record voltage, current and power measurement data in the internal memory buffer of the load. Buffer size is 720 readings sets. MPP tracking will be stop when the buffer is full. The memory will be cleared when power to the load is turned off or a new MPPT test is started.
4. Press Start/Stop to start tracking MPP of UUT
5. The voltage, current and power (MPP) is displayed on the load.
6. Press Start/Stop to stop to tracking the MPP of UUT.

#### 6.5.5 Remote MMPT Programming

1. Send MPPTIME interval time, i.e. MPPTIME 1000.
2. Send command MPPT ON to start tracking MPP of UUT
3. Send MPP? command to read back the voltage, current and power (MPP)
4. Send MPPT OFF to stop tracking the MPP of UUT

## 6.6 Initial Power-on Settings

When powering up the 41L Series electronic loads, the initial load settings after power ON are as shown in the tables below respectively by model number. These are the factory default settings.

### 6.6.1 Model 41L0630 Initial Settings

| Item        |      | Initial value | Item   | Initial value |           |
|-------------|------|---------------|--------|---------------|-----------|
| CC L+Preset |      | 0.000 A       | LIMIT  | V_Hi          | 60.000 V  |
| CC H+Preset |      | 0.000 A       |        | V_Lo          | 0.000 V   |
| CR H+Preset |      | 12000 Ω       |        | I_Hi          | 30.00 A   |
| CR L+Preset |      | 12000 Ω       |        | I_Lo          | 0.0000 A  |
| CV H+Preset |      | 60.000 V      |        | W_Hi          | 150.00 W  |
| CV L+Preset |      | 60.000 V      |        | W_Lo          | 0.000 W   |
| CP L+Preset |      | 0.000 W       | CONFIG | SENSE         | Auto      |
| CP H+Preset |      | 0.000 W       |        | LD-ON         | 1.0 V     |
| DYN         | T HI | 0.050 ms      |        | LD-OFF        | 0.500 V   |
|             | T LO | 0.050 ms      |        | POLAR         | +LOAD     |
|             | RISE | 125.0 mA/μs   |        | MPPT          | 2000 msec |
|             | FALL | 125.0 mA/μs   |        | AVG           | 1         |
|             |      |               |        | SHORT         | Disabled  |
|             |      |               |        | OPP           | Disabled  |
|             |      |               | OCP    | Disabled      |           |

Table 6-3: Model 41L0630 Power-on Settings

### 6.6.2 Model 41L0660 Initial Settings

| Item        |      | Initial value | Item   | Initial value |           |
|-------------|------|---------------|--------|---------------|-----------|
| CC L+Preset |      | 0.000 A       | LIMIT  | V_Hi          | 60.000 V  |
| CC H+Preset |      | 0.000 A       |        | V_Lo          | 0.000 V   |
| CR H+Preset |      | 60000 Ω       |        | I_Hi          | 60.00 A   |
| CR L+Preset |      | 60000 Ω       |        | I_Lo          | 0.0000 A  |
| CV H+Preset |      | 60.000 V      |        | W_Hi          | 300.00 W  |
| CV L+Preset |      | 60.000 V      |        | W_Lo          | 0.00 W    |
| CP L+Preset |      | 0.000 W       | CONFIG | SENSE         | Auto      |
| CP H+Preset |      | 0.000 W       |        | LD-ON         | 1.0 V     |
| DYN         | T HI | 0.050 ms      |        | LD-OFF        | 0.500 V   |
|             | T LO | 0.050 ms      |        | POLAR         | +LOAD     |
|             | RISE | 250.0 mA/μs   |        | MPPT          | 2000 msec |
|             | FALL | 250.0 mA/μs   |        | AVG           | 1         |
|             |      |               |        | SHORT         | Disabled  |
|             |      |               |        | OPP           | Disabled  |
|             |      |               | OCP    | Disabled      |           |

Table 6-4: Model 41L0660 Power-on Settings

### 6.6.3 Model 41L2512 Initial Settings

| Item        |      | Initial value | Item   |          | Initial value |
|-------------|------|---------------|--------|----------|---------------|
| CC L+Preset |      | 0.000 A       | LIMIT  | V_Hi     | 250.00 V      |
| CC H+Preset |      | 0.000 A       |        | V_Lo     | 0.0000 V      |
| CR H+Preset |      | 1500 kΩ       |        | I_Hi     | 12.000 A      |
| CR L+Preset |      | 1500 kΩ       |        | I_Lo     | 0.000 A       |
| CV H+Preset |      | 250.000 V     |        | W_Hi     | 300.00 W      |
| CV L+Preset |      | 250.000 V     |        | W_Lo     | 0.0000 W      |
| CP L+Preset |      | 0.000 W       | CONFIG | SENSE    | Auto          |
| CP H+Preset |      | 0.000 W       |        | LD-ON    | 2.0 V         |
| DYN         | T HI | 0.050 ms      |        | LD-OFF   | 0.500 V       |
|             | T LO | 0.050 ms      |        | POLAR    | +LOAD         |
|             | RISE | 50.0 mA/μs    |        | MPPT     | 2000 msec     |
|             | FALL | 50.0 mA/μs    |        | AVG      | 1             |
|             |      |               | SHORT  | Disabled |               |
|             |      |               | OPP    | Disabled |               |
|             |      |               | OCP    | Disabled |               |

Table 6-5: Model 41L2512 Power-on Settings

### 6.6.4 Model 41L5012 Initial Settings

| Item        |      | Initial value | Item   |          | Initial value |
|-------------|------|---------------|--------|----------|---------------|
| CC L+Preset |      | 0.000 A       | LIMIT  | V_Hi     | 500.00 V      |
| CC H+Preset |      | 0.000 A       |        | V_Lo     | 0.0000 V      |
| CR H+Preset |      | 3000 kΩ       |        | I_Hi     | 12.000 A      |
| CR L+Preset |      | 3000 kΩ       |        | I_Lo     | 0.000 A       |
| CV H+Preset |      | 500.000 V     |        | W_Hi     | 600.00 W      |
| CV L+Preset |      | 500.000 V     |        | W_Lo     | 0.0000 W      |
| CP L+Preset |      | 0.000 W       | CONFIG | SENSE    | Auto          |
| CP H+Preset |      | 0.000 W       |        | LD-ON    | 4.0 V         |
| DYN         | T HI | 0.050 ms      |        | LD-OFF   | 0.500 V       |
|             | T LO | 0.050 ms      |        | POLAR    | +LOAD         |
|             | RISE | 50.0 mA/μs    |        | MPPT     | 2000 msec     |
|             | FALL | 50.0 mA/μs    |        | AVG      | 1             |
|             |      |               | SHORT  | Disabled |               |
|             |      |               | OPP    | Disabled |               |
|             |      |               | OCP    | Disabled |               |

Table 6-6: Model 41L5012 Power-on Settings

6.6.5 Model 41L0615 Initial Settings

| Item        |      | Initial value | Item   |          | Initial value |
|-------------|------|---------------|--------|----------|---------------|
| CC L+Preset |      | 0.000 A       | LIMIT  | V_Hi     | 60.000 V      |
| CC H+Preset |      | 0.000 A       |        | V_Lo     | 0.0000 V      |
| CR H+Preset |      | 240 kΩ        |        | I_Hi     | 15.000 A      |
| CR L+Preset |      | 240 kΩ        |        | I_Lo     | 0.00 A        |
| CV H+Preset |      | 60.000 V      |        | W_Hi     | 75.000 W      |
| CV L+Preset |      | 60.000 V      |        | W_Lo     | 0.0000 W      |
| CP L+Preset |      | 0.000 W       | CONFIG | SENSE    | Auto          |
| CP H+Preset |      | 0.000 W       |        | LD-ON    | 1.0 V         |
| DYN         | T HI | 0.050 ms      |        | LD-OFF   | 0.500 V       |
|             | T LO | 0.050 ms      |        | POLAR    | +LOAD         |
|             | RISE | 62.5 mA/μs    |        | MPPT     | 2000 msec     |
|             | FALL | 62.5 mA/μs    |        | AVG      | 1             |
|             |      |               | SHORT  | Disabled |               |
|             |      |               | OPP    | Disabled |               |
|             |      |               | OCP    | Disabled |               |

Table 6-7: Model 41L0615 Power-on Settings

## 7 Load Connections, Applications and Protection Features

This section covers the following topics:

- Available connectors on the 41L Series load modules
- Connecting the load to various types of equipment
- Internal and External Voltage Sense
- Protection features

### 7.1 INPUT Terminals

The positive and negative terminals for load input connection are located on the lower front panel of the load module.

**Note:** Always refer to Section 2.3 “Safety Information” and Section 2.4 “Safety Notices” before making any load connections.

#### 7.1.1 Banana Jack Connectors

This is the most common way for connecting the equipment to be tested with a 41L series load. It is recommended that this connector be used when the load current is less than 20A as the maximum rated current of the plug connector is 20A. Please avoid exceeding maximum rated current to prevent damage caused by overheating. The maximum supported wire gauge for this connection method is AWG #14.

#### 7.1.2 Y-hook / Spade Lug Terminals

Included in the 41L series load module ship kit is a set of two (2) spade lug-type terminals. These can be used to crimp on to stripped wire ends of an EUT. Hook-type terminals provide good contacting characteristics. It is recommended that the hook-type terminal be used for any occasion where practical. The maximum supported wire gauge of the connection wires for this connection method is AWG #10.

#### 7.1.3 Lead Wire Insertion

This is the simplest way to insert stripped ends of connecting wires into the holes on the metal portion of the input connector jacks. The maximum supported gauge of the connecting wire for this connection method is AWG #14.

#### 7.1.4 Banana Jack Connector and Spade Lug Terminals

This combination method provides a higher current rating and lower impedance of the load connection. When input load currents are higher than 20A or the connecting lead wire is long, this method will be optimal.

### 7.1.5 Plug Connector and Lead Wire Insertion

This method can also be used when the input current is higher than 20A or the connecting lead wire is longer.

## 7.2 Wire Size

A major consideration in making input connection is the wire size. The minimum wire size is required to prevent overheating and to maintain good regulation. It is recommended that the wires are sized large enough to limit the voltage drop at the maximum current rating of the DC load to less than 0.5V per lead.

If needed, wire size can be increased by doubling the number of wires using two space lugs per side as shown in Figure 7-1.

### 7.2.1 Wire Size Guidelines

The following table provides a guide to the current carrying capability (ampacity) of Metric and AWG wire sizes. Metric sizes are expressed as a cross sectional area (CSA) in square millimeters. If in doubt regarding the rating of a cable or wire, consult your cable supplier.

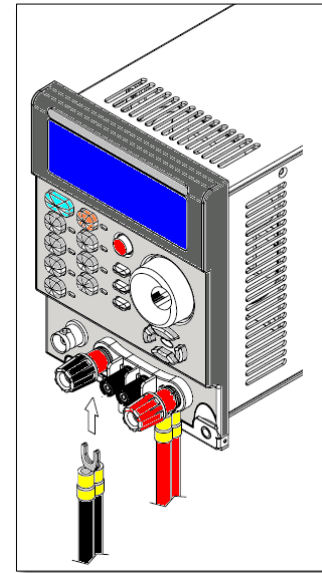

Figure 7-1: Doubling wire size using spade lugs

| Ampacity | AWG Size | CSA (mm <sup>2</sup> ) | Notes   |
|----------|----------|------------------------|---|
| 5.0      | 22       | -                      | Ampacity of aluminum wire is approx. 80% of copper rating   |
| 8.33     | 20       | -                      |   |
| 10       | -        | 0.75                   | When two or more wires are bundled together, ampacity for each wire must be reduced to the following %: |
| 15.4     | 18       | -                      |   |
| 13.5     | -        | 1                      |   |
|          | 16       | -                      | 2 conductors 94%  |
| 16       | -        | 1.5                    | 3 conductors 89%  |
| 31.2     | 14       | -                      | 4 conductors 83%  |
| 25       | -        | 2.5                    | 5 conductors 76%  |
| 40       | 12       | -                      |   |
| 32       | -        | 4                      | Maximum temperatures:   |
| 55       | 10       | -                      | Ambient: 50°C / 122°F   |
| 40       | -        | 6                      | Conductor: 105°C / 221°F  |
| 75       | 8        | -                      |   |
| 63       | -        | 10                     |   |
| 100      | 6        | -                      |   |
| 135      | 4        | -                      |   |

Table 7-1: Load Wire Size Table

**Notes:** AWG ratings are based on MIL-W-5088B, Metric size ratings are based on IEC Publications.

### 7.3 Connecting a UUT

When setting up for a new test and connecting any equipment to the DC load, proceed as follows:

1. Always make sure the DC load is turned OFF at the POWER switch when making any wire connections.
2. Check that the output of the equipment under test is **OFF**.  
**Note:** Some power equipment's output may still be energized even if the equipment has been turned off or its output is turned off. This is especially true for DC power supplies.

Note: When working with batteries, it is recommended to provide a suitable disconnect relay or switch so the load connection can be disconnected from the battery for handling purposes.

3. Connect one end of the load wires to the load input terminals on the rear panel.
4. Check the polarity of the connections and connect the other end of the load wires to the output terminal of the equipment under test.
5. When connecting multiple loads to the same EUT, make sure the load wire lengths to each load are the same.

### 7.4 Polarity and Ground – Multiple Output Power Supplies

- It is recommended to connect the negative DC terminal to ground for positive output power supply EUTs.
- It is recommended to connect the positive DC terminal to ground for negative output power supply EUTs.
- When connecting multiple output DC power supplies, at all times, the potential of the positive DC load module input (Red binding post) **MUST** be at a higher potential than that of the negative DC load module input (Black binding post). Refer to the example shown in Figure 7-2.

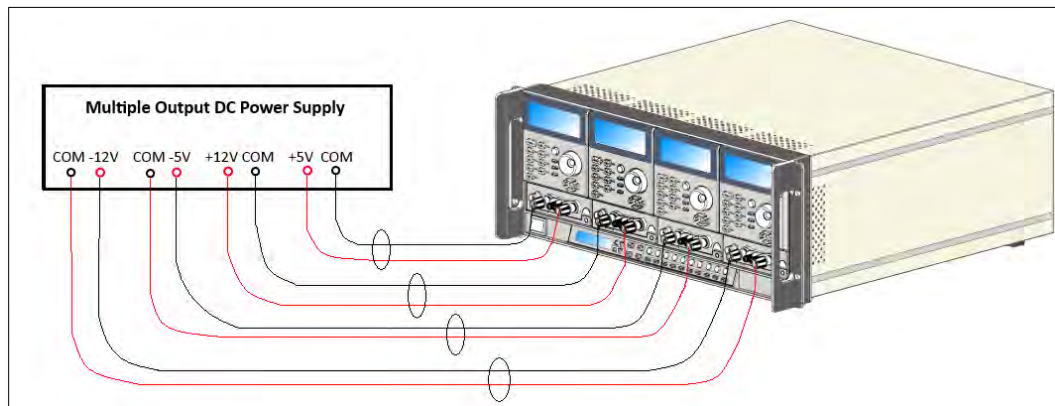

Table 7-2: Multiple Output DC Supply Polarity Connection



## 7.5 Voltage Sense Input Terminals

When the voltage sense mode is set to internal, the DC load module senses the DC at the input terminals of the DC load. Any voltage drop between the EUT and the load module across the load wires is not detected so the actual voltage at the EUT may be somewhat higher than is sensed by the load. For low current applications, the voltage drop may be negligible. Figure 7-2 shows the load connection with internal sense mode.

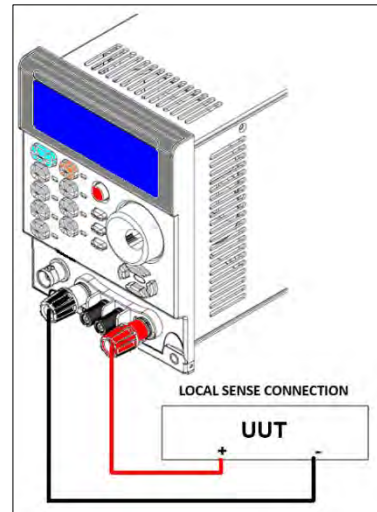

Figure 7-2: DC Load Connection with Internal Voltage Sense

To measure the UUT output DC voltage directly at the UUT terminals, external voltage sense mode must be used. The external voltage sense terminals are provided on the front panel of the load module for this purpose. Refer to Figure 7-3 for details on the V Sense terminal location and polarity. This mode is recommended for higher current applications or when voltage precision is important.

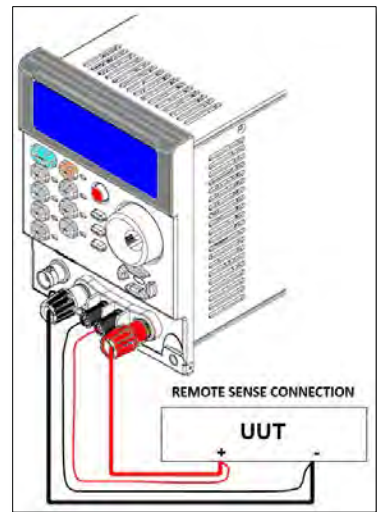

Figure 7-3: DC Load Connection with External Voltage Sense

## 7.6 Current Output Monitor (I-Monitor)

The I-Monitor terminal is designed to monitor the electronic load's input current or short current. An isolated amplifier output with 0V to 10V full scale output signal represents the zero to full scale current the electronic load is sinking.

Please refer to the I-Monitor voltage /current scaling values for each 41L Series load module in Section 4, "Technical Specifications".

### 7.6.1 Non-Isolated Output

The I-Monitor output can be used to display and capture the load current waveform on a digital storage oscilloscope to further evaluate the voltage and current waveform of a power supply under test.

**Note:** The I-Monitor is **non-isolated**. It is intended to support power supply development and testing and must be ground referenced.

To allow monitoring of both voltage and current simultaneously on a dual channel oscilloscope, care must be taken not to create ground loops. Most oscilloscope inputs are ground referenced and input channels are **not** isolated from each other.

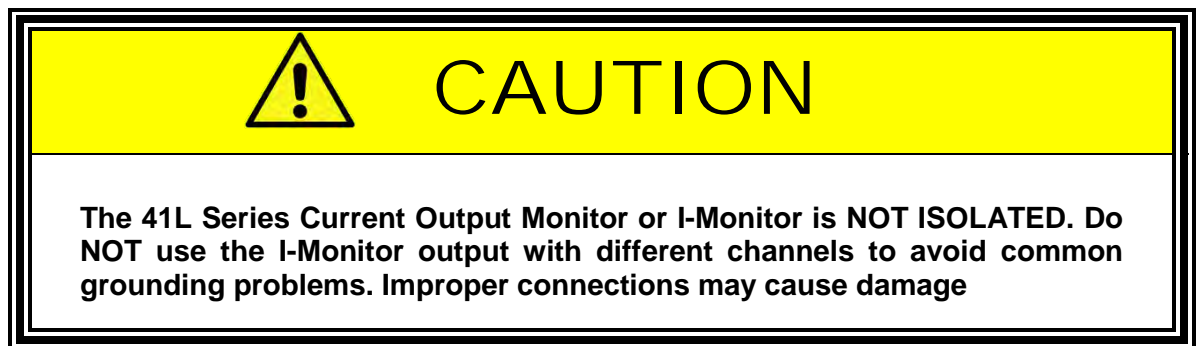

### 7.6.2 Output Impedance

The I-Monitor output volt range is 0 to 10V. Output impedance is 1K $\Omega$ . The equivalent output circuit of the I-Monitor output is shown in the figure below.

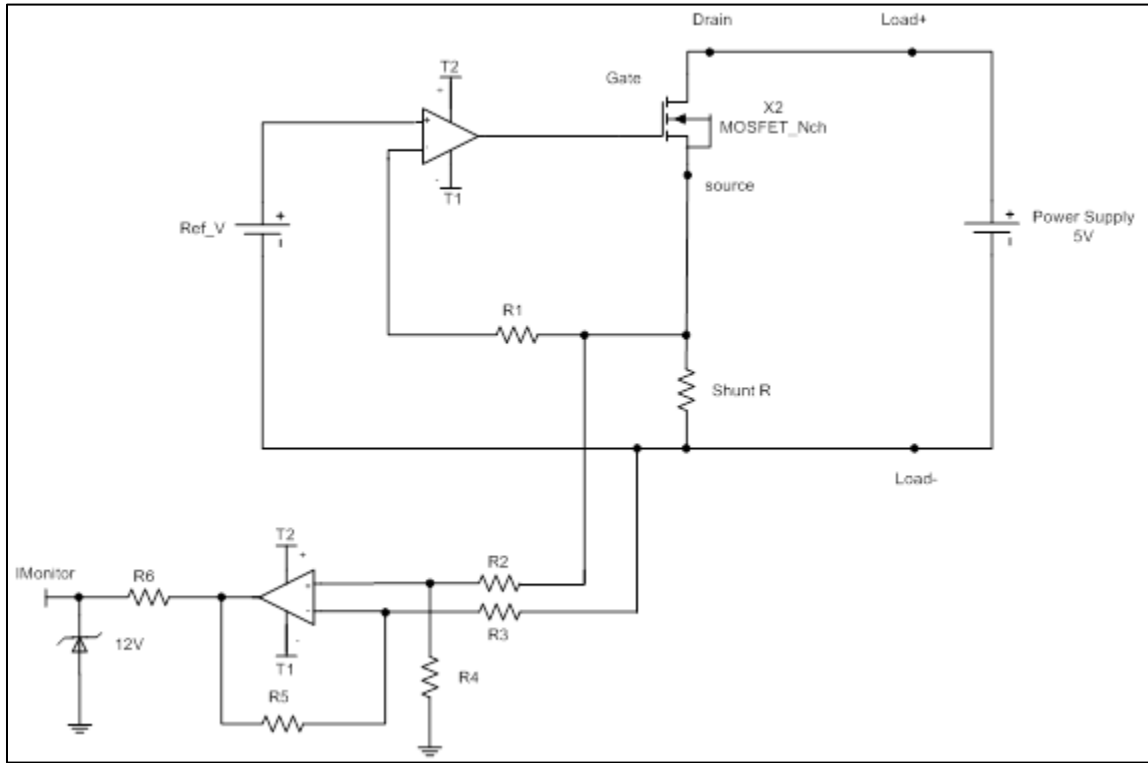

Figure 7-4: Equivalent I-Monitor Output Circuit

### 7.6.3 Connecting I-Monitor Output to an Oscilloscope

When you connect the load's current monitor to an oscilloscope, please carefully check the polarities of the scope probes of the oscilloscope as shown in Figure 7-5.

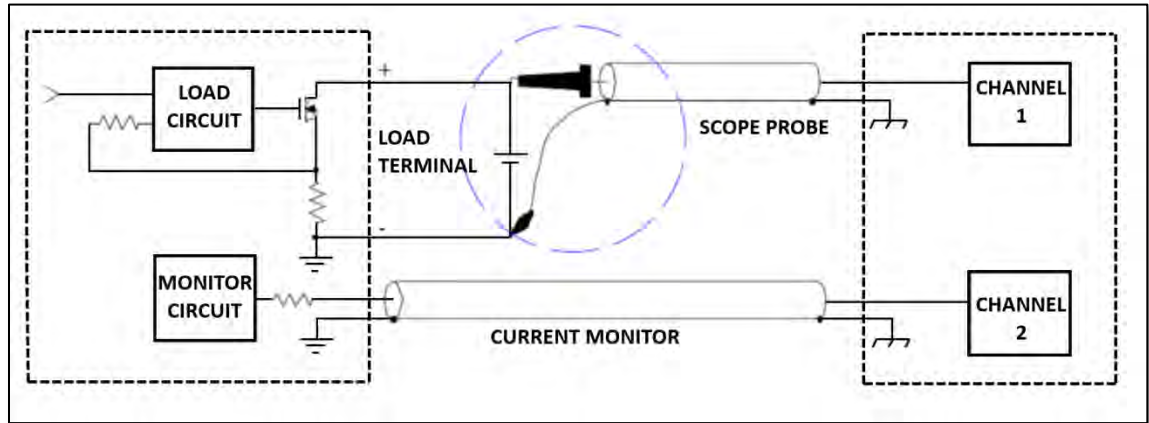

Figure 7-5: Correct I-Monitor Connections to UUT and Oscilloscope

Reversing signal and ground on the voltage probe will result in a current to flow to ground as shown in Figure 7-6 and may damage the UUT, the oscilloscope and possibly the electronic load.

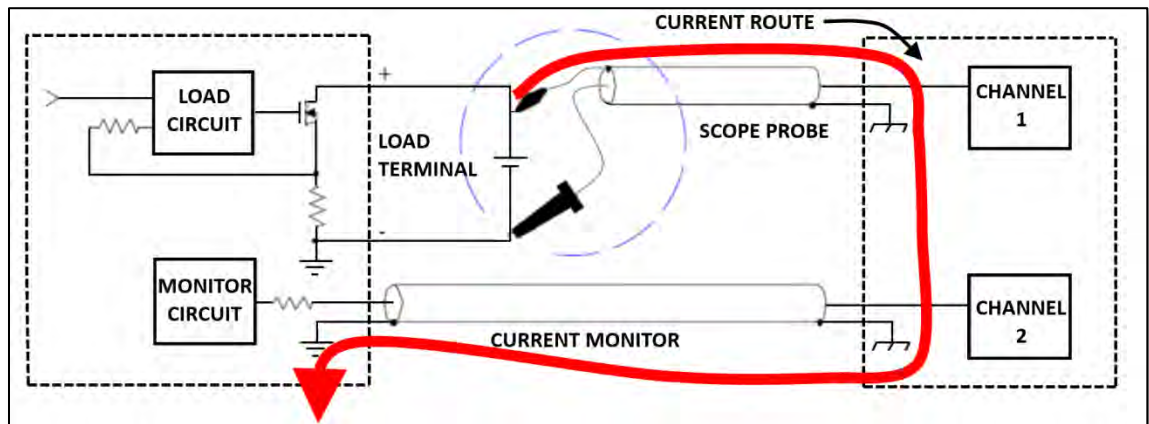

Figure 7-6: *Incorrect* I-Monitor Connections to UUT and Oscilloscope

## 7.7 Parallel Operation

It is possible to operate load modules in parallel if the power and/or current capability of a single load module is not sufficient.

### 7.7.1 Parallel Mode Connection

The positive and negative outputs of the power supply must be connected individually to each load module's input as shown in Figure 7-7 below. The setting is made at each individual load module. The total load current is the sum of the load currents being taken by each module.

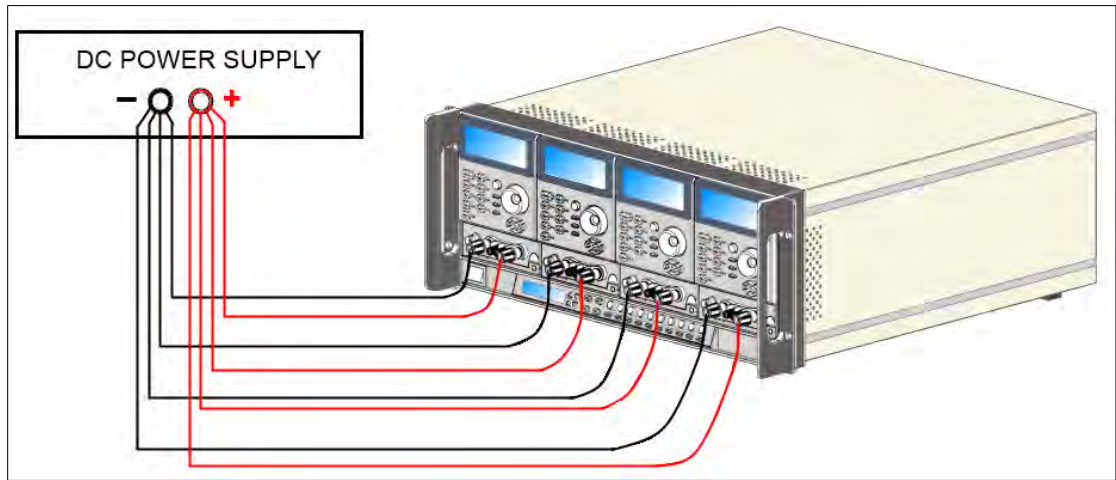

Figure 7-7: Parallel Load Connection

### 7.7.2 Allowable Operating Modes

It is permitted to operate 4 series load modules with different voltage, current and power ratings to sink in parallel. For example the loads modules shown in Figure 7-7 could be a mixture of 41L0660, 41L0630, 42L0824, and 41D1020.

While in static mode, the load modules can be set to operate in CC, CR or CP mode.

### 7.7.3 Exceptions

1. Parallel operation in DYNAMIC mode is not allowed.
2. Parallel operation in CV mode is not possible.



## 7.8 Series Operation

Series operation of dc load modules to achieve higher voltage ranges than supported by an individual load module is **NOT** allowed under any circumstance.



## 7.9 Zero-Voltage Loading

As shown in Figure 7-8, the Electronic load can be connected in series with a DC voltage source (DC power supply in CV mode) with an output voltage greater than:

- 0.6Vdc (41L0630 & 41L0660),
- 1.0Vdc (41L2512),
- 6.0Vdc (41L5012)
- 0.3Vdc (41L0615)

This allows the device under test connected to the electronic load to be operated down to a zero volt condition. The external DC voltage source provides the minimum operating voltage required by the electronic load. This application is suitable for low voltage battery cell high discharge current testing.

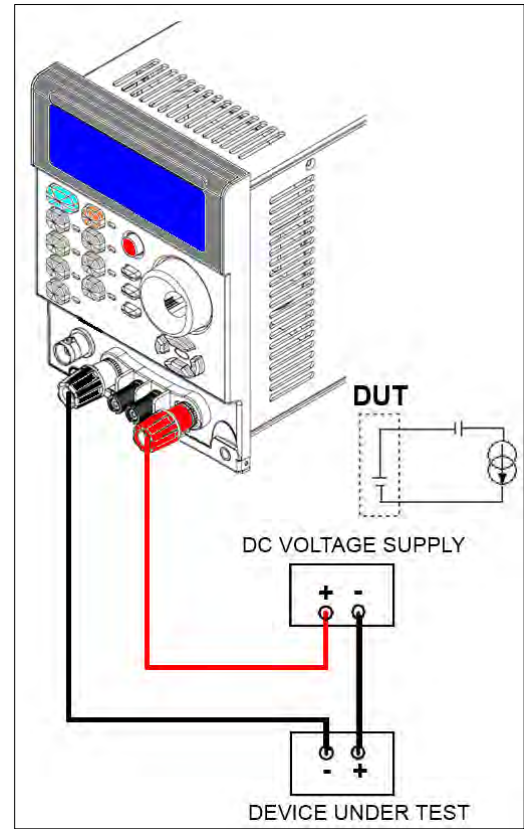

Figure 7-8: Zero Volt Load Connection

## 7.10 Protection Features

The 41L Series electronic loads include the following protection features:

- Over Voltage
- Over Current
- Over Power
- Over Temperature
- Reverse Polarity Indication

### 7.10.1 Over Voltage Protection

The over voltage protection circuit is set at a predetermined voltage depending on the load model and **cannot** be changed. If the over voltage circuit has tripped, the load input turns OFF immediately to prevent damaging the load. When an over voltage trip condition has occurred, the digital current meter's LCD display will indicate "OVP"

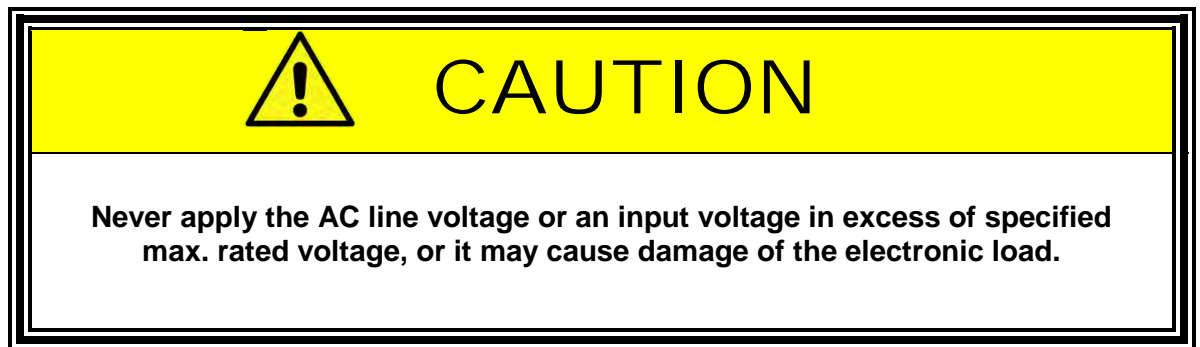

### 7.10.2 Over Current Protection

The load always monitors the current it is sinking. When the current sink is greater than 105% of the rated maximum current, the load module will turn load to OFF state internally. When an over current condition has occurred, the digital current meter's LCD display will indicate "OCP".

### 7.10.3 Over Power Protection

The load always monitors the power dissipated by the load. When the power dissipation is greater than 105% of the rated power input, the load module will turn load to OFF state internally. When an over power condition has occurred, the digital current meter's LCD display will indicate "OPP".



#### 7.10.4 Over Temperature Protection

As soon as the temperature of load's internal heat sinks reaches a level greater than 85° C (180° F), the over temperature protection is triggered. The digital current meter's LCD display will indicate "OTP". The load will turn to the OFF state internally.

Please check environmental conditions such as the ambient temperature and distance between the rear panel of the load chassis and any wall is greater than 15cm / 6 inches.

The load can reset the Over Voltage, Over Current, Overpower and Over Temperature protection if the condition that caused the fault is removed and the "LOAD" key is pressed to set "ON" state.

#### 7.10.5 Reverse Polarity Protection Indication

The 41L Series electronic load conducts reverse current when the polarity of the DC source connection is incorrect. The maximum reverse current is a function of the load model. If the reverse current exceeds the maximum reverse current, it may damage the load.

When a reverse polarity current condition exists, the reverse current is displayed on the 5 digit current meter on the front panel, and the 5-digit DVM indicates a **negative** current reading. Whenever a reverse current is displayed on the current meter, turn OFF power to the DC source immediately and make the correct connections.

## 8 Auto Sequence Programming Examples

### 8.1 Overview

An auto-sequence allows the user to step through previously saved set-ups stored in the mainframe's memory. Up to nine auto-sequences can be saved. Each auto-sequence can consist of up to sixteen steps. There are two modes available for the auto-sequence function. These are **edit mode** - to set up an auto-sequence and **test mode** - to recall and start an auto-sequence execution.

### 8.2 Edit Mode

To set up a new auto-sequence using the Edit mode, proceed as follows:

1. Set-up all load parameters such as the operating mode, along with sink values and the LOAD ON/OFF status. Configuration and limit settings can also be set and the NG ON function may be selected as part of the setup.
2. Press the STORE key and one of the numbered STATE keys to store the set up in one of the memory locations. The BANK number can also be changed to provide additional memory locations.
3. Repeat the previous steps as needed to create additional load set-ups and saved them to separate memory locations using the STORE, BANK and STATE keys.
4. Once the required number of load setups has been saved enter the EDIT mode by pressing the EDIT key. The EDIT key will light up indicating the EDIT mode is active.
5. With the EDIT button lit, the auto-sequence identity (F1 to F9) can be selected using the numbered STATE keys.
6. Now select the first memory location by pressing the up/down arrow keys to select the BANK and STATE. This will become the first step of the AUTO-SEQUENCE.
7. Press ENTER to set the chosen BANK and STATE memory location.
8. Using the arrow keys set the test time (T1) and NG/LIMIT checking time (T2) for that step of the auto-sequence.
9. Press ENTER to save the time setting and move onto the next step of the auto-sequence.
10. Repeat steps 6 to 9 to as needed to enter up to 16 steps to form the auto-sequence.
11. Once the desired number of steps have been set, press the STORE button.
12. The LCD will show REP (repetitions).
13. Use the arrow keys to set the number of auto-sequence repetitions.
14. Press STORE to confirm the sequence edit.

This completes the programming sequence.

### 8.3 Test Mode

To execute a previously stored auto-test sequence, proceed as follows:

1. Press the TEST key on the mainframe to enter the TEST mode.
2. Use the numbered STATE keys (1 to 9) to select the previously saved auto-sequence.
3. Press ENTER to start the auto-sequence.
4. The LCD shows "PASS" or "FAIL" after testing.  
If limits and the NG functions have been set and a test step fails, the mainframe LCD display will flash "NG". The user must then press ENTER to continue the auto-sequence execution or EXIT to abort the auto-sequence.
5. Press auto-sequence or EXIT at any time to abort an auto-test sequence.

### 8.4 AUTO TEST SEQUENCE Example

In this example, we will create a program based on following illustration of a varying current over time. A total of eight sequence steps will be needed to implement this sequence. The program executes steps 1 to 8 in sequence.

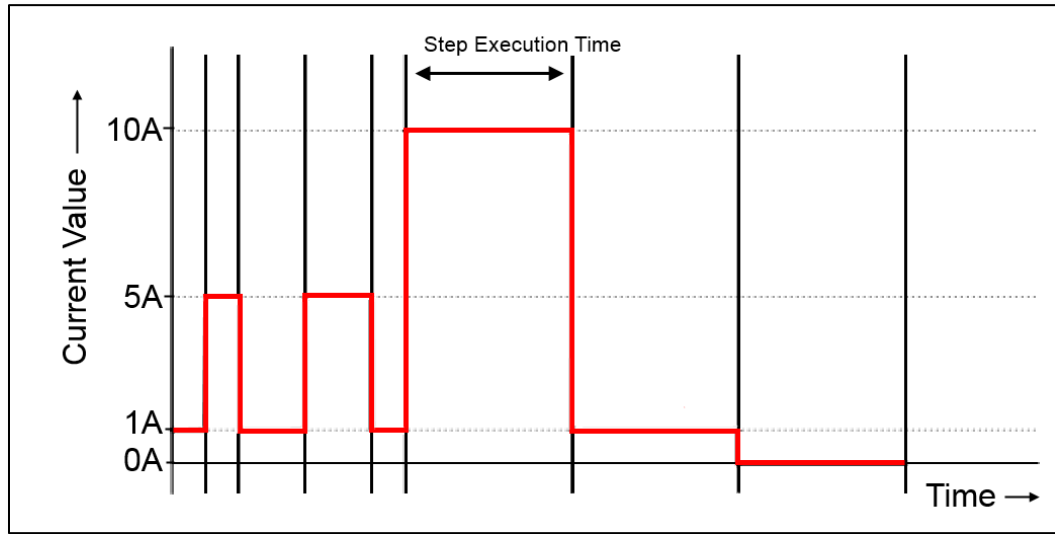

Figure 9-1: Auto-Test Sequence Example Illustration

The desired current levels and durations are shown in the table below.

| Auto-sequence Step number | Memory BANK | Memory STATE | Current Value | Execution Time (T1+T2) |
|---------------------------|-------------|--------------|---------------|------------------------|
| 1                         | 3           | 1            | 1.0 Adc       | 200 ms                 |
| 2                         | 3           | 2            | 5.0 Adc       | 200 ms                 |
| 3                         | 3           | 3            | 1.0 Adc       | 400 ms                 |
| 4                         | 3           | 4            | 5.0 Adc       | 400 ms                 |
| 5                         | 3           | 5            | 1.0 Adc       | 200 ms                 |
| 6                         | 3           | 6            | 10.0 Adc      | 1000 ms                |
| 7                         | 3           | 7            | 1.0 Adc       | 1000 ms                |
| 8                         | 3           | 8            | 0.0 Adc       | 1000 ms                |

Table 9-1: Auto-Test Sequence Example Values

To program this sample sequence, proceed as follows:

1. Set the operation mode: Press the mode key to CC mode.
2. Set the range: Press RANGE key to force range 2.
3. Set LOAD ON/OFF Status: Press load ON.
4. Set the current values steps 1-8 and store to memory BANK 3 STATES 1-8.
5. Press EDIT key.
6. Press the number 2 key to select F2 as the auto sequence location.
7. Press up/down key to memory bank 3 and state 1.
8. Press ENTER key to confirm the sequence memory.
9. Press up/down key to set the test time for that step (T1+ T2).
10. Press ENTER key to confirm the sequence step.
11. Repeat steps 7 to 10 to set auto-sequence steps 1-8.
12. After setting the final step, press the STORE key.
13. Press up/down key to 1 to repeat the auto-sequence one time.
14. Press STORE key to confirm the number of repetitions.
15. Press TEST key to enter TEST mode.
16. Press number 2 to select auto-sequence F2.
17. Press ENTER to confirm selection and start TEST.
18. The load will now step through the auto-sequence.

The current test waveform can be checked on an oscilloscope as shown below - assuming that the DC source can supply the programmed load currents.

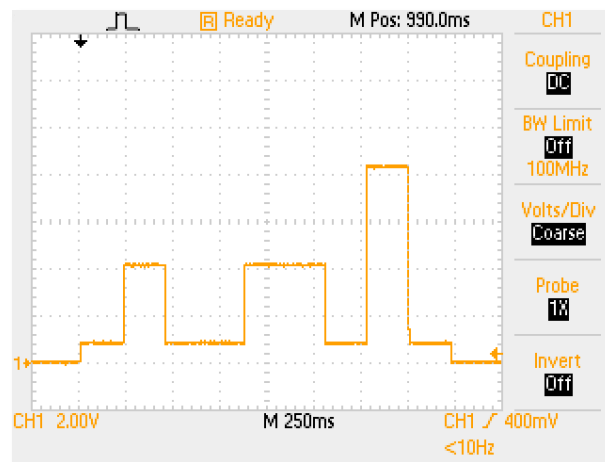

## 9 Short Circuit, OPP and OCP Test Examples

### 9.1 Overview

This appendix provides examples on how to program the built-in test modes of the 5 Series loads. These tests allow commonly used functional testing of power supplies with minimal programming effort.

The parameters for the Short, Over Power Protection and Over Current Protection tests can all be programmed over the optional computer interfaces. The following examples may prove useful.

### 9.2 SHORT Test

To invoke short circuit testing of a unit under test, send the following sequence of commands to the load:

#### SHORT Test

This example sets a short test for 500ms until the STOP command is received.

|               |   |
|---------------|---|
| REMOTE        | Set Remote                                |
| TCONFIG SHORT | Set SHORT test function                   |
| STIME 500     | Sets short time to 500ms time*            |
| START         | Start SHORT testing                       |
| TESTING?      | Ask Testing?     1:Testing, 0:Testing End |
| STOP          | Stop SHORT testing                        |

\* if 500 is replaced with 0 the short test is continuous until STOP command

### 9.3 OPP Test

To invoke over power protection circuit testing of a unit under test, send the following sequence of commands to the load:

#### OPP Test

In this example, threshold limits are set and the NG signal is enabled.

|             |                        |                          |
|-------------|------------------------|--------------------------|
| REMOTE      | Set Remote             |                          |
| TCONFIG OPP | Set OCP test           |                          |
| OPP:START 3 | Set start load watt 3W |                          |
| OPP:STEP 1  | Set step load watt 1W  |                          |
| OPP:STOP 5  | Set stop load watt 5W  |                          |
| VTH 0.6     | Set OPP VTH 0.6V       |                          |
| WL 0        | Set watt low limit 0W  |                          |
| WH 5        | Set watt high limit 5W |                          |
| NGENABLE ON | Set NG Enable ON       |                          |
| START       | Start OPP testing      |                          |
| TESTING?    | Ask Testing?           | 1:Testing, 0:Testing End |
| NG?         | Ask PASS/FAIL?         | 0:PASS,1:FAIL            |
| OPP?        | Ask OPP watt value     |                          |
| STOP        | Stop OPP testing       |                          |



## 9.4 OCP Test

To invoke over current protection circuit testing of a unit under test, send the following sequence of commands to the load:

### OCP Test

This test will start sinking current at 3A and increase to 5A in 1A steps.

|             |                                       |
|-------------|---------------------------------------|
| REMOTE      | Set Remote                            |
| TCONFIG OCP | Set OCP test                          |
| OCP:START 3 | Set start load current 3A             |
| OCP:STEP 1  | Set step load current 1A              |
| OCP:STOP 5  | Set stop load current 5A              |
| VTH 0.6     | Set OCP VTH 0.6V                      |
| IL 0        | Set current low limit 0A              |
| IH 5        | Set current high limit 5A             |
| NGENABLE ON | Set NG Enable ON                      |
| START       | Start OCP testing                     |
| TESTING?    | Ask Testing? 1:Testing, 0:Testing End |
| NG?         | Ask PASS/FAIL?,0:PASS,1:FAIL          |
| OCP?        | Ask OCP current value                 |
| STOP        | Stop OCP testing.                     |

## 10 Remote Control Programming

### 10.1 Overview

Program command syntax for all 4 Series load modules is contained in the 44M0X mainframe operation manuals. Refer to any of the 44M01, 44M02 or 44M04 operating manuals for the 4 Series mainframe:

Mainframe model 44M01: P/N 160901-10

Mainframe model 44M02: P/N 160902-10

Mainframe model 44M04: P/N 160904-10

## 11 Calibration

### 11.1 Overview

All APS products ship with factory calibration. No additional calibration is required when first received.

### 11.2 Calibration Interval

The recommended calibration interval for these loads is one year (12 months). Routine annual calibration can be performed by most calibration labs that have low frequency measurement and power calibration capabilities. Alternatively, the load can be returned to the manufacturer to obtain a factory calibration.

### 11.3 Calibration Coefficients

The 44M04 mainframe requires no calibration but the 41L, 42L, 41D and 42D load modules do. All calibration is performed through software. No manual internal adjustments have to be made as part of routine calibration.

Calibration coefficients for the following parameters and functions are stored in non-volatile memory:

| Parameters                 | Coefficients Stored                                    |
|----------------------------|--|
| <b>Load Current</b>        | All modes, DC, Offset and Gain, High Range & Low Range |
| <b>Resistance</b>          | All modes, DC, Offset and Gain, High Range & Low Range |
| <b>Voltage Measurement</b> | DC, Offset and Gain                                    |
| <b>Current Measurement</b> | DC, Offset and Gain                                    |
| <b>Power Measurement</b>   | DC, Offset and Gain                                    |

### 11.4 Calibration Procedures

Certified calibration labs may request a copy of the calibration manual for the relevant load model by contacting the nearest Adaptive Power Systems company location. Refer to Section 1, "Contact Information".

## 12 CE MARK Declaration of Conformity

**Directive:** 2004/108/EC

**Product Name** 41L Series, 42L Series, 41D Series, 42D Series DC Electronic Loads

**Serial Number** \_\_\_\_\_

**The manufacturer hereby declares that the products are in conformity with the following standards or other normative documents:**

**SAFETY:**

Standard applied IEC 61010-1:2001

**EMC:**

Standard applied EN 61326-1:2006

**Reference Basic Standards:**

**EMISSIONS:**

CISPR11: 2003+A1: 2004+A2: 2006  
EN 61000-3-2: 2006  
EN 61000-3-3: 2008

**IMMUNITY:**

IEC 61000-4-2: 2008  
IEC 61000-4-3: 2008  
IEC 61000-4-4: 2004 +Corr.1: 2006 +Corr.2: 2007  
IEC 61000-4-5: 2005  
IEC 61000-4-6: 2003+A1: 2004+A2: 2006  
IEC 61000-4-8: 2001  
IEC 61000-4-11: 2004

**Supplemental Information:**

**When and Where Issued:** March 28, 2014  
Irvine, California, USA

**Authorized Signatory** Loc Tran  
Quality Assurance Inspector  
Adaptive Power Systems

**Responsible Person** Joe Abranko  
Adaptive Power Systems  
17711 Fitch  
Irvine, California, 92649, USA



**Mark of Compliance**

## 13 RoHS Material Content Declaration

The table below shows where these substances may be found in the supply chain of APS's products, as of the date of sale of the relevant product. Note that some of the component types listed above may or may not be a part of the enclosed product.

| Part Name                          | Hazardous Substance |           |           |             |            |             |
|------------------------------------|---------------------|-----------|-----------|-------------|------------|-------------|
|                                    | <i>Pb</i>           | <i>Hg</i> | <i>Cd</i> | <i>Cr6+</i> | <i>PBB</i> | <i>PBDE</i> |
| PCB Assy's                         | x                   | 0         | x         | 0           | 0          | 0           |
| Electrical Parts not on PCB Assy's | x                   | 0         | x         | 0           | 0          | 0           |
| Metal Parts                        | 0                   | 0         | 0         | x           | 0          | 0           |
| Plastic Parts                      | 0                   | 0         | 0         | 0           | x          | x           |
| Wiring                             | x                   | 0         | 0         | 0           | 0          | 0           |
| Packaging                          | x                   | 0         | 0         | 0           | 0          | 0           |

### Legend:

0: Indicates that the concentration of the hazardous substance in all homogeneous materials in the parts is below the relevant RoHS threshold.

x: Indicates that the concentration of the hazardous substance of at least one of all homogeneous materials in the parts is above the relevant RoHS threshold.

### Notes:

1. APS has not fully transitioned to lead-free solder assembly at this point in time. However, the vast majority of components used in production are RoHS compliant.
2. These APS products are labeled with an environmental-friendly usage period in years. The marked period is assumed under the operating environment specified in the product specifications.

Example of marking for a 10 year period.









# Index

---

## A

AC Input .....24  
 Accessories .....20

---

## C

Configuration .....40, 80  
 Connections .....35, 69, 75  
 Constant Current ..13, 14, 15, 18, 23, 24, 37, 40, 41, 43, 44, 45, 51, 55, 59, 60, 61, 63, 66, 67, 68, 76, 83  
 Constant Power ....13, 15, 18, 23, 37, 40, 41, 43, 44, 45, 51, 56, 59, 62, 66, 67, 68, 76  
 Constant Resistance....13, 14, 23, 40, 41, 43, 44, 45, 51, 57, 59, 61, 66, 67, 68, 76  
 Constant Voltage ..13, 14, 23, 40, 41, 43, 44, 45, 51, 59, 62, 65, 66, 67, 68, 76, 77  
 Contact .....8, 34, 88  
 Contents .....3  
 Cooling.....24

---

## D

Display .....42, 43, 58  
 Dynamic mode.....44, 49, 59

---

## F

Features .....19, 69, 78  
 Frequency .....16  
 Front panel operation .....41

---

## G

Go/NoGo.....40, 46, 60, 61, 62

---

## I

Installation .....9, 21, 32, 33, 58

---

## L

LED .....44, 45, 46, 48, 49, 51, 54, 55, 56  
 Level .....45

---

## M

MPP .....53, 64, 65  
 MPPT.....42, 51, 53, 63, 65, 66, 67, 68

---

## O

OCP test.....42, 43, 55, 85, 86  
 OPP test.....42, 43, 56, 85

---

## P

Parallel operation .....76  
 Programming.....36, 39, 65, 80, 87  
 Protection.....23, 40, 69, 78, 79, 84  
 PV Panel .....63

---

## S

Series operation .....76  
 Short test.....42, 43, 54  
 Size .....70  
 Slew rate .....16  
 Specifications .....23, 38, 73

---

## T

Terminals.....69, 72  
 Turn on .....34

---

## W

Warranty .....9  
 Waveform .....16  
 Weight.....25