

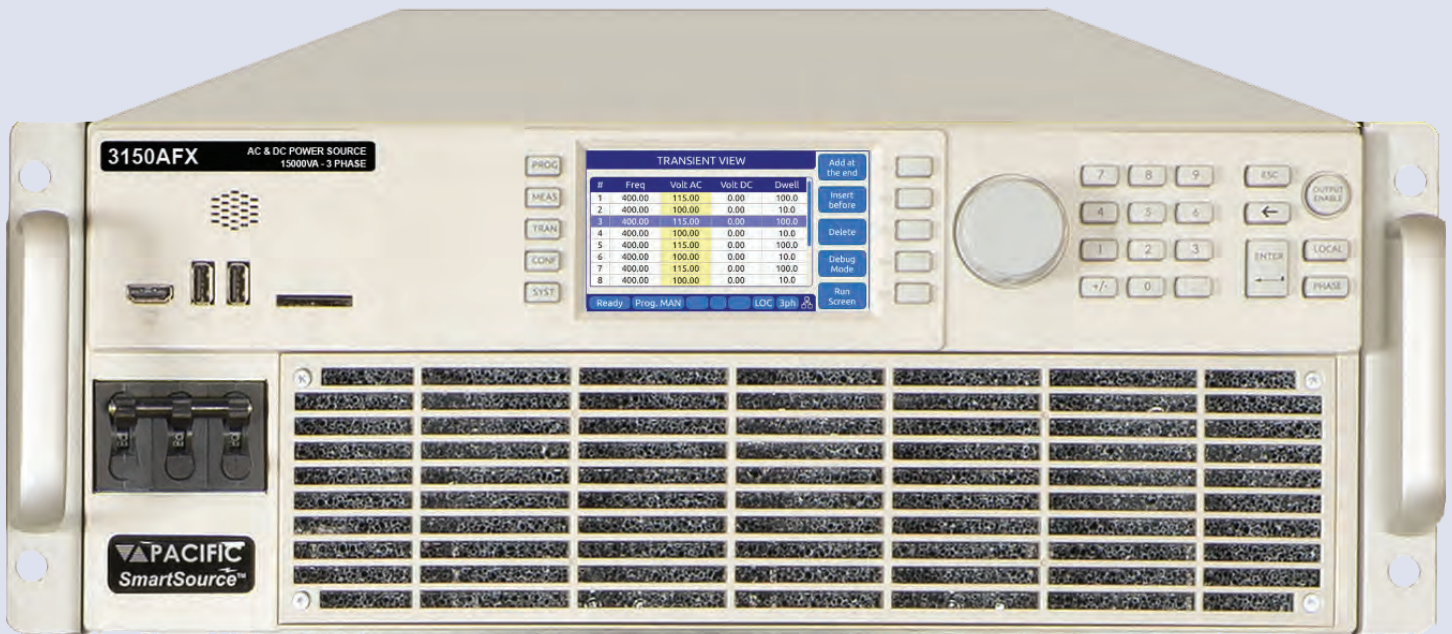

**PACIFIC**<sup>®</sup>  
POWER SOURCE

# AFX SERIES

## High Performance Programmable AC & DC Power Sources



*"Advanced, All Digital Power Conversion Technology"*

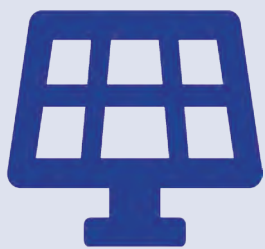

RENEWABLE ENERGY

AEROSPACE & DEFENSE

PRODUCTION TEST

EV CHARGING

IEC COMPLIANCE

# Powerful yet Easy to Use

Although the AFX Series of programmable AC and DC power sources offer a wide range of operating modes and features, they are easy to operate through a large color touch screen LCD display and soft key driven menus.

Top level menus are accessible by pressing any of the five menu keys on the left of the display. Entering setup data is accomplished using the numeric keypad or the shuttle. Operating status is shown on screen using various colors to distinguish between setting, measurements and operator warnings, or error messages.

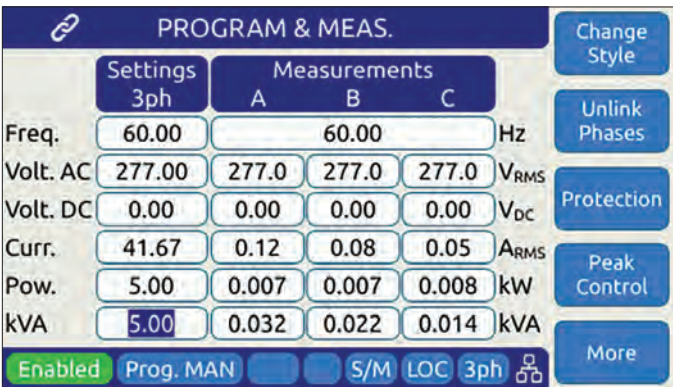
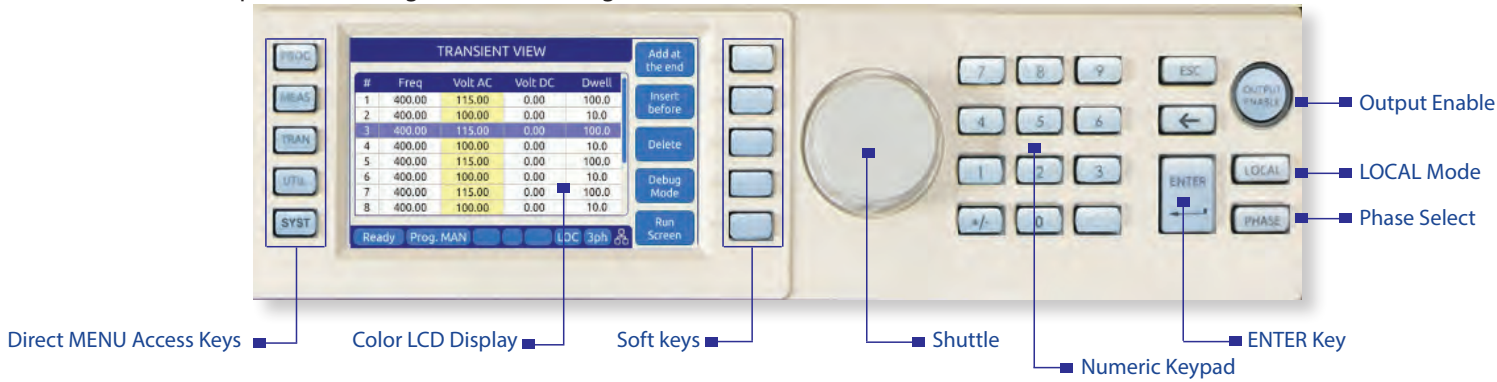

Output Program & Measurement Screen

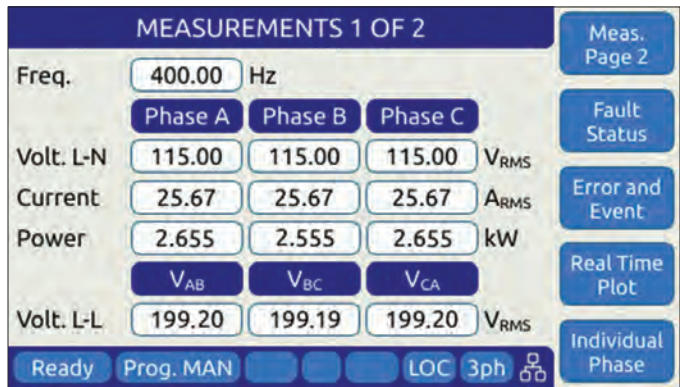

Measurement Only Screen

# Transient Programming

Voltage, Waveform and Frequency output transients are easily created from the front panel using an intuitive spreadsheet style data entry method. Data may be entered for a specific phase or for all three phases at the same time. Transients are supported in AC, DC and AC+DC modes of operation.

The AFX Series supports LIST, PULSE and STEP Mode Transient Types. The user can select the most appropriate type from the front panel or the web browser interface. The images below illustrate the three modes graphically. Transients can be stored in non-volatile memory and easily edited as needed from the front panel. Transient programming and execution can also be accomplished using the built-in web browser interface.

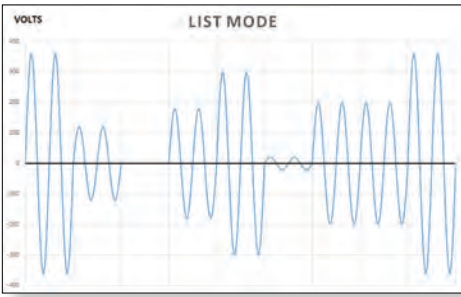
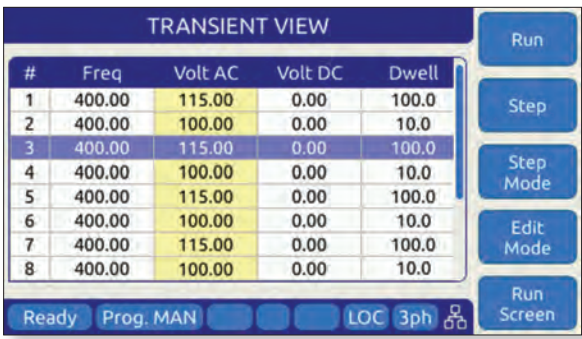

TRANSIENT LIST MODE

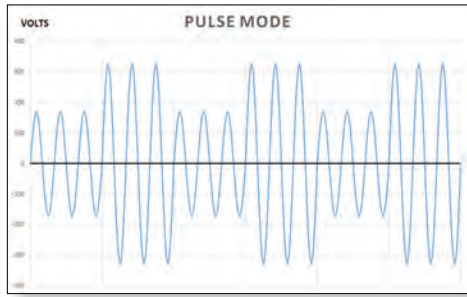

TRANSIENT PULSE MODE

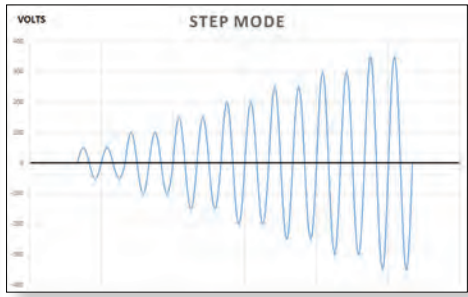

TRANSIENT STEP MODE

## Constant Power Mode AC and DC Voltage Ranges

Many AC power sources use dual voltage ranges to provide either high voltage or high current but not at the same time. By contrast, the AFX Series uses a single voltage range that operates along a constant power curve. This provides both more current at lower voltages and higher voltage at lower currents. A single voltage range eliminates the need to switch between two voltage ranges, thus providing a much wider operating range. This expanded operating area is shown as the blue area in the figure below.

Switching between two voltage ranges on an AC source causes the output to be turned **off** while the output state is reconfigured, resulting in the EUT likely shutting down. This makes it difficult to test universal wide input range AC products. The blue line and shaded area in the chart shows the additional operating range available compared to a conventional AC power source with a 150V/300V range pair.

The same applies to DC mode of operation where a constant power 425Vdc voltage range is used to provide both high DC current and DC voltage.

*Extended Operating Range for model 3150AFX (15kVA) along a constant 5 kVA per phase power curve for each phase. Other AFX models have same profile but different power & current levels.*

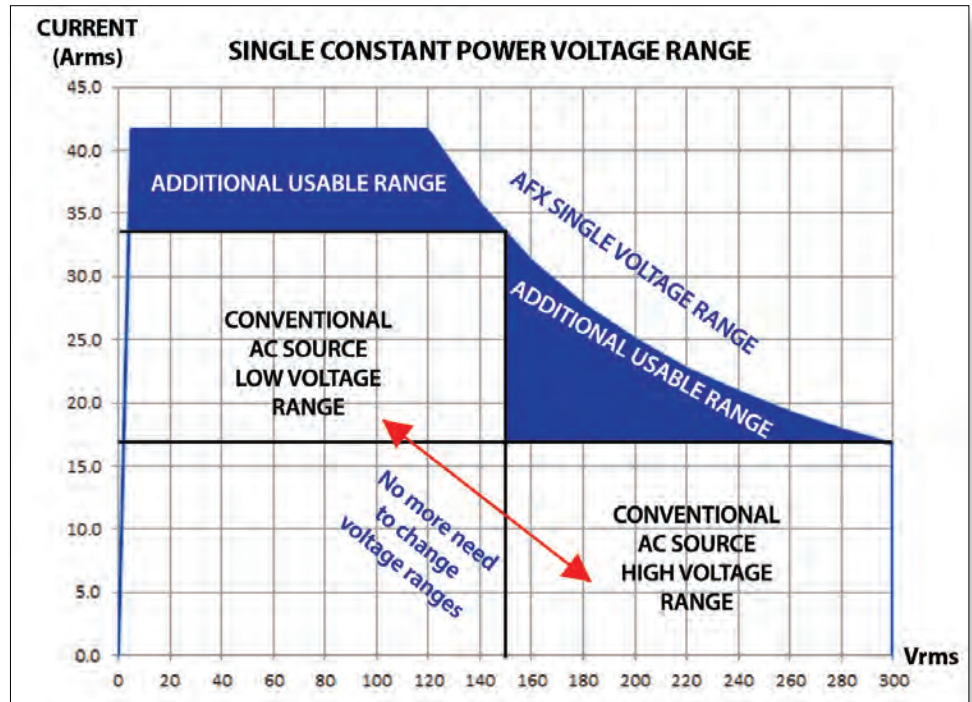

## Extended Voltage Range Operation to 333Vac LN

Extended range increases the maximum output voltage to 333Vac L-N / 576Vac L-L over a frequency range from 45Hz to 800Hz. This supports over-voltage testing up to 20% of 480V nominal powered equipment. It also allows testing of single phase universal 90V ~ 265V AC input products to 120% of their maximum nominal input specification.

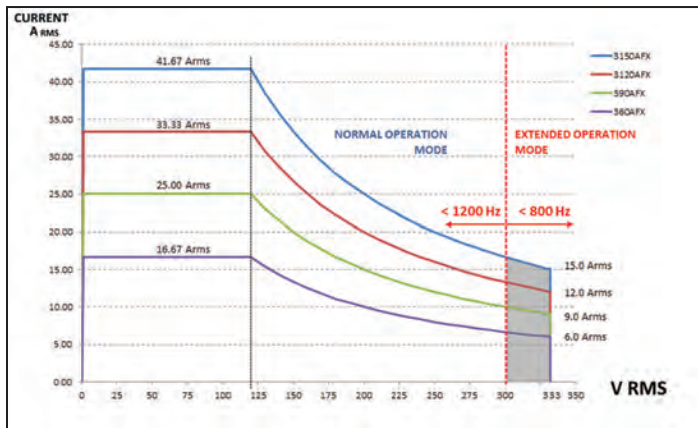

Three Phase Mode Extended Voltage Range Constant Power Profile

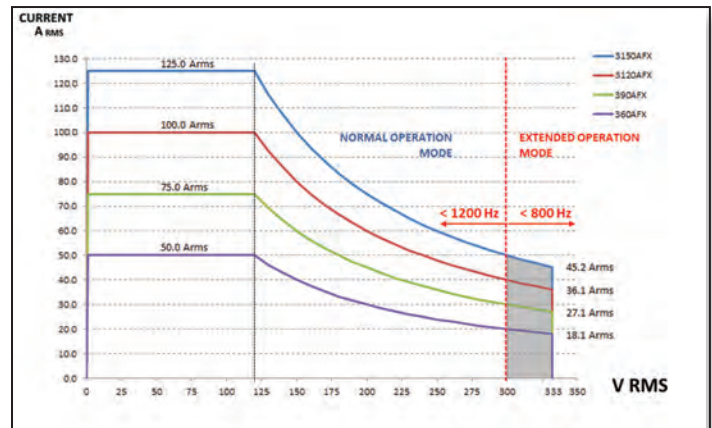

Single Phase Mode Extended Voltage Range Constant Power Profile

## Extended Frequency Range

The available extended frequency range mode allows operation beyond the 15 to 1200 Hz full specification bandwidth. Extended mode allows operation from 1Hz to 3000Hz with some power or voltage derating. The allowable voltage, current and power profiles for three phase mode from 1200~3000Hz are shown in the two left side graphs below. For operation below 15Hz (1~15Hz), only power output is derated as shown in the third graph. As is the case for Extended Voltage mode described above, supplemental voltage distortion specifications apply.

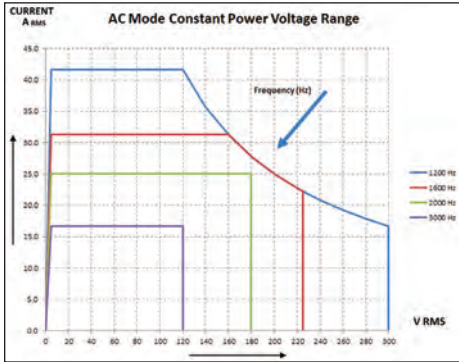

Three Phase Mode 1200~3000Hz Freq. Voltage Range

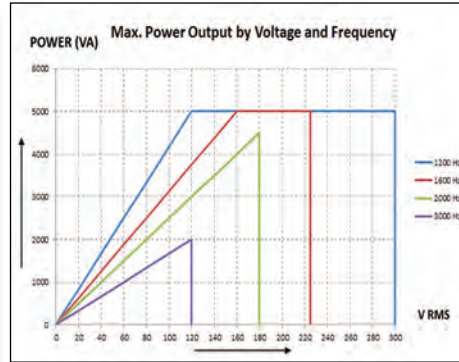

Three Phase Mode 1200~3000Hz Freq. Range Power

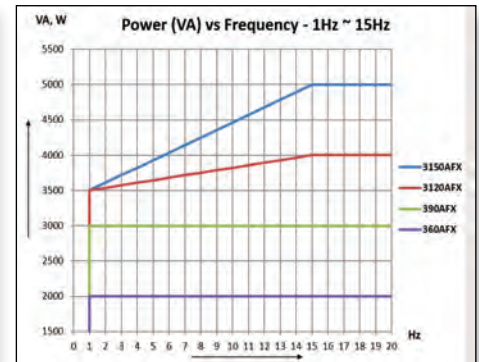

Three Phase Mode 1~15Hz Freq. Range Power

## Programmable Output Impedance

Standard programmable Output Impedance (Prog-Z) allows programming of source output R and L impedance. User selectable modes are Real-Time for fast response times or RMS for higher precision. Programmable range values for R and L are the same in both modes. This allows optimal use of programmable output impedance for a wide range of applications.

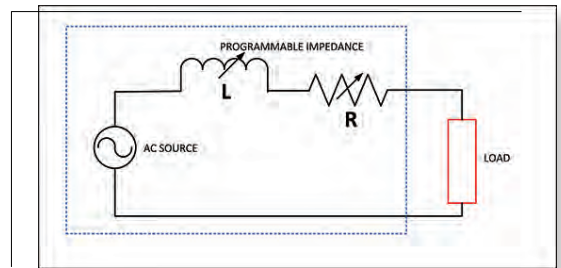

## Parallel Operation for High Power Applications



AFX Series power sources support auto-parallelism of two or more units. Paralleled units must have the same power rating. Auxiliary no-controller (AFX-NC) models are available to build cost-effective, high power, parallel systems. Parallel configurations are available in **kit form** for system integrators using their own cabinets. Complete integrated 19" Rack parallel systems are available as well, including input and output power terminals.

Using one 3150AFX master 15kVA unit and five 3150AFX-NC 15kVA Auxiliary units, a 90kVA system fits in a standard height 19" Cabinet. For redundancy purposes, two of the six power sources can be master units as desired. Paralleled AFX Systems will automatically configure as the Master 3150AFX will detect how many other units are connected. Parallel AFX Series system configurations are available up to 180kVA.

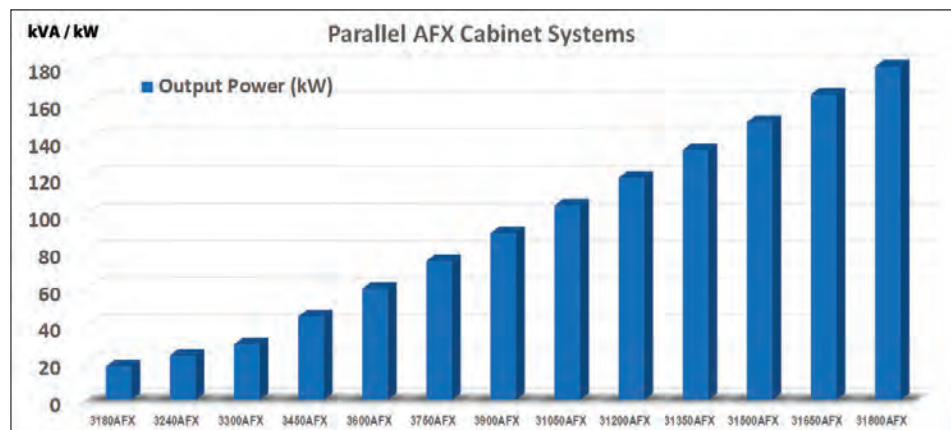

## Series Mode Output Configuration (S Option - Not Available in all Regions)

The "S" version of the AFX series allows a pair of AFX power sources to be connected in series to double the available output voltage in both AC and DC modes. This yields output voltages of 600Vac RMS Line to Neutral or 1040Vac Line to Line in three phase mode. In DC mode, ±850Vdc is available. A 30kVA/kW 3300AFXS system is shown below.

For applications where both high and low voltage ranges are required, a Series/Parallel Mode Switch option (SPMS) is available for AFXS Series systems up to 60kVA. The SPMS option allows output wiring configurations to be selected as either series or parallel from the Master unit's front panel, web browser interface or using a bus command from a test program for series systems.

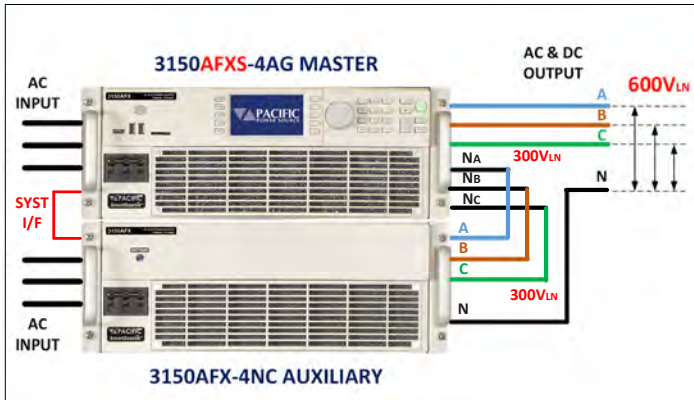

30kVA Series Output Configuration

MODEL	POWER	V RANGE	19" CABINET
3120AFXS	12kVA / kW	0-600 Vac LN 0-1040 Vac LL  0- ±850 Vdc	28U
3180AFXS	18kVA / kW		28U
3240AFXS	24kVA / kW		28U
3300AFXS	30kVA / kW		28U
3600AFXS	60kVA / kW		28U
3900AFXS	90kVA / kW		36U
SPMS	Automatic Series and Parallel Mode Configuration Switch. Max. power level is 60kVA.		

**Note:** Examples shown here are typical bundled configurations. Other configurations and number of units using 6kVA, 9kVA or 12kVA AFXS models are available on request. Contact your local representative or Pacific Power Source for details.

## High Voltage Output Transformer (T Option)

For applications that require an AC output voltage higher than 333Vac LN, an external output transformer option is available. With this T option, an additional AC only mode range is added to the AFX capable of supporting the following output voltage ranges depending on phase mode:

- |                     |                    |                       |
|---------------------|--------------------|-----------------------|
| <b>Single Phase</b> | <b>Split Phase</b> | <b>Three Phase</b>    |
| 0-400 VL-N          | 0-800 VL-L         | 0-400 VL-N/0-692 VL-L |

Standard AC and DC voltage ranges remain available. For voltages higher than 400VL-N, contact factory.

### Constant Power Mode

The 400V transformer range has a constant power profile. That means full power is available all the way down to 160 Vac L-N/277 Vac L-L on the 400V range. See V-I profiles chart to the right.

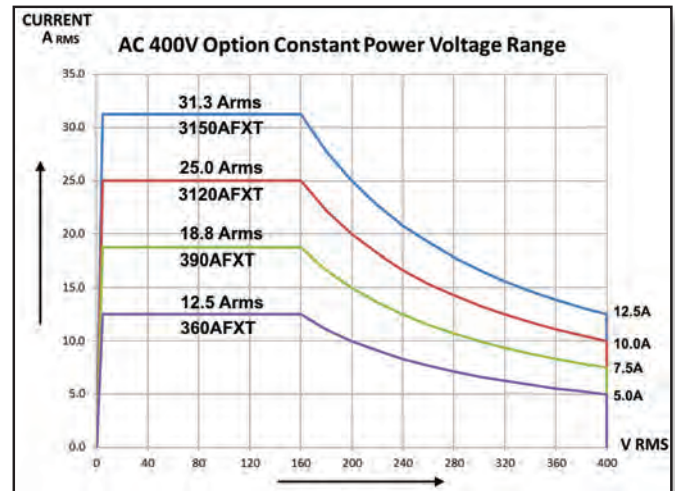

Three Phase Mode 400 V Range Constant Power Profile

## T Option - Technical Specifications

ELECTRICAL	SPECIFICATIONS
Output Mode	AC Only. No DC or AC+DC modes on T Option range
Voltage Range	0-400 Vac LN / 0-692Vac LL
Resolution	0.01 V
Accuracy	± (0.25% + 0.25* f (kHz)) F.S.
Voltage Sense	Auto scales for T option range
Frequency Range	45Hz - 1000Hz Derating: Voltage < 45Hz, Current > 1000Hz
Constant Power Mode	From 40% to 100% of V range

MECHANICAL	SPECIFICATIONS
<b>Mechanical - T Option Chassis (15kVA rated)</b>	
H x W x D	7.0" x 17.0" x 25.0" 178 x 482 x 635 mm
Weight	170 lbs. / 77.1 kg
<b>Mechanical - Cabinet Systems</b>	
Dimensions / Weight	Refer to AFX Cabinet Systems data sheet

*Note 1: Extended frequency ranges are not supported on this optional AC coupled voltage range.*

## Technical Specifications

PARAMETERS / FUNCTIONS	SPECIFICATIONS			
<b>OUTPUT VOLTAGE</b>				
Modes	AC, DC, AC+DC, DC+AC			
Phase Modes	Single Phase (FORM1), Split Phase (FORM2), Three Phase (FORM3)			
Voltage Ranges	AC: 0 - 300 Vrms LN / 0 - 520 Vrms LL   DC: 0 - 425 Vdc			
Extended Voltage Ranges	AC: 0 - 333 Vrms LN / 0 - 576 Vrms LL   T Option: 400V or 600   Series Mode: 0 - 600V			
Programming Resolution & Accuracy	0.01 V   $\pm 0.25\%$ Full Scale			
Waveforms (Max. = 200)	Sine, Square, Triangle, Clipped Sine (THD), Saw Tooth, Triangle, Arbitrary			
DC Offset	< 20 mV dc			
Harmonic Distortion (R load)	< 100 Hz < 0.3%   100 - 500 Hz < 0.5%   500 - 1000 Hz < 1.0%   > 1000 Hz < 1.5%			
Switching Noise	< 150 mV RMS   DC to 300 kHz			
Load Regulation	AC Mode: $\pm 0.02\%$ (CSC Mode ON)		DC Mode: $\pm 0.02\%$ (CSC Mode ON)	
Line Regulation	AC Mode: < 0.1% for 10% AC Line input change, < 0.02% with CSC Mode ON			
Voltage Sense - External	External or (Auto) Internal Sense   Max. voltage drop 5% of Full Scale			
Output Isolation	550 Vac			
Voltage Slew Rate	Programmable   AC > 1.0 V/ $\mu$ sec   DC > 3.0 V/ $\mu$ sec			
<b>OUTPUT FREQUENCY</b>				
Frequency Ranges	Standard Range: DC, 15.00 Hz - 1200.0 Hz   Extended Range <sup>1</sup> 1.00 Hz - 3000.0 Hz			
Programming Resolution & Accuracy	0.01 Hz   $\pm 0.01\%$			
<b>Output Current</b>				
Current Limit	RMS Mode & Peak Current Mode			
Range	RMS: See Model table page 9		Peak Current: 104 Apk/phs max per AFX unit	
Crest Factor	360AFX: 6.3:1   390AFX: 4.16:1   3120AFX: 3.12:1   3150AFX: 2.5:1			
Programming Resolution & Accuracy	0.01 Arms   $\pm 0.5\%$ of Full Scale			
Current Protection Modes	Constant Current (CC) or Output Trip (CV)			
Current Overload Mode	Allows 130% of max. RMS current for up to 2.0 secs before CP is triggered when enabled			
<b>OUTPUT PHASE ANGLES (FORM2 &amp; FORM3)</b>				
Phase Angle Range & Resolution	0.0° - 359.9°   0.1°			
<b>PROGRAMMABLE IMPEDANCE (Per unit, including parallel units)</b>				
Modes	Real-time mode, RMS mode			
Resistance (R)	1 Phase & 3 Phase:	$\pm 10 \Omega$	2 Phase:	$\pm 20 \Omega$
Inductance (L)	1 Phase & 3 Phase:	0 - 2 mH	2 Phase:	0 - 4 mH
<b>PROTECTIONS</b>				
Available Protection Settings	Over Current fold-back or trip   Prog. Peak Current Limit   Power fold-back or trip   App. Power fold-back or trip   Over Voltage trip   Over Temperature trip			
Over Voltage Protection Range	0 ~ 105% of voltage range			
AC Input Voltage	Over Voltage & Under Voltage, $\pm 15\%$ from Nominal			

### Footnotes:

1: Power restrictions apply below 15Hz and Voltage and Power restrictions apply above 1200Hz.

## Technical Specifications (continued)

PARAMETERS / FUNCTIONS		SPECIFICATIONS		
<b>MEASUREMENTS</b>		<b>Range</b>	<b>Resolution</b>	<b>Accuracy</b>
AC Voltage (Vrms)		0–350V <sub>LN</sub> /0–600V <sub>LL</sub> <sup>(2)</sup>	FP: 10 mV / Bus: 1 mV	± 0.25% F.S.
AC Current (Arms)		See Table page 9	FP: 10 mA / Bus: 1 mA	± 0.5% F.S. <sup>(3)</sup>
Current Crest Factor		1.00 - 5.00	FP: 0.01 / Bus: 0.001	± 2.0% F.S. <sup>(3)</sup>
Power (kW)		See Table page 9	FP: 1 W / Bus: 0.1 W	± 1.5% F.S. <sup>(4)</sup>
Apparent Power (kVA)		See Table page 9	FP: 1 VA / Bus: 0.1 VA	± 1.5% F.S. <sup>(4)</sup>
Power Factor		0.00 - 1.00 <sup>(4)</sup>	FP: 0.01 / Bus: 0.001	-
DC Voltage (Vdc)		0 – 440 Vdc <sup>(5)</sup>	FP: 10 mV / Bus: 1 mV	± 0.25% F.S.
DC Current (Idc)		See Table page 9	FP: 10mA / Bus: 1mA	± 0.5% F.S. <sup>(3)</sup>
<b>TRANSIENT FUNCTIONS</b>				
Programming	200 Steps / 400 Segments, LIST, PULSE & STEP Modes, Frequency, Volt AC, Volt DC, Waveform, Ramp Time, Dwell Time. Time range: 0.1 - 10000000.0 ms, Time resolution 0.2 ms			
Execution	Run from step # to step #, Run, Step, Restart, Stop			
Program Storage	Non-volatile, 100 Programs + Transients			
<b>ANALOG I/O</b> (DB25 Connector Rear Panel)				
Analog Inputs (4)	AI1, AI2, AI3:	Voltage A, B, C	AI4:	Frequency
Range, Accuracy, Impedance	0 - 10Vdc for 0 - F.S.	± 0.1% F.S.	10 kOhm	
Analog Outputs (4)	AO1, AO2, AO3:	Vmeas A, B, C	AO4:	Pmeas All Phases sum
Range, Accuracy, Impedance	0 - 10Vdc for 0 - F.S.	± 0.1% F.S. into 5kΩ	5 kOhm	
<b>DIGITAL I/O</b> (DB25 Connector Rear Panel)				
Digital Inputs - Fixed (3)	Remote Inhibit, Transient Trigger, Phase Sync			
Digital Inputs - User (3)	DI1, DI2, DI3, Functions are user defined			
Digital Outputs - Open Collector (2)	External Relay Control to change output FORM, Relay Control for T Option			
Digital Outputs - TTL, Fixed (2)	Output Relay / Transient / Function Strobe / Phase Sync			
Digital Outputs - TTL, User (2)	DO1, DO2			
Output Voltage Levels	Low < 0.4V, High > 4.6V			
<b>AC MAINS INPUT</b>				
Mains Voltage Input	4 Wire, L1, L2, L3 and PE			
Frequency	47 - 63 Hz			
Input Voltage Range	-2 models:	208 ~ 240Vac ±10%	-4 models:	380 ~ 480Vac ±10%
	<b>360AFX (6kW)</b>	<b>390AFX (9kW)</b>	<b>3120AFX (12kW)</b>	<b>3150AFX (15kW)</b>
Nominal Phase Current -2 @ 208V	23 Arms	33 Arms	43 Arms	51 Arms
Nominal Phase Current -4 @ 400V	13 Arms	18 Arms	24 Arms	27 Arms
Nominal Phase Current -4 @ 480V	11 Arms	14 Arms	20 Arms	23 Arms
Peak Inrush Current	< 1.5 x Irms			
Input Power Factor	> 0.9			
Efficiency	> 85%			

### Footnotes:



2: Voltage range is re-scaled as needed when T Option unit is connected

3: For RMS Currents above 2.0 A

4: For Power levels above 100 W

5: Range = 0 - 880 Vdc in Split phase mode

## Technical Specifications (continued)

PARAMETERS / FUNCTIONS		SPECIFICATIONS			
<b>REMOTE CONTROL INTERFACES</b>					
Standard Interfaces	USB Type B, LAN, GPIB / IEEE488, RS232, all on rear panel				
LAN / Ethernet Interface	LXI compliant, Ethernet, RJ45, TCP/IP Protocol, Telnet Protocol Command Line				
GPIB Functions	IEEE488,1, IEEE488.2 (2003 incl., NI HS488) IEC 60488-1, IEC 60488-2 (2004) Functions: SH1, AH1, T6, L3, SR1, RL1, DC1, DT1				
WIFI (Optional)	Optional external USB connected WIFI adapter available.				
ModBus TCP (Optional)	Uses Power Source's LAN interface to connect to CANopen Fieldbus				
CAN/CAN-FD (Optional)	Uses USB to CAN-FD adapter to connect to CAN network				
<b>ENVIRONMENTAL</b>					
Cooling	Variable speed fan cooled, front intake, rear exhaust				
Audible Noise @ 1 meter distance	Standby Mode:	46 dBA	Full Power:	85 dBA typical	
Energy Saving Modes	Standby Mode:	Output Stages OFF	Sleep Mode:	All power stages OFF	
Temperature	Operating:	0 to 40 °C 32 to 104 °F	Storage:	-20 to 70 °C -4 to 158 °F	
Humidity & Altitude	< 80%, non-condensing		2000 m / 6500 feet		
<b>MISC. SYSTEM FEATURES</b>					
Front Panel Display	Full Color, Touch LCD Display, 4.3" Diagonal size, 480 x 272 Pixels resolution				
USB Ports	2 on Front Panel, 1 on Rear Panel, All Type A				
SD Card	32 GB max. Capacity				
Video Output HDMI	Monitor Out, Front Panel				
<b>DIMENSIONS &amp; WEIGHTS</b>					
Chassis Size H x W x D <sup>(6)</sup>	7.0" x 17.0" x 25.0"		178 x 432 x 635 mm		
Shipping Package Size H x W x D	20" x 27" x 38"		508 x 686 x 965 mm		
Weight Single 4U Height Unit	Net:	111.2 lbs. / 50.4 kg	Shipping:	151 lbs / 68.5 kg	
<b>REGULATORY DATA</b>					
Safety	IEC 61010-1:2010 (Edition 3)				
EMC - Emissions	EN 55011:2009+A1:2010				
EMC - Immunity	EN 61000-4-2, EN 61000-4-3, EN 61000-4-4, EN 61000-4-5, EN 61000-4-6, EN 61000-4-8, EN 61000-4-11				
Product Category	EN 61326-1:2013 (Measurement, Laboratory and Control Equipment)				
Agency Approvals	CE Mark, NRTL Nemko US/Canada			 	
RoHS (DIRECTIVE 2011/65/EU)	Product Category EN50581:2012				

**Footnotes:**

6: Units can be zero-stacked in 19" EIA cabinet when using optional rack-slides. When using L-brackets, allow 1U space between units.



Model 360AFX - 6kVA/kW



Model 390AFX - 9kVA/kW



Model 3120AFX - 12kVA/kW



Model 3150AFX - 15kVA/kW



## Available Standard Model Configurations

AFX Series AC & DC Sources are available in several power levels. Models listed in the table below are rack mount or bench units. Cabinet systems are pre-wired for both input

and output power. For other configurations or power levels and cabinet options, contact factory. All models shown here require three phase AC input power.

MODEL	Phase Mode	Rated Power <sup>(1)</sup> AC / DC mode	Voltage Ranges <sup>(2)</sup> Vac L-N / Vdc	Max. AC/DC Current <sup>(2)</sup> 3 & 2 Phase Mode	Max. AC/DC Current <sup>(2)</sup> 1 Phase Mode <sup>(3)</sup>	Form Factor
<b>360AFX</b>	1, 2 & 3 Phase	6 kVA, kW / 6 kW	0-333 Vac / 0-425Vdc	16.7 Arms / 16.7 Adc	50 Arms / 50.0 Adc	4U Chassis
<b>390AFX</b>	1, 2 & 3 Phase	9 kVA, kW / 9 kW	0-333 Vac / 0-425Vdc	25.0 Arms / 21.0 Adc	75 Arms / 62.5 Adc	4U Chassis
<b>3120AFX</b>	1, 2 & 3 Phase	12 kVA, kW / 12 kW	0-333 Vac / 0-425Vdc	33.3 Arms / 21.0 Adc	100 Arms / 62.5 Adc	4U Chassis
<b>3150AFX</b>	1, 2 & 3 Phase	15 kVA, kW / 15 kW	0-333 Vac / 0-425Vdc	41.7 Arms / 21.0 Adc	125 Arms / 62.5 Adc	4U Chassis
<b>3180AFX</b>	1, 2 & 3 Phase	18 kVA, kW / 18 kW	0-333 Vac / 0-425Vdc	50.0 Arms / 41.7 Adc	150 Arms / 125.0 Adc	18U Cabinet
<b>3240AFX</b>	1, 2 & 3 Phase	24 kVA, kW / 24 kW	0-333 Vac / 0-425Vdc	66.7 Arms / 41.7 Adc	200 Arms / 125.0 Adc	18U Cabinet
<b>3300AFX</b>	1, 2 & 3 Phase	30 kVA, kW / 30 kW	0-333 Vac / 0-425Vdc	83.3 Arms / 41.7 Adc	250 Arms / 125.0 Adc	18U Cabinet
<b>3450AFX</b>	1, 2 & 3 Phase	45 kVA, kW / 45 kW	0-333 Vac / 0-425Vdc	125.0 Arms / 62.5 Adc	375 Arms / 187.5 Adc	18U Cabinet
<b>3600AFX</b>	1, 2 & 3 Phase	60 kVA, kW / 60 kW	0-333 Vac / 0-425Vdc	166.7 Arms / 83.3 Adc	500 Arms / 250.0 Adc	28U Cabinet
<b>3750AFX</b>	1, 2 & 3 Phase	75 kVA, kW / 75 kW	0-333 Vac / 0-425Vdc	208.3 Arms / 104 Adc	625 Arms <sup>3</sup> / 312.5 Adc	28U Cabinet
<b>3900AFX</b>	1, 2 & 3 Phase	90 kVA, kW / 90 kW	0-333 Vac / 0-425Vdc	250.0 Arms / 125 Adc	750 Arms <sup>3</sup> / 375.0 Adc	28U Cabinet
<b>Higher</b>	For configurations up to 180kVA/kW, contact factory					

Note 1: Rated power shown is for Three Phase or Single Phase mode operation. For Split Phase mode, rated power is 2/3.

Note 2: Extended Voltage Range Limit. Rated Currents are full specification, nominal values. See specification section for extended operating voltage ranges.

Note 3: Contact factory for cabinet output wiring modifications to support single phase AC mode on cabinets above 60kVA.

## Unit Dimensions<sup>(4)</sup>

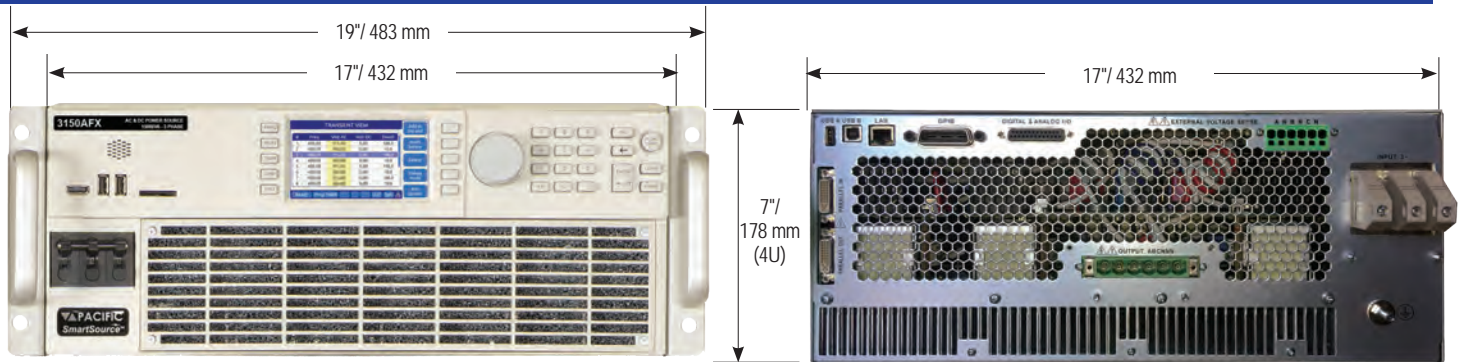

The 3150AFX is designed for bench top or 19" equipment rack operation. Shown with included rack mount handles.

The AFX Rear Panel provides connections for AC Input, AC or DC Output, External Sense, Aux I/O and remote control interfaces. Shown with standard GPIB Interface

Note 4: Units can be zero-stacked in 19" EIA cabinet when using optional rack-slides. When using L-brackets, allow for some space between units.

### Safety Cover & Strain Relief Kit Option

An optional Safety Cover and Strain Relief Kit is available. This kit includes covers for AC input connections and AC&DC Output connections. Both covers include wire strain reliefs to prevent accidental release of input or output wiring. This kit is easily installed on the rear panel of the AC Power Source using existing mounting studs. Available for either three phase output configuration or single phase output configuration.

**Note** that AC input and AC output wiring of adequate gauge and current rating is NOT included in this kit and is to be provided by the end-user or system integrator.



# Ordering Information

## Standard Models and Cabinet Systems (Refer to Model Number Encoder below)

<b>Bench Models</b> <input type="checkbox"/> 360AFX <input type="checkbox"/> 390AFX <input type="checkbox"/> 3120AFX <input type="checkbox"/> 3150AFX	<b>Cabinet Systems<sup>1</sup></b> <input type="checkbox"/> 3180AFX <input type="checkbox"/> 3600AFX <input type="checkbox"/> 3240AFX <input type="checkbox"/> 3750AFX <input type="checkbox"/> 3300AFX <input type="checkbox"/> 3900AFX <input type="checkbox"/> 3450AFX Systems available up to 180kVA	<b>Alternate Voltage Range Options</b> <input type="checkbox"/> S Suffix - 600V Series Output Requires pairs of AFX units <input type="checkbox"/> T Suffix - 400V Transformer Option Consult factory for other voltage ranges	<b>Master Unit with front panel controller</b> <input type="checkbox"/> A Controller w/Analog & Digital I/O <input type="checkbox"/> G GPIB Interface
<b>Auxiliary Models (No controller)</b> <input type="checkbox"/> 390AFX-2NC / 390AFX-4NC <input type="checkbox"/> 3120AFX-2NC / 3120AFX-4NC <input type="checkbox"/> 3150AFX-2NC / 3150AFX-4NC	<b>Input Voltage (V<sub>IN</sub>)</b> <input type="checkbox"/> -2 208V - 240Vac, 3Ø ± 10%, 47-63Hz <input type="checkbox"/> -4 380V - 480Vac, 3Ø ± 10%, 47-63Hz		<b>Options</b> <input type="checkbox"/> B For use with ECTS2 Test Systems <input type="checkbox"/> C IEC413 Interharmonics Generator <input type="checkbox"/> DM Dual Master (45kVA or higher models only) <input type="checkbox"/> O OCS Output Control Switch <input type="checkbox"/> W Wiring Isolated Output Neutrals
<b>Export Version</b> <input type="checkbox"/> E Append "E" postfix			

### AFX Series Model Number Encoder:

Note: Solid outlined fields must be specified. Dashed outlined fields are optional.

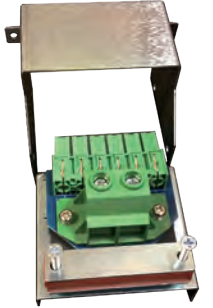
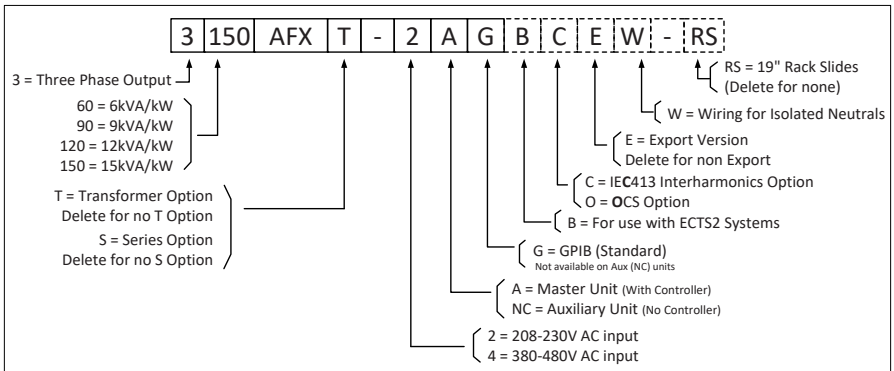

Single Phase Mode Output Adapter Option

### Order Example

- 3150AFX-2AG
- Bench Model, 15 kVA, 3-Phase, AC Power Source with USB, RS232, LAN, GPIB & AUX I/O
  - 208Vac 3 Phase Input Voltage

### Typical Delivery Items

- AC & DC Power Source
- English Manuals in PDF Format
- Rack Mount Handles
- Certificate of Compliance

### Available Accessories

- Output shorting adapter for single phase output mode use. P/N 160086 (see pic.)
- Paralleling Cable, 1 Ft. (Included with Aux models). P/N 778036
- Rack slides. P/N 703251

Note 1: Cabinet systems consist of one master unit and one or more auxiliary units integrated into a 19 inch EIA instrument grade cabinet. Includes input and output wiring to rear mounted compression terminal blocks. Shown with optional Emergency Power Off (EPO). Other cabinet options available. Customers that require the use of their own cabinets can order system kits without cabinet. Contact factory for ordering information.

## Software Options

<b>Windows 10 Software</b> <input type="checkbox"/> PPSC Test Manager Windows Software	<b>Test Sequences - Avionics<sup>(2)</sup></b> <input type="checkbox"/> ABD0100.1.8 - Airbus A380, AC & DC Power Groups <input type="checkbox"/> ABD0100.1.8.1 - Airbus A350, AC & DC Power Groups <input type="checkbox"/> AMD24C - Airbus A400M, AC & DC Power Groups <input type="checkbox"/> Boeing 787B3-0147 - B787, AC & DC Power Groups <input type="checkbox"/> MIL-STD704 - US DoD, AC & DC Power Groups <input type="checkbox"/> RTCA-DO160 Section 16, AC & DC Power Groups	<b>Test Sequences - Other<sup>(2)</sup></b> <input type="checkbox"/> IEC Test Suite - Includes IEC 61000-4-11p, IEC 61000-4-14, IEC 61000-4-27p, IEC 61000-4-28, IEC 61000-4-29p and IEC 61000-4-34 <input type="checkbox"/> MIL-STD 1399-300B - US DoD, Ship-board Power, AC Power Groups
---	---	--

Note 2: Test Sequence Options require use of the standard Web Browser Interface via LAN or USB or PPSC Test Manager Windows Software

Proudly Represented by:

2802 Kelvin Avenue, Suite 100  
 Irvine, CA 92614 -5897 USA  
 Phone: +1 949.251.1800  
 Fax: +1 949.756.0756  
 Toll Free: 800.854.2433  
 E-mail: sales@pacificpower.com  
 Web: www.pacificpower.com