

## Operation Manual

5P SERIES – Rev 1.4 P/N 160909-10

---

# 5P Series Cabinet Programmable DC Load

---



## ADAPTIVE Power Systems

Worldwide Supplier of Power Equipment

Copyright © 2014, Adaptive Power Systems, Inc. (APS) • All Rights Reserved • No reproduction without written authorization from APS.

PAGE LEFT INTENTIONALLY LEFT BLANK FOR HARDCOPY VERSIONS OF THIS DOCUMENT



## Table of Contents

<b>1</b>	<b>Contact Information .....</b>	<b>9</b>
<b>2</b>	<b>Front Matter .....</b>	<b>10</b>
2.1	Limited Warranty .....	10
2.2	Service and Spare Parts Limited Warranty .....	10
2.3	Safety Information.....	10
2.4	Safety Notices .....	12
<b>3</b>	<b>Product Overview .....</b>	<b>14</b>
3.1	General Description.....	14
3.2	Operating Modes .....	14
3.2.1	Constant Current Mode .....	14
3.2.2	Constant Resistance Mode .....	15
3.2.3	Constant Voltage Mode .....	15
3.2.4	Constant Power Mode .....	15
3.3	Static versus Dynamic Operating Modes .....	16
3.3.1	Programmable Parameters.....	16
3.3.2	Slew Rates .....	17
3.3.3	Determining Actual Transition Times .....	18
3.4	Current Read-back.....	19
3.5	Analog Input Mode .....	19
3.6	Product Features .....	19
3.7	Accessories Included .....	20
3.8	Interface Options.....	20
3.9	Load Cable Options .....	20
<b>4</b>	<b>Technical Specifications .....</b>	<b>21</b>
4.1	Operating Ranges .....	21
4.2	Operating Modes .....	22
4.3	Protection Modes.....	23
4.4	Dynamic Operation Mode .....	23
4.5	Metering .....	24
4.6	Miscellaneous .....	25
4.7	AC Input & Cooling .....	25
4.8	Dimensions & Weight .....	25
4.9	Environmental .....	30
4.10	Voltage versus Current Operating Envelope Charts.....	31
4.10.1	Model 5P024-24 V-I Curves .....	32
4.10.2	Model 5P024-48 V-I Curves .....	33
4.10.3	Model 5P036-24 V-I Curves .....	34
4.10.4	Model 5P036-48 V-I Curves .....	35
4.10.5	Model 5P036-72 V-I Curves .....	36
4.10.6	Model 5P054-36 V-I Curves .....	37
4.10.7	Model 5P054-72 V-I Curves .....	38
4.10.8	Model 5P054-99 V-I Curves .....	39
4.10.9	Model 5P072-48 V-I Curves .....	40
4.10.10	Model 5P072-96 V-I Curves .....	41
4.10.11	Model 5P090-60 V-I Curves .....	42
4.10.12	Model 5P0108-72 V-I Curves .....	43
4.10.13	Model 5P126-84 V-I Curves .....	44
4.10.14	Model 5P144-96 V-I Curves .....	45
<b>5</b>	<b>Unpacking and Installation .....</b>	<b>46</b>

5.1	Inspection .....	46
5.2	Check Line Voltage .....	46
5.3	Input Fuse .....	47
5.3.1	Fuse Replacement Procedure .....	48
5.4	Grounding Requirements .....	48
5.5	Chassis Position .....	49
5.6	Rack Mounting.....	49
5.7	Cleaning.....	49
5.8	Powering Up .....	49
5.9	In Case of Malfunction .....	50
5.10	Load Connection.....	50
5.11	Interface Options.....	52
5.11.1	RS232 Serial Interface.....	52
5.11.2	GPIB Interface .....	52
5.11.3	USB Interface .....	53
5.11.4	LAN Interface .....	53
5.11.5	GPIB & RS232 Combination Interface .....	53
5.12	Analog Programming Input.....	54
5.13	Load Current Slew Rate.....	55
<b>6</b>	<b>Front Panel Operation .....</b>	<b>57</b>
6.1	Front Panel Layout .....	57
6.2	User Controls and Readouts .....	58
6.3	Shuttle Adjustment Resolution by Model.....	68
6.3.1	Model 5P024-24 Shuttle Knob Adjustments .....	68
6.3.2	Model 5P024-48 Shuttle Knob Adjustments .....	68
6.3.3	Model 5P036-24 Shuttle Knob Adjustments .....	70
6.3.4	Model 5P036-48 Shuttle Knob Adjustments .....	70
6.3.5	Model 5P036-72 Shuttle Knob Adjustments .....	70
6.3.6	Model 5P054-36 Shuttle Knob Adjustments .....	71
6.3.7	Model 5P054-99 Shuttle Knob Adjustments .....	71
6.3.8	Model 5P072-48 Shuttle Knob Adjustments .....	71
6.3.9	Model 5P072-96 Shuttle Knob Adjustments .....	72
6.3.10	Model 5P090-60 Shuttle Knob Adjustments .....	72
6.3.11	Model 5P108-72 Shuttle Knob Adjustments .....	72
6.3.12	Model 5P126-84 Shuttle Knob Adjustments .....	73
6.3.13	Model 5P144-96 Shuttle Knob Adjustments .....	73
6.4	Bottom LCD Display.....	74
6.5	Bottom Keypad Description.....	76
6.6	Setting System Parameters.....	77
6.7	Settings STORE/RECALL Operation.....	79
6.7.1	Storing a Load Setup.....	79
6.7.2	Recalling a Load Setup.....	79
6.8	WAKE-UP Function .....	80
6.9	AUTO-SEQUENCING .....	81
6.9.1	AUTO-SEQUENCE – EDIT MODE .....	81
6.9.2	AUTO-SEQUENCE – TEST MODE.....	84
6.10	Initial Power-on Settings .....	87
6.10.1	Model 5P024-24 Power-on Settings.....	87
6.10.2	Model 5P024-48 Initial Settings.....	87
6.10.3	Model 5P036-24 Power-on Settings.....	88
6.10.4	Model 5P036-48 Initial Settings.....	88
6.10.5	Model 5P036-72 Power-on Settings.....	89

6.10.6	Model 5P054-36 Initial Settings.....	89
6.10.7	Model 5P054-72 Power-on Settings.....	90
6.10.8	Model 5P054-99 Initial Settings.....	90
6.10.9	Model 5P072-48 Power-on Settings.....	91
6.10.10	Model 5P072-96 Initial Settings.....	91
6.10.11	Model 5P090-60 Power-on Settings.....	92
6.10.12	Model 5P108-72 Initial Settings.....	92
6.10.13	Model 5P126-84 Power-on Settings.....	93
6.10.14	Model 5P144-96 Initial Settings.....	93
<b>7</b>	<b>Rear Panel Overview, Connectors and Protection Features.....</b>	<b>94</b>
7.1	DC INPUT Terminals .....	94
7.1.1	Wire Size.....	94
7.1.2	Connecting a UUT.....	94
7.1.3	Polarity and Ground .....	95
7.2	Voltage Sense Input Terminals .....	95
7.3	Current Output Monitor (I-Monitor).....	96
7.3.1	Non-Isolated Output .....	96
7.3.2	Output Impedance .....	97
7.3.3	Connecting I-Monitor Output to an Oscilloscope.....	98
7.4	Parallel Operation.....	99
7.4.1	Parallel Mode Connection.....	99
7.4.2	Allowable Operating Modes .....	99
7.4.3	Exceptions .....	99
7.5	Series Operation .....	99
7.6	Zero-Voltage Loading .....	100
7.7	Protection Features.....	101
7.7.1	Over Voltage Protection.....	101
7.7.2	Over Current Protection.....	101
7.7.3	Over Power Protection.....	101
7.7.4	Over Temperature Protection .....	102
7.7.5	Reverse Polarity Protection Indication .....	102
<b>8</b>	<b>Remote Control Programming.....</b>	<b>103</b>
8.1	Overview .....	103
8.2	RS232 Set-up.....	104
8.3	Programming Syntax.....	105
8.3.1	Parenthesis.....	105
8.3.2	Terminators.....	106
8.4	Short Form Command Syntax.....	107
8.4.1	Notations and Conventions Used in programming commands: .....	110
8.5	Long Form Command Syntax.....	111
8.6	Remote Control Command Descriptions .....	115
8.6.1	SETTING Commands.....	116
8.6.2	LIMIT Commands.....	125
8.6.3	STATE Commands.....	128
8.6.4	SYSTEM Commands .....	134
8.6.5	MEASUREMENT Commands.....	137
8.7	IEEE488.2 Common Commands.....	138
8.7.1	*IDN?.....	138
8.7.2	*RST.....	138
<b>9</b>	<b>USB Driver Installation.....</b>	<b>139</b>
9.1	Overview .....	139
9.2	USB Driver Installation .....	139

---

<b>10 LAN Driver Installation.....</b>	<b>142</b>
10.1 Overview .....	142
10.2 Factory Default IP Address Setting .....	142
10.3 Download IP Scanner Utility Program File .....	143
10.4 LAN Setup .....	144
10.5 Setting a static IP address on Windows 10 PC .....	146
<b>11 Auto Sequence Programming Examples .....</b>	<b>150</b>
11.1 Overview .....	150
11.2 Edit Mode .....	150
11.3 Test Mode .....	151
11.4 AUTO TEST SEQUENCE Example .....	152
<b>12 Short Circuit, OPP and OCP Test Examples .....</b>	<b>154</b>
12.1 Overview .....	154
12.2 SHORT Test .....	154
12.3 OPP Test.....	155
12.4 OCP Test.....	156
<b>13 CE MARK Declaration of Conformity.....</b>	<b>157</b>
<b>14 RoHS Material Content Declaration.....</b>	<b>158</b>
<b>Index .....</b>	<b>159</b>

## Table of Tables

Table 3-1: Dynamic Current Mode Parameters.....	16
Table 3-2: Included Accessories .....	20
Table 3-3: Available Remote Control Interface Options.....	20
Table 3-4: Available Load Cable Options .....	20
Table 6-1: Front Panel Display and Keyboard Functions .....	68
Table 6-2: Memory Bank LCD Display and Selection Keys .....	75
Table 6-3: Memory Bank Control Keypad.....	76
Table 6-4: Model 5P024-24 Power-on Settings.....	87
Table 6-5: Model 5P024-48 Power-on Settings.....	87
Table 6-6: Model 5P036-24 Power-on Settings.....	88
Table 6-7: Model 5P036-48 Power-on Settings.....	88
Table 6-8: Model 5P036-72 Power-on Settings.....	89
Table 6-9: Model 5P054-36 Power-on Settings.....	89
Table 6-10: Model 5P054-72 Power-on Settings.....	90
Table 6-11: Model 5P054-99 Power-on Settings.....	90
Table 6-12: Model 5P024-24 Power-on Settings.....	91
Table 6-13: Model 5P024-48 Power-on Settings.....	91
Table 6-14: Model 5P090-60 Power-on Settings.....	92
Table 6-15: Model 5P108-72 Power-on Settings.....	92
Table 6-16: Model 5P126-84 Power-on Settings.....	93
Table 6-17: Model 5P144-96 Power-on Settings.....	93
Table 8-1: RS232 DB9 Pin Assignments .....	104
Table 8-2: Supported Command Terminators .....	106
Table 8-3: Setting Commands - Short Form .....	107
Table 8-4: Query Commands - Short Form .....	108
Table 8-5: Limit Commands - Short Form .....	108
Table 8-6: Test Commands - Short Form .....	109
Table 8-7: System Commands - Short Form .....	109
Table 8-8: Measurement Query Commands - Short Form .....	110
Table 8-9: Auto Sequence Commands - Short Form .....	110
Table 8-10: Setting Commands - Long Form .....	111
Table 8-11: Query Commands - Long Form.....	112
Table 8-12: Limit Commands - Long Form.....	112
Table 8-13: State Commands - Long Form .....	113
Table 8-14: System Commands - Long Form .....	113
Table 8-15: Measurement Query Commands .....	114
Table 8-16: Auto Sequence Commands - Long Form .....	114
Table 8-17: Error Register Bits.....	131
Table 8-18: Protection Status Register Bits .....	132
Table 8-19: 5P Series Load Model Name Return Values .....	135
Table 11-1: Auto-Test Sequence Example Values .....	152

## Table of Figures

Figure 3-1: Dynamic Current Wave Form .....	16
Figure 3-2: Rise Time Performance Limits .....	17
Figure 4-1: 5P Series Cabinet Layout – Front View (original dimensions) .....	27
Figure 4-2: 5P Series Cabinet Layout – Front View .....	28
Figure 4-3: 5P Series Cabinet Layout - Rear View .....	29
Figure 4-1: Model 5L18-36 VI Curve .....	46
Figure 5-2: AC Input Voltage Selection .....	46
Figure 5-3: Fuse Holder Location .....	48
Figure 5-4: RS232 Connection .....	52
Figure 5-5: GPIB Connection .....	52
Figure 5-6: USB Connection .....	53
Figure 5-7 LAN Connection .....	53
Figure 5-8: RS232 Connection .....	53
Figure 5-9: Location and Pin-out of Analog Programming Input Connector on 5P Master Unit .....	54
Figure 5-10: Analog Programming Example .....	54
Figure 5-11: Effect of Current Slew Rate Settings on Power Supply Testing .....	56
Figure 6-1: 5P Series DC Load Front Panel View .....	57
Figure 6-2: Front Panel User Controls and Indicators .....	58
Figure 6-3 Auto Sequence Edit Mode Procedure Flow Chart .....	83
Figure 7-1: DC Load Connection with External Voltage Sense .....	95
Figure 7-2: Equivalent I-Monitor Output Circuit .....	97
Figure 7-3: Correct I-Monitor Connections to UUT and Oscilloscope .....	98
Figure 7-4: Incorrect I-Monitor Connections to UUT and Oscilloscope .....	98
Figure 7-5: Parallel Load Connection .....	99
Figure 7-6: Zero Volt Load Connection .....	100
Figure 8-1: RS232 Connection to PC and DB9 Pin out .....	104
Figure 11-1: LAN IP Scanner Utility Program Download .....	143
Figure 11-1 Auto-Test Sequence Example Illustration .....	152



## 1 Contact Information

### AMERICA / CANADA

Adaptive Power Systems  
Irvine, USA  
Phone: +1(949) 752-8400  
Fax: +1 (949) 756-0838  
Email: [support@adaptivepower.com](mailto:support@adaptivepower.com)

### EUROPE

Caltest Instruments Ltd.  
Guildford, United Kingdom  
Phone: +44(0)1483 302 700  
Fax: +44(0)1483 300 562  
Email: [support@adaptivepower.com](mailto:support@adaptivepower.com)

### CHINA

PPST Shanghai Co. Ltd.  
Shanghai, China  
Phone: +86-21-6763-9223  
Fax: +86-21-5763-8240  
Email: [support@adaptivepower.com](mailto:support@adaptivepower.com)

Web: <http://www.adaptivepower.com>

## 2 Front Matter

### 2.1 Limited Warranty

Adaptive Power Systems, Inc. (APS) warrants each unit to be free from defects in material and workmanship. For the period of one (1) year from the date of shipment to the purchaser, APS will either repair or replace, at its sole discretion, any unit returned to the APS factory in Irvine, California or one of its designated service facilities. It does not cover damage arising from misuse of the unit or attempted field modifications or repairs. This warranty specifically excludes damage to other equipment connected to this unit.

Upon notice from the purchaser within (30) days of shipment of units found to be defective in material or workmanship, APS will pay all shipping charges for the repair or replacement. If notice is received more than thirty (30) days from shipment, all shipping charges shall be paid by the purchaser. Units returned on debit memos will not be accepted and will be returned without repair.

**This warranty is exclusive of all other warranties, expressed or implied.**

### 2.2 Service and Spare Parts Limited Warranty

APS warrants repair work to be free from defects in material and workmanship for the period of ninety (90) days from the invoice date. This Service and Spare Parts Limited Warranty applies to replacement parts or to subassemblies only. All shipping and packaging charges are the sole responsibility of the buyer. APS will not accept debit memos for returned power sources or for subassemblies. Debit memos will cause return of power sources or assemblies without repair.

**This warranty is exclusive of all other warranties, expressed or implied.**

### 2.3 Safety Information

This chapter contains important information you should read BEFORE attempting to install and power-up APS Equipment. The information in this chapter is provided for use by experienced operators. Experienced operators understand the necessity of becoming familiar with, and then observing, life-critical safety and installation issues. Topics in this chapter include:

- Safety Notices
- Warnings
- Cautions
- Preparation for Installation
- Installation Instructions



Make sure to familiarize yourself with the **SAFETY SYMBOLS** shown on the next page. These symbols are used throughout this manual and relate to important safety information and issues affecting the end user or operator.

### SAFETY SYMBOLS



Direct current (DC)



Alternating current (AC)



Both direct and alternating current



Three-phase alternating current



Protective Earth (ground) terminal



On (Supply)



Off (Supply)

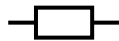

Fuse



Caution: Refer to this manual before this Product.



Caution, risk of electric shock

## 2.4 Safety Notices

### **SAFETY SUMMARY**

The following general safety precautions must be observed during all phases of operation, service, and repair of this instrument. Failure to comply with these precautions or with specific warnings elsewhere in this manual violates safety standards of design, manufacture, and intended use of the instrument. Adaptive Power Systems assumes no liability for the customer's failure to comply with these requirements.

### **GENERAL**

This product is a Safety Class 1 instrument (provided with a protective earth terminal). The protective features of this product may be impaired if it is used in a manner not specified in the operation instructions.

### **ENVIRONMENTAL CONDITIONS**

This instrument is intended for indoor use in an installation category I, pollution degree 2 environments. It is designed to operate at a maximum relative humidity of 80% and at altitudes of up to 2000 meters. Refer to the specifications tables for the ac mains voltage requirements and ambient operating temperature range.

### **BEFORE APPLYING POWER**

Verify that the product is set to match the available line voltage and the correct fuse is installed.

### **GROUND THE INSTRUMENT**

This product is a Safety Class 1 instrument (provided with a protective earth terminal). To minimize shock hazard, the instrument chassis and cabinet must be connected to an electrical ground. The instrument must be connected to the AC power supply mains through a properly rated three-conductor power cable, with the third wire firmly connected to an electrical ground (safety ground) at the power outlet. Any interruption of the protective (grounding) conductor or disconnection of the protective earth terminal will cause a potential shock hazard that could result in personal injury.

### **FUSES**

Only fuses with the required rated current, voltage, and specified type (normal blow, time delay, etc.) should be used. Do not use repaired Fuses or short circuit the fuse holder. To do so could cause a shock or fire hazard.

### **DO NOT OPERATE IN AN EXPLOSIVE ATMOSPHERE.**

Do not operate the instrument in the presence of flammable gases or fumes.

### **KEEP AWAY FROM LIVE CIRCUITS.**

Operating personnel must not remove instrument covers. Component replacement and internal adjustments must be made by qualified service personnel. Do not replace components with power cable connected. Under certain conditions, dangerous voltages

may exist even with the power cable removed. To avoid injuries, always disconnect power, discharge circuits and remove external voltage sources before touching components.

**DO NOT SERVICE OR ADJUST ALONE.**

Do not attempt internal service or adjustment unless another person, capable of rendering first aid and resuscitation, is present.

**DO NOT EXCEED INPUT RATINGS.**

This instrument may be equipped with a line filter to reduce electromagnetic interference and must be connected to a properly grounded receptacle to minimize electric shock hazard. Operation at line voltages or frequencies in excess of those stated on the data plate may cause leakage currents in excess of 5.0 mA peak.

**DO NOT EXCEED LOAD INPUT VOLTAGE RATING.**

 **WARNING**

**DO NOT EXCEED LOAD INPUT VOLTAGE RATING**

This instrument does **NOT** have a means to disconnect its Load input from a connected power supply. If the voltage applied to the Load input exceeds its maximum rating – even if the load is turned completely off – damage to the load **WILL** occur. Damage caused by exceeded maximum load input voltage under any circumstance is **NOT** covered by the manufacturer’s product warranty. Remove any load input connections when the load is not in use, even when it is turned off.

**DO NOT SUBSTITUTE PARTS OR MODIFY INSTRUMENT.**

Because of the danger of introducing additional hazards, do not install substitute parts or perform any unauthorized modification to the instrument. Return the instrument to an Adaptive Power Systems Sales and Service Office for service and repair to ensure that safety features are maintained.

Instruments that appear damaged or defective should be made inoperative and secured against unintended operation until they can be repaired by qualified service personnel.

## 3 Product Overview

This chapter provides an overview of the APS 5P Series Programmable DC loads. It introduces the reader to general operating characteristics of these loads.

### 3.1 General Description

The APS 5P Series electronic load is designed to test, evaluation and burn-in DC power supplies and batteries. The APS 5P Series electronic loads consist of two or more 19" rack mount loads connected in a parallel configuration to obtain the desired load capacity. Of these units, one acts as the master and controls one or more slave units. Slave units have no front panel controls. The 5P Series load can be operated from the master's front panel (manual mode) or using RS232, USB, LAN (Ethernet) or GPIB remote control.

The VI curve constant power contours of the various 5P Series models are shown in the Technical Specification Section. All models have dual voltage range capability of 0 to 6.0Vdc and 0 to 60.0Vdc. Maximum current and power capability depends on the specific model.

### 3.2 Operating Modes

Available operating modes for all models are:

- Constant Current (CC) mode
- Constant Resistance (CR) mode
- Constant Voltage (CV) mode
- Constant Power (CP) mode.

A more detailed explanation of each mode and under what condition each mode is most appropriate to use follows.

#### 3.2.1 Constant Current Mode

This is the most commonly used mode of operating when testing a voltage source such as a DC power supply, battery, AC/DC converter or ADC. In this mode of operation, the load will sink a constant level of current as set by the user, regardless of any voltage variations. A real time feedback loop ensures a stable current under any voltage variation of the DC supply or battery.

This mode is recommended for load regulation testing, loop stability testing, battery discharge testing and any other form of voltage regulation loop testing.

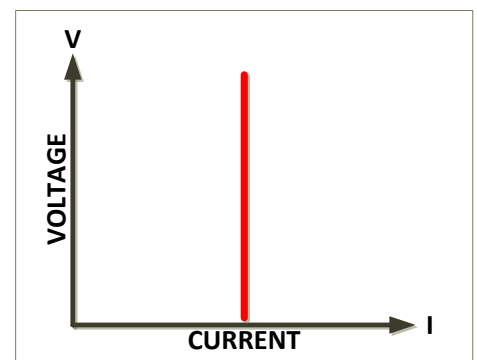

### 3.2.2 Constant Resistance Mode

In Constant Resistance mode, the load will sink current directly proportional to the sensed DC input voltage. The ratio between DC voltage and current is linear per ohms law and can be set by the user within the operating range of the DC load. The current is defined by the formula shown here where R is the set value in CR mode and V is the dc input voltage from the unit under test.

$$I = V/R$$

CR mode is useful for battery discharge testing of battery systems used to power constant impedance loads as the voltage will decrease as the battery discharges over time resulting in reduced current sinking.

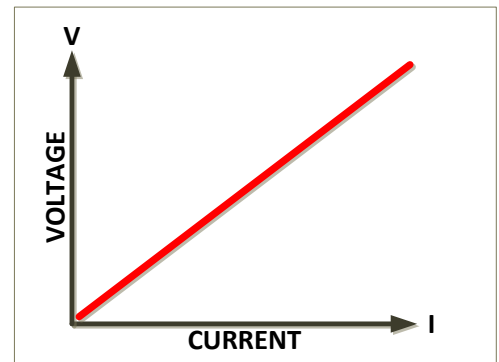

### 3.2.3 Constant Voltage Mode

In Constant Voltage mode, the load will attempt to sink as much current as needed to reach the programmed voltage setting. This mode should only be used with current controlled DC power sources.

**Note:** Most DC power supplies are voltage controlled, i.e. they regulate the output voltage to a predefined voltage level. Such DC voltage supplies should not be tested using CV mode as the DC supply voltage regulation loop will conflict with the DC load control loop.

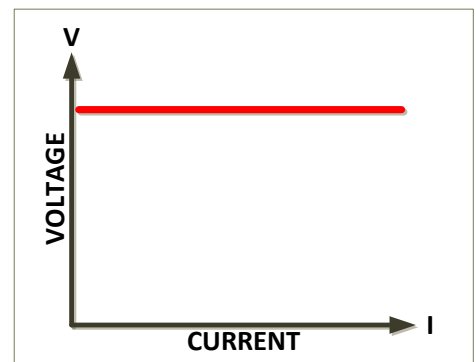

### 3.2.4 Constant Power Mode

In Constant Power mode, the DC load will attempt to maintain the programmed Power dissipation by sinking more or less current at the voltage sensed. The current is defined by the formula shown below.

$$I = P/V$$

Constant power mode is useful for battery discharge testing as it simulates constant power drain on the battery, regardless of battery charge state.

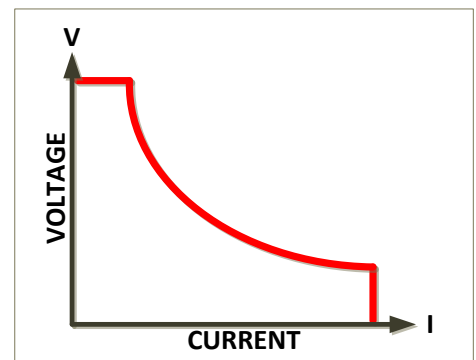

### 3.3 Static versus Dynamic Operating Modes

The 5P Series supports both STATIC and DYNAMIC CC mode. Static mode uses a constant load level whereas dynamic mode allows rapid changes between two pre-set current sink levels using programmable current slew rates and duty cycle.

Static Constant Current mode presents a static load condition as the load current remains constant. This tests load regulation of a DC power supply under steady state operating conditions.

To test voltage regulation under dynamic load conditions, specific changes in current level and current slew rates must be applied to the DC supply under test. The dynamic CC mode is provided for this application.

The 5P Series offers a wide range of dynamic load conditions with independent rise and fall current slew rate programming in Constant Current mode.

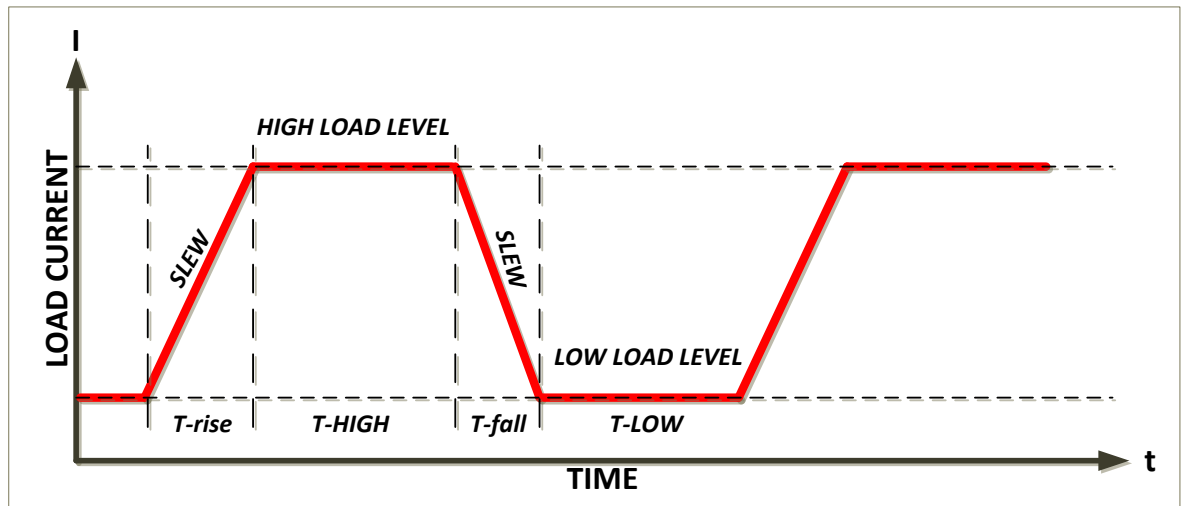

Figure 3-1: Dynamic Current Wave Form

#### 3.3.1 Programmable Parameters

There are six programmable parameters to generate a dynamic waveform or pulse waveform. The 5P Series load will sink current from a power source proportional to the dynamic wave form. The dynamic wave form definition is shown in Figure 3-1. Available settings are:

Parameter	Description	Type
<b>Current High</b>	Highest programmed load current	Current Setting
<b>Current Low</b>	Lowest programmed load current	Current Setting
<b>T-High</b>	Duration at High current setting	Time (secs)
<b>T-Low</b>	Duration at Low current setting	Time (secs)
<b>Rising Slew Rate</b>	Current Slew Rate from Low to High Current	A/sec
<b>Falling Slew Rate</b>	Current Slew Rate from High to Low Current	A/sec

Table 3-1: Dynamic Current Mode Parameters



The resulting Current Waveform has the following characteristics:

$$\text{Period} = T\text{-High} + T\text{-Low}$$

$$\text{Frequency} = 1 / ( T\text{-High} + T\text{-Low} )$$

$$\text{Duty Cycle} = T\text{-High} / ( T\text{-High} + T\text{-Low} )$$

### 3.3.2 Slew Rates

Slew rate is defined as the change in current or voltage over time. A programmable slew rate allows a controlled transition from one load setting to another to minimize induced voltage drops on inductive power wiring, or to control induced transients on a test device (such as would occur during power supply transient response testing).

In cases where the transition from one setting to another is large, the actual transition time can be calculated by dividing the voltage or current transition by the slew rate. The actual transition time is defined as the time required for the input to change from 10% to 90% or from 90% to 10% of the programmed current excursion. In cases where the transition from one setting to another is small, the small signal bandwidth of the load limits the minimum transition time for all programmable slew rates. Because of this limitation, the actual transition time is typically longer than the expected time based on the slew rate setting, as shown in Figure 3-2.

Therefore, both minimum transition time and slew rate must be considered when determining the actual transition time. *See also section 5.13 "Load Current Slew Rate" on page 55.*

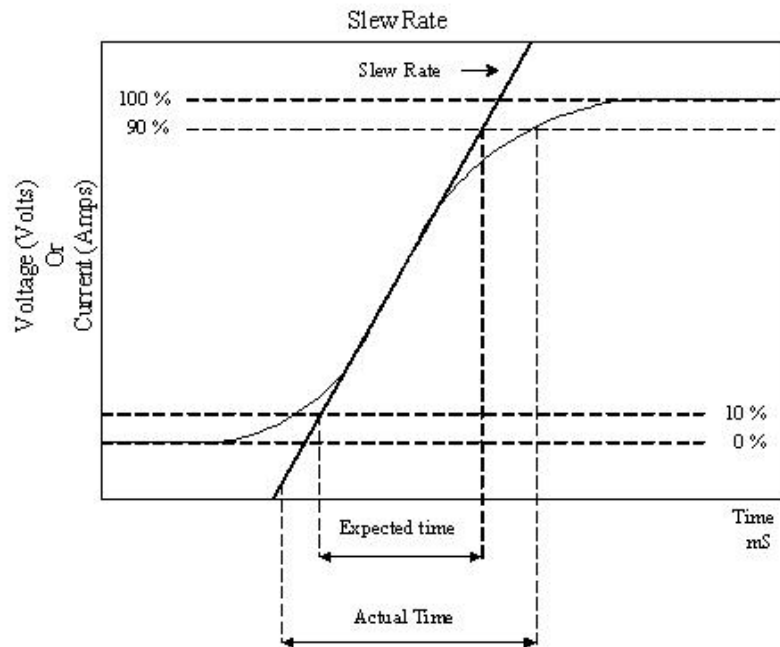

Figure 3-2: Rise Time Performance Limits

### 3.3.3 Determining Actual Transition Times

The minimum transition time ( $Tr_{min}$ ) for a given slew rate applies for smaller changes in current as a percent of current range. At about a 30% or greater load change, the slew rate starts to increase from the minimum transition time to the maximum transition time ( $Tr_{max}$ ) at a 100% load change. The actual transition time will be either the minimum transition time, or the total slew time (T-fall or T-rise) divided by the current slew rate, whichever is longer.

#### Minimum $Tr$

Use the following formulas to calculate the minimum transition time for a given slew rate:

$$Tr_{min} = \frac{72}{\text{slew rate (A/us)}} * \frac{(90\% - 10\%)}{100\%} \mu\text{s}$$

Which is equivalent to:

$$Tr_{min} = \frac{72}{\text{slew rate (A/us)}} * 0.8 \mu\text{s}$$

For a slew rate of 10A/ $\mu\text{s}$ , this results in:

$$Tr_{min} = \frac{72}{10} * 0.8 \mu\text{s} = 5.76 \mu\text{s}$$

#### Example 1:

Assume high current level C-high = 48A and low current level C-low = 0A. Assume 48A represents less than 30% of full scale current for the DC load model used. If the slew rate is set to 10A/ $\mu\text{s}$ , the expected transition time would be:

$$Tr = \frac{0.8 * (48 - 0)}{10} \mu\text{s} = 3.84 \mu\text{s}$$

However, we determined that  $Tr_{min}$  for a slew rate of 10A/ $\mu\text{s}$  is at least 5.76  $\mu\text{s}$  so the actual transition time will be limited to no less than 5.76  $\mu\text{s}$ .

#### Maximum $Tr$

Use the following formula to calculate the maximum transition time for a given slew rate:

$$Tr_{max} = \frac{240}{\text{slew rate (A/us)}} * 0.8 \mu\text{s}$$

For a slew rate of 10A/ $\mu\text{s}$ , this results in:

$$Tr_{max} = \frac{240}{10} * 0.8 \mu\text{s} = 19.2 \mu\text{s}$$

#### Example 2:

Assume high current level C-high = 100A and low current level C-low = 0A. Assume 100A represents more than 30% of the current range for the DC load model used. If the slew rate is set to 10A/ $\mu\text{s}$ , the expected transition time would be:

$$Tr = \frac{0.8 * (100 - 0)}{10} \mu\text{s} = 8.0 \mu\text{s}$$

Since  $Tr_{max}$  for a slew rate of 10A/ $\mu\text{s}$  is 19.2  $\mu\text{s}$  so the actual transition time will be larger of these two values or 19.2  $\mu\text{s}$ .

### 3.4 Current Read-back

The load current levels and load status can be set from the front panel or over the remote control interface. During testing, load input voltage and load current can be read back but the current read back will typically display the average current level unless the dynamic current frequency setting is low enough. An analog current monitor output is provided to allow capturing of dynamic current on a digital storage scope or data recorder.

### 3.5 Analog Input Mode

An analog input is provided at the rear panel to allow analog programming of load current using a function or arbitrary waveform generator. This allows any current profile within the performance envelope of the DC load to be used for perform dynamic load testing beyond the built in dynamic CC mode.

**Note:** This mode is supported in Constant Current (CC) and Constant Power (CP) modes only.

### 3.6 Product Features

The following key characteristics apply to all 5P Series models.

- Fully programmable electronic DC load with flexible configuration and dual range capabilities.
- Fully remote control of all load settings and metering read back.
- Dual high accuracy and high-resolution 5 digit voltage and current meters.
- Built-in pulse generator includes wide Thigh/Tlow dynamic load range, independent Rise/Fall load current slew rate control, and High/Low load level.
- Controllable load current slew rate of load level change,
- Load ON/OFF switch change and power supply turn ON.
- Short circuit test with current measure capability.
- Dedicated over current and over power protection test functions
- Automatic voltage sensing and external sense.
- Full protection from over power, over temperature, over voltage, and reverse polarity.
- Analog programming input
- Current monitor output signal (non-isolated)
- Variable fan speed control for quieter operation
- Easy roll, lockable casters allow deployment of load cabinet in multiple locations

### 3.7 Accessories Included

The following accessories are included with each 5P Series DC Load. If one or more of these is missing upon incoming inspection of the product, please contact Adaptive Power Systems customer service.

Item	Quantity
Operation Manual in hardcopy or PDF Format	1
AC Line Cord	1
Analog Input BNC Cable (1 meter/39.4")	1
Voltage Sense alligator clip lead, Red (1 meter, 39.4")	1
Voltage Sense alligator clip lead, Black (1 meter, 39.4")	1
M6 Round Screw	2
Certificate of Conformance	1

Table 3-2: Included Accessories

### 3.8 Interface Options

Following options can be ordered at time of original purchase or may be added at a later time.

Option	Model No.
RS-232 Interface Option	Opt RS-232
GPIB Interface Option	Opt GPIB
USB Interface Option, Includes LAN/USB Driver CD ROM	Opt USB
LAN Interface Option, Includes LAN/USB Driver CD ROM	Opt LAN

Table 3-3: Available Remote Control Interface Options

### 3.9 Load Cable Options

The user may assembly his own DC load cable as desired. Alternatively, Adaptive Power Systems offers pre-assembled high current capable load cables in different lengths.

APS Model	Description	Min. Order Qty.
OPT-C1KA1	Load Cable, 1000A rated, 1 meter	2
OPT-C1KA2	Load Cable, 1000A rated, 2 meter	2
OPT-C1KA3	Load Cable, 1000A rated, 3 meter	2
OPT-C1KA4	Load Cable, 1000A rated, 4 meter	2
OPT-C1KA5	Load Cable, 1000A rated, 5 meter	2

Table 3-4: Available Load Cable Options

## 4 Technical Specifications

Technical specifications shown here apply at an ambient temperature of 25° C ± 5°. Refer to V-I curve and Very Low Voltage V-I Curve charts by models for operating envelope.

### 4.1 Operating Ranges

MODEL	5P024-24	5P024-48	5P036-24	5P036-48	5P036-72	5P054-36	5P054-72
<b>OPERATING RANGES</b>							
Power Ranges	0-240W/0-2400W	0-240W/0-2400W	0-360W/0-3600W	0-360W/0-3600W	0-360W/0-3600W	0-540W/0-5400W	0-540W/0-5400W
Current Ranges	0-24A/0-240A	0-48A/0-480A	0-24A/0-240A	0-48A/0-480A	0-72A/0-720A	0-36A/0-360A	0-72A/0-720A
Voltage Range	0 - 60 V	0 - 60 V	0 - 60 V	0 - 60 V	0 - 60 V	0 - 60 V	0 - 60 V
Minimum Voltage	0.6V @ 240 A	0.7 V @ 480 A	0.6V @ 240 A	0.7 V @ 480 A	0.7 V @ 720 A	0.6 V @ 360 A	0.7 V @ 720 A

MODEL	5P054-99	5P072-48	5P072-96	5P090-60	5P108-72	5P126-84	5P144-96
<b>OPERATING RANGES</b>							
Power Ranges	0-540W/0-5400W	0-720W/0-7200W	0-720W/0-7200W	0-900W/0-9000W	0-1080W/0-10800W	0-1260W/0-12600W	0-1440W/0-14400W
Current Ranges	0-100A/0-1000A	0-48 A /0-480 A	0-96 A /0-960 A	0-60 A /0-600 A	0-72 A /0-720 A	0-84 A /0-840 A	0-96 A /0-960 A
Voltage Range	0 - 60 V	0 - 60 V	0 - 60 V	0 - 60 V	0 - 60 V	0 - 60 V	0 - 60 V
Minimum Voltage	0.7 V @ 1000 A	0.6 V @ 480 A	0.6 V @ 960 A	0.6 V @ 600 A	0.6 V @ 720 A	0.6 V @ 840 A	0.6 V @ 960 A

## 4.2 Operating Modes

MODEL		5P024-24	5P024-48	5P036-24	5P036-48	5P036-72	5P054-36	5P054-72
<b>OPERATING MODES</b>								
CC Mode	Range	0 - 24 A / 240 A	0 - 48 A / 480 A	0 - 24 A / 240 A	0 - 48 A / 480 A	0 - 72 A / 720 A	0 - 36 A / 360 A	0 - 72 A / 720 A
	Resolution	0.4 mA / 4 mA	0.8 mA / 8 mA	0.4 mA / 4 mA	0.8 mA / 8 mA	1.2 mA / 12 mA	0.6 mA / 6 mA	1.2 mA / 12 mA
	Accuracy	± 0.1% OF (SETTING + RANGE)						
CR Mode	Range	0.0041 / 0.25 / 15kΩ	0.002 / 0.125 / 7.5kΩ	0.0041 / 0.25 / 15kΩ	0.002 / 0.125 / 7.5kΩ	0.00138 / 0.0833 / 5kΩ	0.0027 / 0.167 / 10kΩ	0.00138 / 0.0833 / 5kΩ
	Resolution	0.0041mΩ / 0.066mS	0.002mΩ / 0.1333mS	0.0041mΩ / 0.066mS	0.002mΩ / 0.133mS	0.00138mΩ / 0.2mS	0.0028mΩ / 0.1mS	0.0028mΩ / 0.1mS
	Accuracy	± 0.2% OF (SETTING + RANGE)						
CV Mode	Range	0-6.0 V/ 0-60V	0-6.0 V/ 0-60V	0-6.0 V/ 0-60V	0-6.0 V/ 0-60V	0-6.0 V/ 0-60V	0-6.0 V/ 0-60V	0-6.0 V/ 0-60V
	Resolution	0.1 mV / 1 mV	0.1 mV / 1 mV	0.1 mV / 1 mV	0.1 mV / 1 mV	0.1 mV / 1 mV	0.1 mV / 1 mV	0.1 mV / 1 mV
	Accuracy	± 0.05% OF (SETTING + RANGE)						
CP Mode	Range	0-240W/0-2400W	0-240W/0-2400W	0-360W/0-3600W	0-360W/0-3600W	0-360W/0-3600W	0-540W/0-5400W	0-540W/0-5400W
	Resolution	3 mW / 30 mW	4 mW / 40 mW	6 mW / 60 mW	6 mW / 60 mW	6 mW / 60 mW	9 mW / 90 mW	9 mW / 90 mW
	Accuracy	± 0.5% OF (SETTING + RANGE)						

MODEL		5P054-99	5P072-48	5P072-96	5P090-60	5P108-72	5P126-84	5P144-96
<b>OPERATING MODES</b>								
CC Mode	Range	0-100A/0-1000A	0-48A/0-480A	0-96A/0-960A	0-60A/0-600A	0-72A/0-720A	0-84A/0-840A	0-96A/0-960A
	Resolution	1.6 mA / 16 mA	0.8 mA / 8 mA	1.6 mA / 16 mA	1m A / 10 mA	1.2 mA / 12 mA	1.4 mA / 14 mA	1.6 mA / 16 mA
	Accuracy	± 0.1% OF (SETTING + RANGE)						
CR Mode	Range	0.001 / 0.06 / 3.6kΩ	0.002 / 0.125 / 7.5kΩ	0.001 / 0.0625 / 3750Ω	0.0017 / 0.1 / 6kΩ	0.00138 / 0.083 / 5kΩ	0.0012 / 0.0714 / 4284Ω	0.001 / 0.0625 / 3750Ω
	Resolution	0.001mΩ / 0.277mS	0.002mΩ / 0.13mS	0.001mΩ / 0.267mS	0.0016mΩ / 0.016mS	0.0014mΩ / 0.2mS	0.0003mΩ / 0.23mS	0.001mΩ / 0.267mS
	Accuracy	± 0.2% OF (SETTING + RANGE)						
CV Mode	Range	0-6.0 V/ 0-60V	0-6.0 V/ 0-60V	0-6.0 V/ 0-60V	0-6.0 V/ 0-60V	0-6.0 V/ 0-60V	0-6.0 V/ 0-60V	0-6.0 V/ 0-60V
	Resolution	0.1 mV / 1 mV	0.1 mV / 1 mV	0.1 mV / 1 mV	0.1 mV / 1 mV	0.1 mV / 1 mV	0.1 mV / 1 mV	0.1 mV / 1 mV
	Accuracy	± 0.05% OF (SETTING + RANGE)						
CP Mode	Range	0-540W/0-5400W	0-720W/0-7200W	0-720W/0-7200W	0-900W/0-9000W	0-1080W/0-10800W	0-1260W/0-12600W	0-1440W/0-14400W
	Resolution	9 mW / 90 mW	12mW/120mW	12mW/120mW	15mW/150mW	18mW/180 mW	21mW/210mW	24mW/240mW
	Accuracy	± 0.5% OF (SETTING + RANGE)						

### 4.3 Protection Modes

MODEL	5P024-24	5P024-48	5P036-24	5P036-48	5P036-72	5P054-36	5P054-72
<b>PROTECTION</b>							
Over Power (OP)	2520 W	2520 W	3780 W	3780 W	3780 W	5670 W	5670 W
Over Current (OC)	252.0 A	504.0 A	252.0 A	504.0 A	756.0 A	378.0 A	756.0 W
Over Voltage (OV)	63.0 V	63.0 V	63.0 V	63.0 V	63.0 V	63.0 V	63.0 V
Over Temperature (OT)	+85° C / +185° F						

MODEL	5P054-99	5P072-48	5P072-96	5P090-60	5P108-72	5P126-84	5P144-96
<b>PROTECTION</b>							
Over Power (OP)	5670 W	7560 W	7560 W	9450 W	11340 W	13320 w	15120 W
Over Current (OC)	1050 A	504.0 A	1008 A	630.0 A	756.0 A	882.0 A	1008 A
Over Voltage (OV)	63.0 V	63.0 V	63.0 V	63.0 V	63.0 V	63.0 V	63.0 V
Over Temperature (OT)	+85° C / +185° F						

### 4.4 Dynamic Operation Mode

MODEL	5P024-24	5P024-48	5P036-24	5P036-48	5P036-72	5P054-36	5P054-72
<b>DYNAMIC OPERATION</b>							
T high & T low	0.050 - 9.999 / 99.99 / 999.9 / 9999ms (20 kHz)						
Resolution	0.001 / 0.01 / 0.1 / 1ms						
Accuracy	1µs / 10µs / 100µs / 1ms + 50ppm						
Slew Rate	0.016A-1A/µs	0.032A-2A/µs	0.016A-1A/µs	0.016A-1A/µs	0.048A-3A/µs	0.024A-1.5A/µs	0.048A-3A/µs
	0.16A-10A/µs	0.32A-20A/µs	0.16A-10A/µs	0.16A-10A/µs	0.48A-30A/µs	0.24A-15A/µs	0.48A-30A/µs
Accuracy	± 5% OF SETTING ± 10 µs						
Min. Rise Time	24µs Typical						

MODEL	5P054-99	5P072-48	5P072-96	5P090-60	5P108-72	5P126-84	5P144-96
<b>DYNAMIC OPERATION</b>							
T high & T low	0.050 - 9.999 / 99.99 / 999.9 / 9999ms (20 kHz)						
Resolution	0.001 / 0.01 / 0.1 / 1ms						
Accuracy	1µs / 10µs / 100µs / 1ms + 50ppm						
Slew Rate	0.0664A-4.15A/µs	0.032A-2A/µs	0.064A-4A/µs	0.04A-2.5A/µs	0.048A-3A/µs	0.056A-3.5A/µs	0.064A-4A/µs
	0.644A-41.5A/µs	0.32A-20A/µs	0.64A-40A/µs	0.4A-25A/µs	0.48A-30A/µs	0.56A-35A/µs	0.64A-40A/µs
Accuracy	± 5% OF SETTING ± 10 µs						
Min. Rise Time	24µs Typical						

## 4.5 Metering

MODEL		5P024-24	5P024-48	5P036-24	5P036-48	5P036-72	5P054-36	5P054-72
<b>METERING</b>								
Voltage	Range	0 - 60.0 V / 60.0 V						
	Resolution	0.1 mV / 1 mV						
	Accuracy	± 0.025% OF (READING + RANGE)						
Current	Range	0 - 24 A / 240 A	0 - 48 A / 480 A	0 - 24 A / 240 A	0 - 48 A / 480 A	0 - 72 A / 720 A	0 - 36 A / 360 A	0 - 72 A / 720 A
	Resolution	0.4 mA / 4 mA	0.8 mA / 8 mA	0.4 mA / 4 mA	0.8 mA / 8 mA	1.2 mA / 12 mA	0.6 mA / 6 mA	1.2 mA / 12 mA
	Accuracy	± 0.1% OF (READING + RANGE)						
Power	Range	0 - 2400.0 W	0 - 2400.0 W	0 - 2400.0 W	0 - 3600.0 W	0 - 3600.0 W	0 - 5400.0 W	0 - 5400.0 W
	Resolution	0.1 W						
	Accuracy	± 0.125% OF (READING + RANGE)						
Analog Input (CC mode)		0 - 10V in for F.S. current @ 10V						

MODEL		5P054-99	5P072-48	5P072-96	5P090-60	5P108-72	5P126-84	5P144-96
<b>METERING</b>								
Voltage	Range	0 - 60.0 V / 60.0 V						
	Resolution	0.1 mV / 1 mV						
	Accuracy	± 0.025% OF (READING + RANGE)						
Current	Range	0-100A/0-1000A	0-48A/0-480A	0-96A/0-960A	0-60A/0-600A	0-72A/0-720A	0-84A/0-840A	0-96A/0-960A
	Resolution	1.6 mA / 16 mA	0.8 mA / 8 mA	1.6 mA / 16 mA	1m A / 10 mA	1.2 mA / 12 mA	1.4 mA / 14 mA	1.6 mA / 16 mA
	Accuracy	± 0.1% OF (READING + RANGE)						
Power	Range	0 - 5400.0 W	0 - 7200.0 W	0 - 7200.0 W	0 - 9000.0 W	0 - 10800.0 W	0 - 12600.0 W	0 - 14400.0 W
	Resolution	0.1 W						
	Accuracy	± 0.125% OF (READING + RANGE)						
Analog Input (CC mode)		0 - 10V in for F.S. current @ 10V						



#### 4.6 Miscellaneous

MODEL	5P024-24	5P024-48	5P036-24	5P036-48	5P036-72	5P054-36	5P054-72
<b>SHORT CIRCUIT</b>							
Max. Short Current	240 A	480 A	240 A	480 A	720 A	360 A	720 A
<b>ANALOG I/O</b>							
Analog Monitor Out	0 - 10 V out F.S. / 1K $\Omega$ Zout, Non-isolated						
Analog Input (CC mode)	0 - 10V in for F.S. current @ 10V						

MODEL	5P054-99	5P072-48	5P072-96	5P090-60	5P108-72	5P126-84	5P144-96
<b>SHORT CIRCUIT</b>							
Max. Short Current	1000 A	480 A	960 A	600 A	720 A	840 A	960 A
<b>ANALOG I/O</b>							
Analog Monitor Out	0 - 10 V out F.S. / 1K $\Omega$ Zout, Non-isolated						
Analog Input (CC mode)	0 - 10V in for F.S. current @ 10V						

#### 4.7 AC Input & Cooling

MODEL	ALL MODELS
<b>AC INPUT AND COOLING SPECIFICATIONS</b>	
AC Power	115/230Vac $\pm$ 10%, 50/60 Hz
Cooling	Variable Speed Fan Cooled

#### 4.8 Dimensions & Weight

MODEL	5P024-24	5P024-48	5P036-24	5P036-48	5P036-72	5P054-36	5P054-72
<b>DIMENSIONS AND WEIGHT</b>							
Dimensions (H x W x D)	889 x 596 x 600 mm / 35.0" x 23.5" x 23.6"						
Post June 2016 Dims	839 x 600 x 600 mm / 33.0" x 23.6" x 23.6"						
Weight (Net)	81.2kg/179.0 lb	81.2kg/179.0 lbs	81.2kg/179.0 lbs	81.2kg/179.0 lbs	81.2kg/179.0 lbs	104.8kg/231 lbs	104.8kg/231 lbs

MODEL	5P054-99	5P072-48	5P072-96	5P090-60	5P108-72	5P126-84	5P144-96
<b>DIMENSIONS AND WEIGHT</b>							
Dimensions (H x W x D)	889x596x600mm 35.0"x23.5" x 23.6"		1556 x 596 x 600 mm 61.3" x 23.5" x 23.6"			1778x596x600mm 70.0"x23.5"x23.6"	
Post June 2016 Dims	839x600x600mm 33.0"x23.6" x 23.6"		1061x600x600 mm 41.8x23.6"x23.6"	1283 x 600 x 600 mm 50.5" x 23.6" x 23.6"	1506x600x600 mm 59.3x23.6"x23.6"	1728x600x600mm 68.0"x23.6"x23.6"	
Weight (Net)	104.8kg/231lbs	161.4kg/356lbs	161.4kg/356lbs	185.0kg/408lbs	208.6kg/460lbs	232.2kg/512lbs	268.8kg / 593lbs

The 5P Series comes in varies cabinet heights to accommodate one or more slave DC loads connected to the master unit. The illustrations below are for a 5P024-24 model cabinet with one master and one slave unit but the interconnects between multiple units are the same.

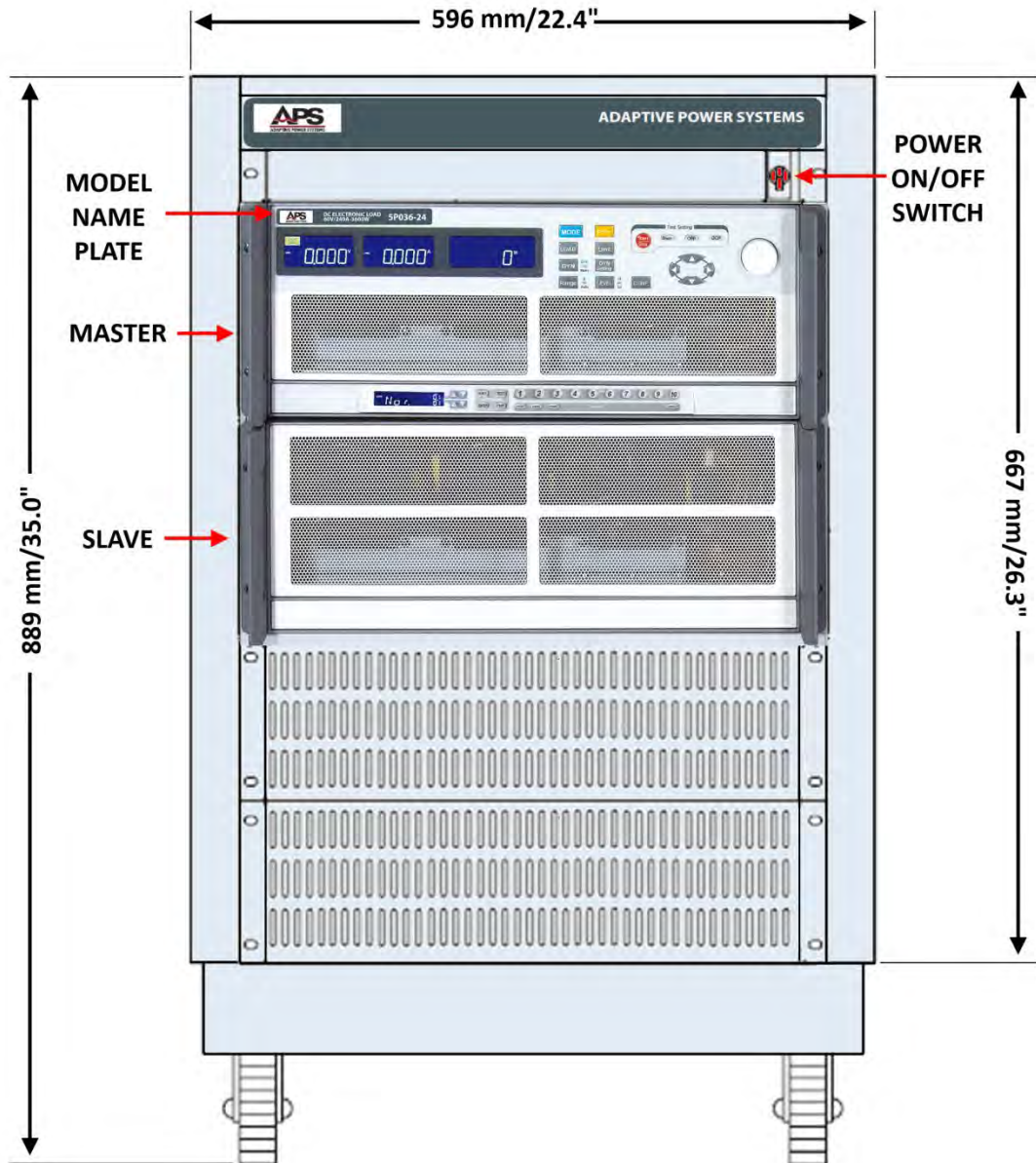

Figure 4-1: 5P Series Cabinet Layout – Front View (original dimensions)

Dimensions for systems shipped after June 2016.

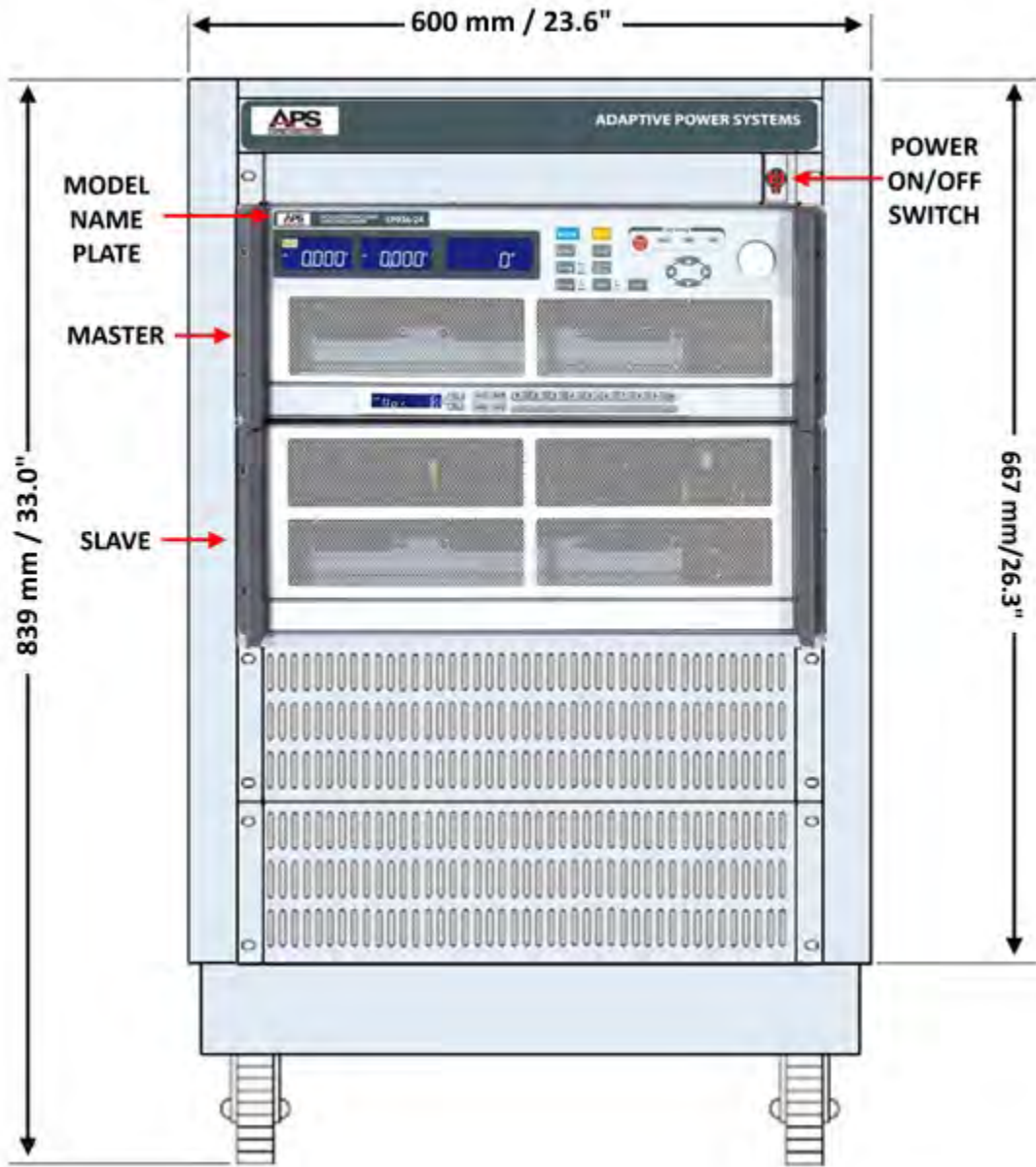
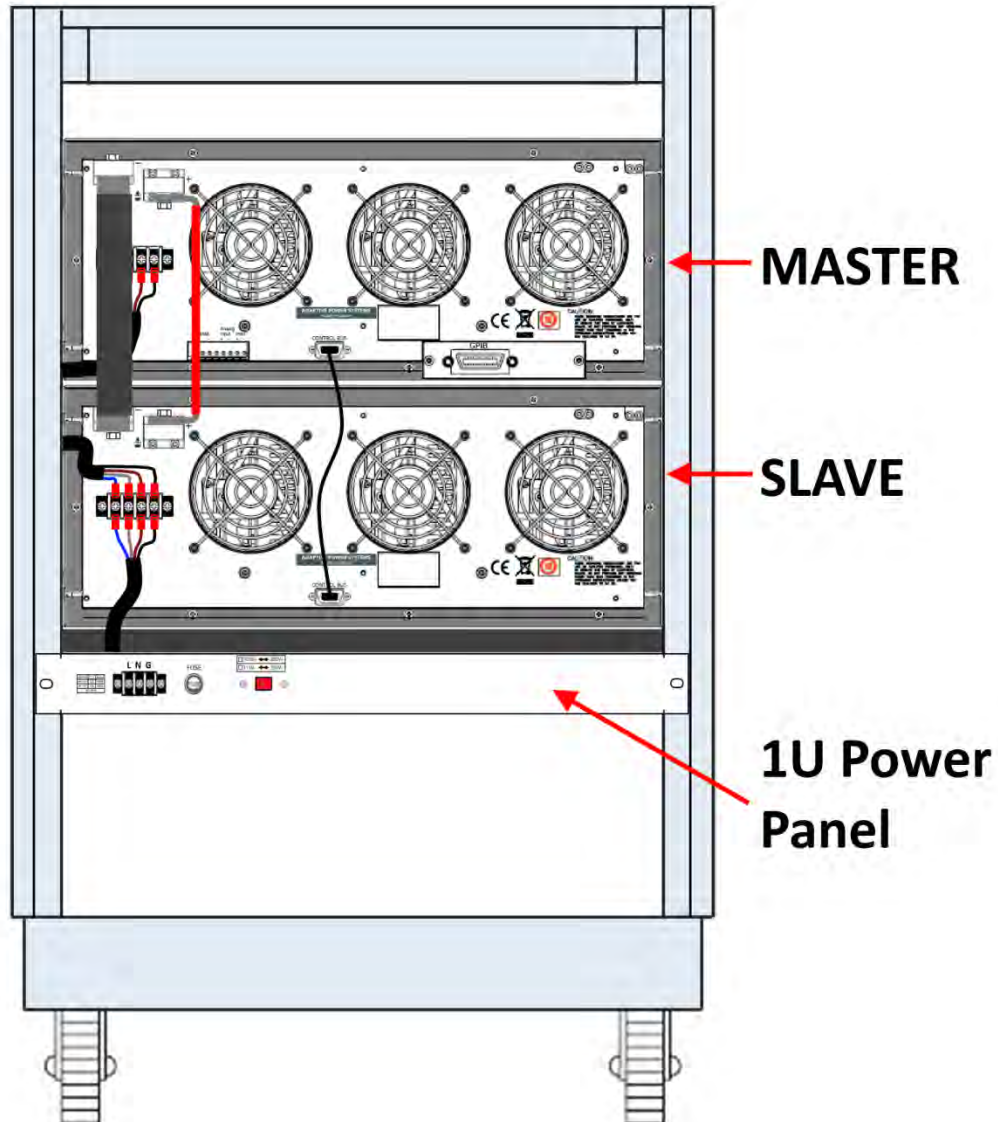

Figure 4-2: 5P Series Cabinet Layout – Front View

The rear of the cabinet has the power supply wiring harness from the master power supply of the cabinet to the various load chassis. A control busy daisy chain connection cable is installed to allow the master unit to control and synchronize all slave units.



*Figure 4-3: 5P Series Cabinet Layout - Rear View*

## 4.9 Environmental

MODEL	ALL MODELS
<b>ENVIRONMENTAL</b>	
Operating Temperature	0 - 40° C / 32 - 104° F
Relative Humidity	80% max. non-condensing
Environmental	Indoor Use Only, Pollution Degree 2
Altitude	2000 meter / 6500 feet max. Operating
EMC & Safety	CE Mark

#### 4.10 Voltage versus Current Operating Envelope Charts

Following charts show constant power operating envelopes for each mode. For operation at voltages below 1.0 Vdc, refer to the Low Voltage Operating charts. Operation below the red line shown in these charts is not specified.

Charts are shown by model on following pages.

4.10.1 Model 5P024-24 V-I Curves

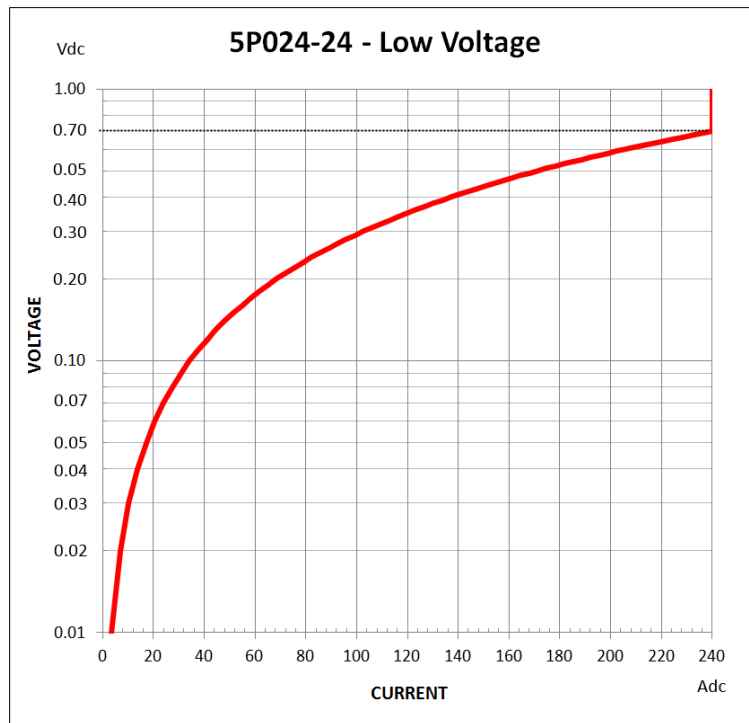
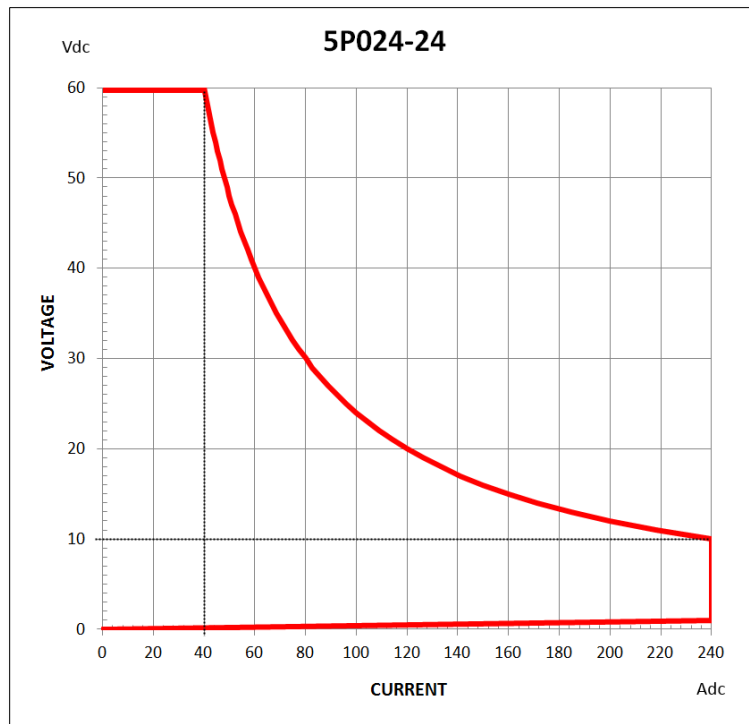



4.10.2 Model 5P024-48 V-I Curves

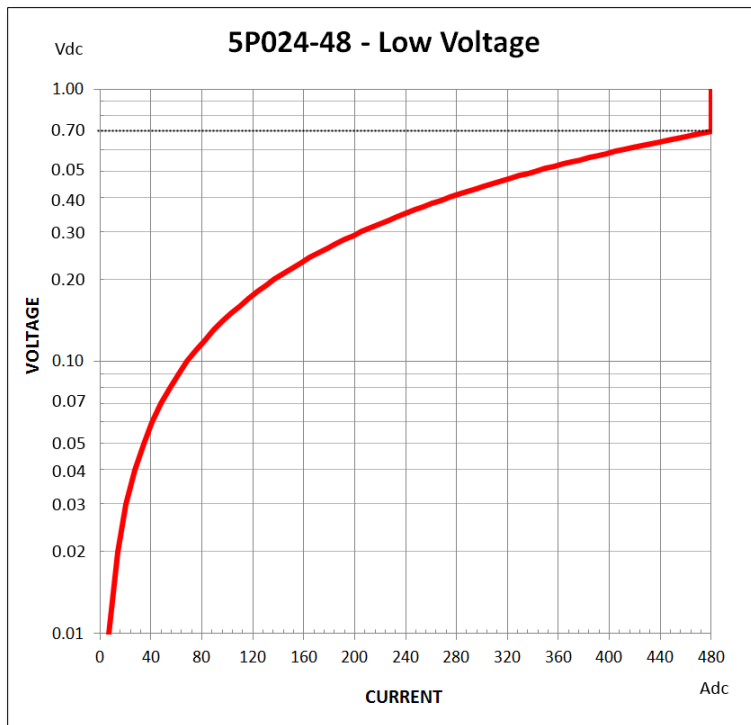
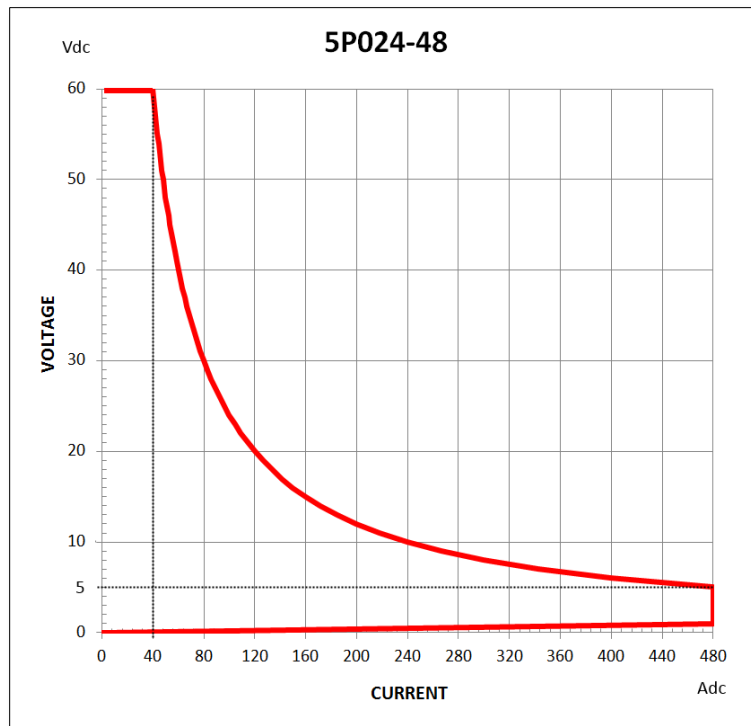

4.10.3 Model 5P036-24 V-I Curves

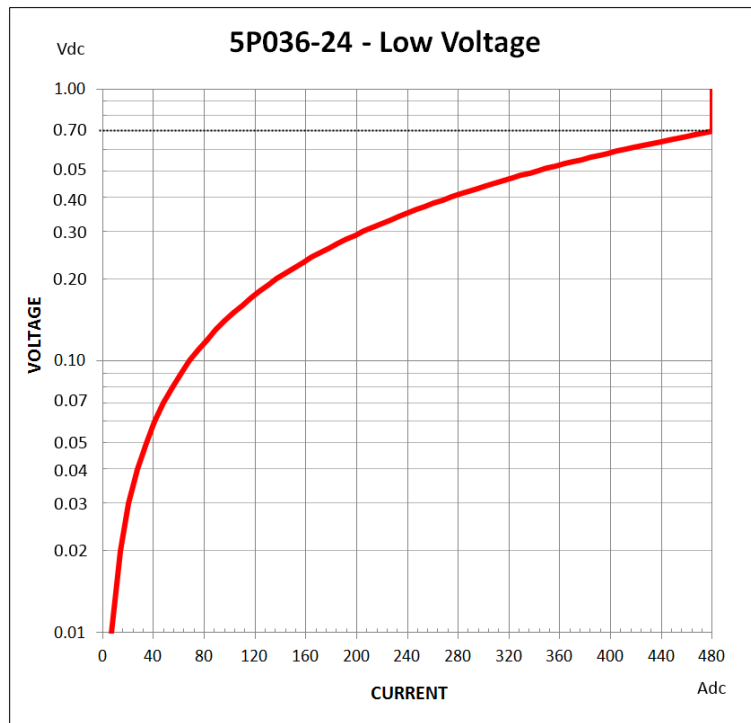
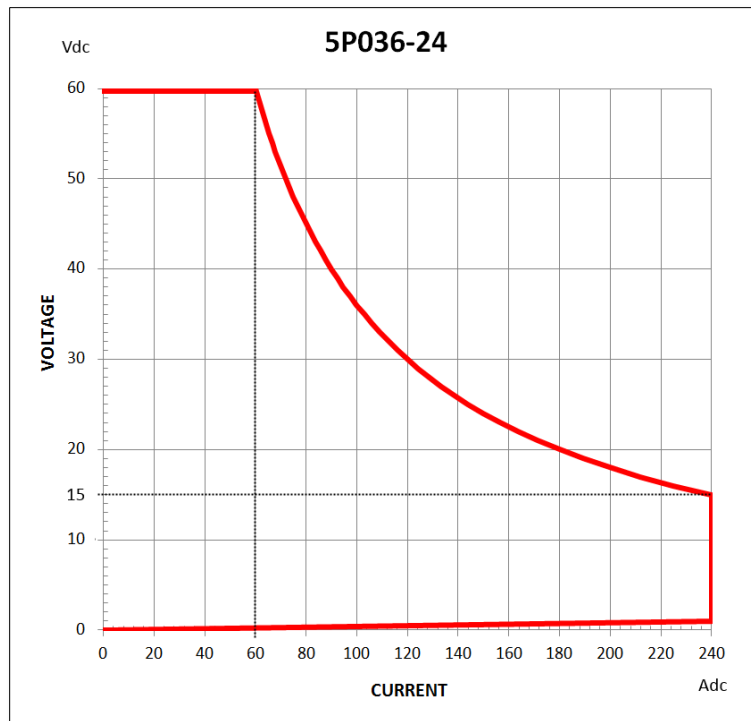

4.10.4 Model 5P036-48 V-I Curves

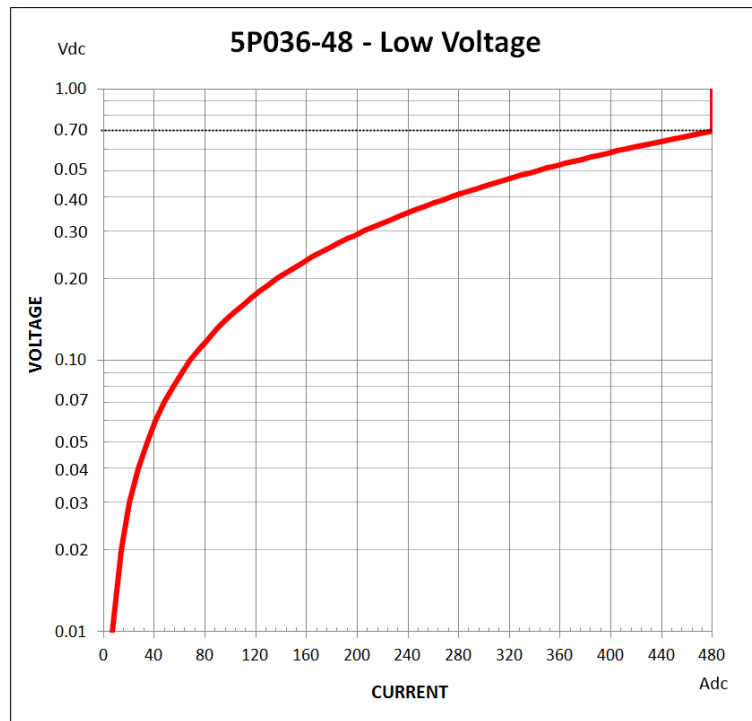
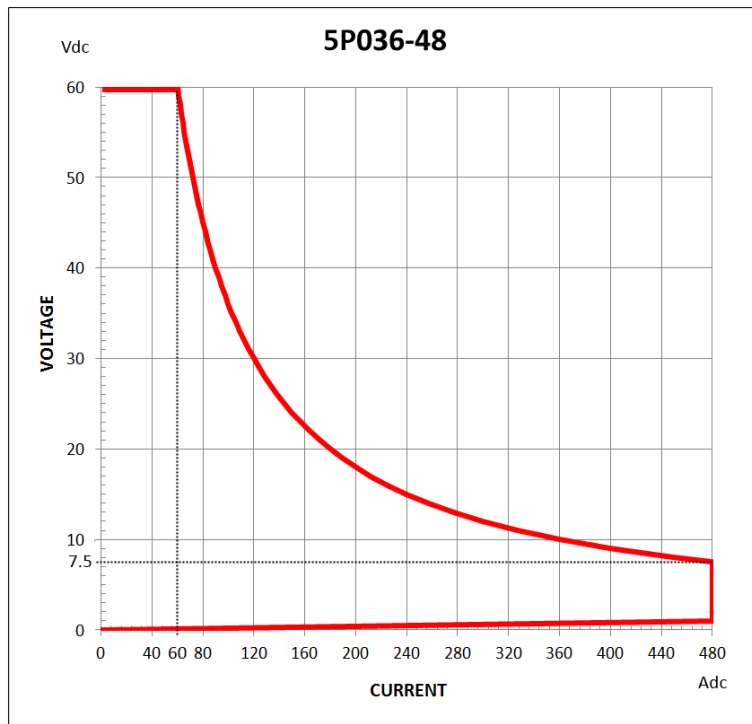

4.10.5 Model 5P036-72 V-I Curves

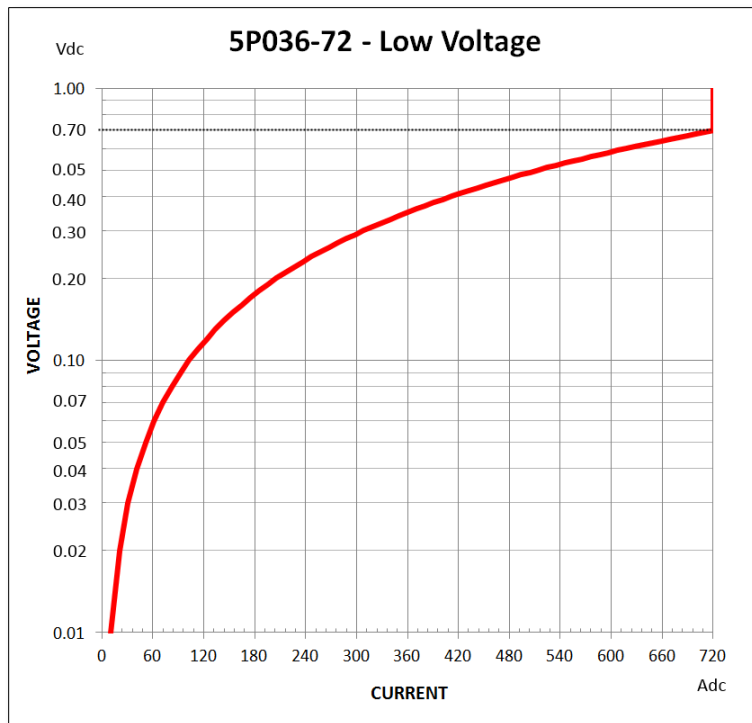
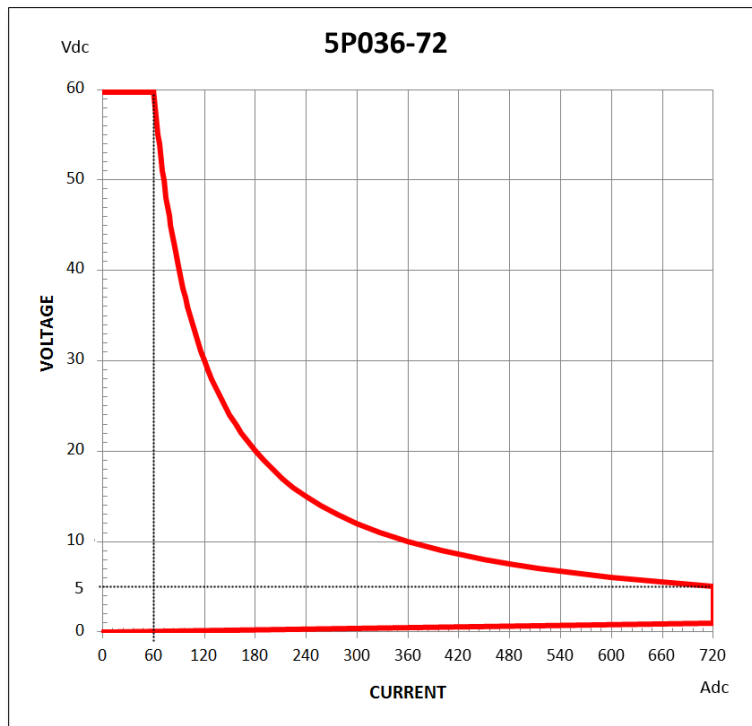

4.10.6 Model 5P054-36 V-I Curves

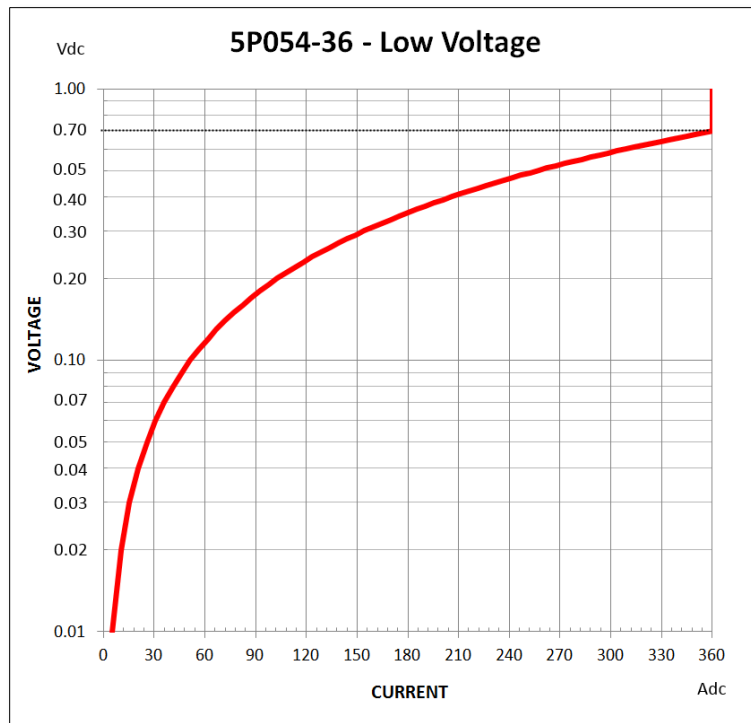
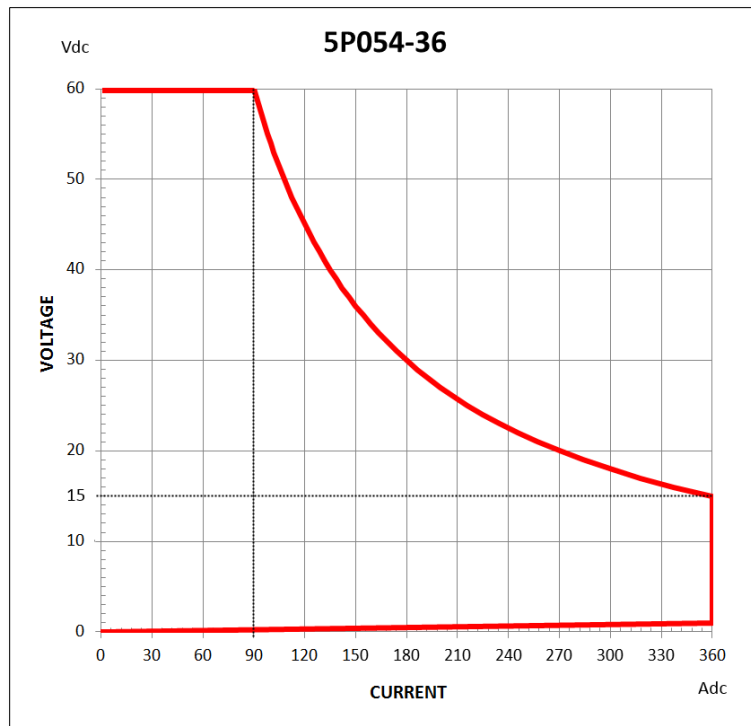

4.10.7 Model 5P054-72 V-I Curves

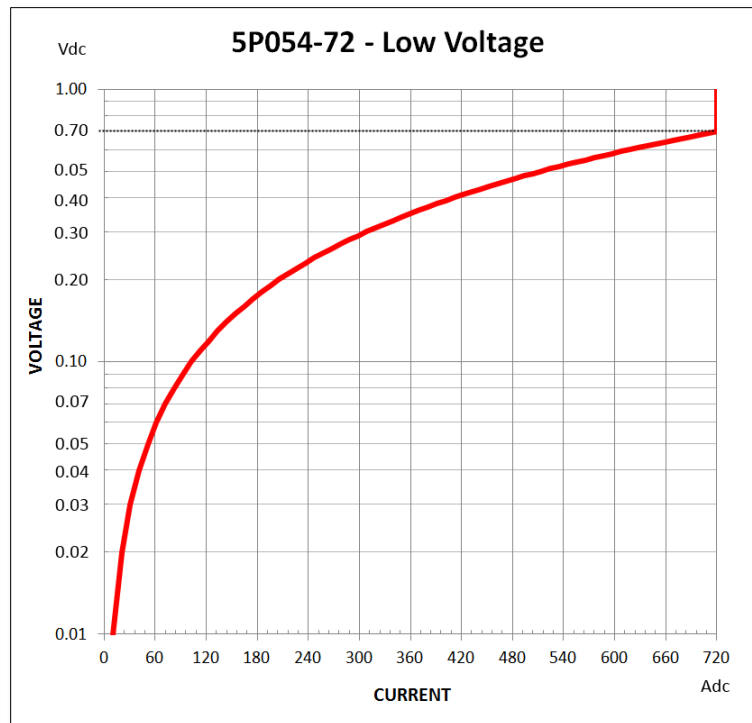
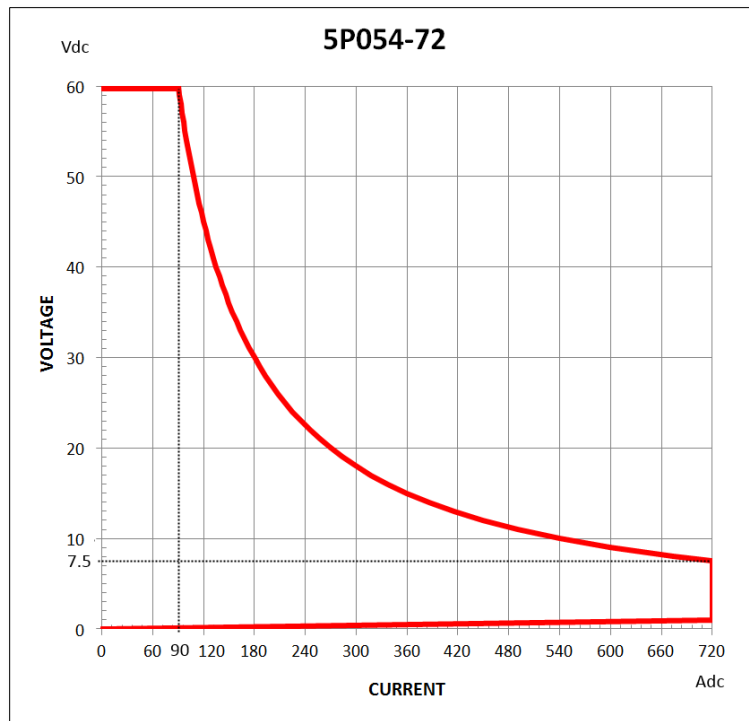

4.10.8 Model 5P054-99 V-I Curves

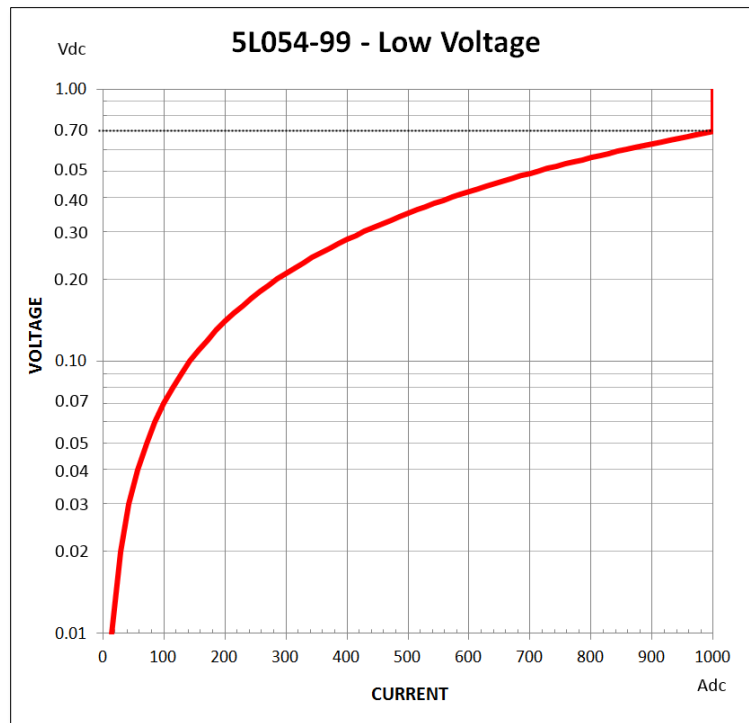
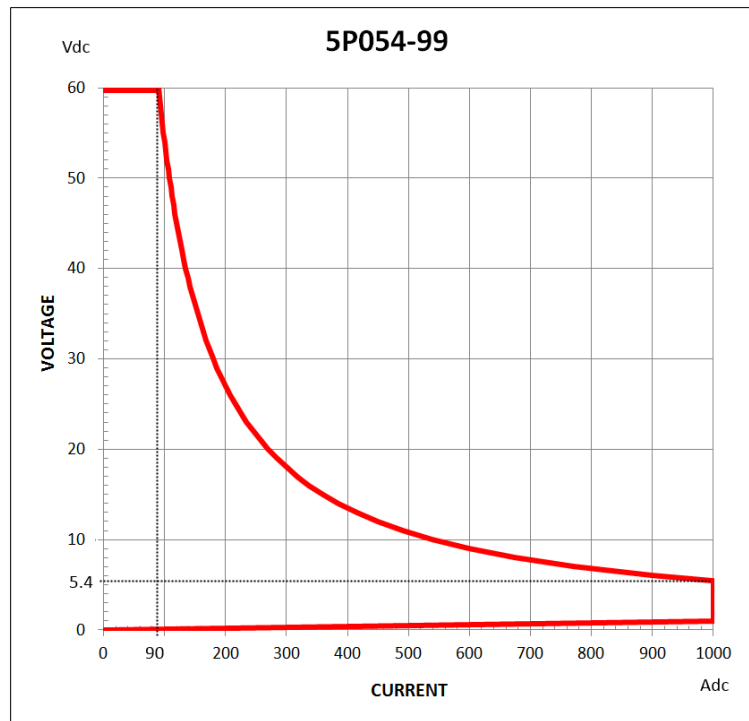

4.10.9 Model 5P072-48 V-I Curves

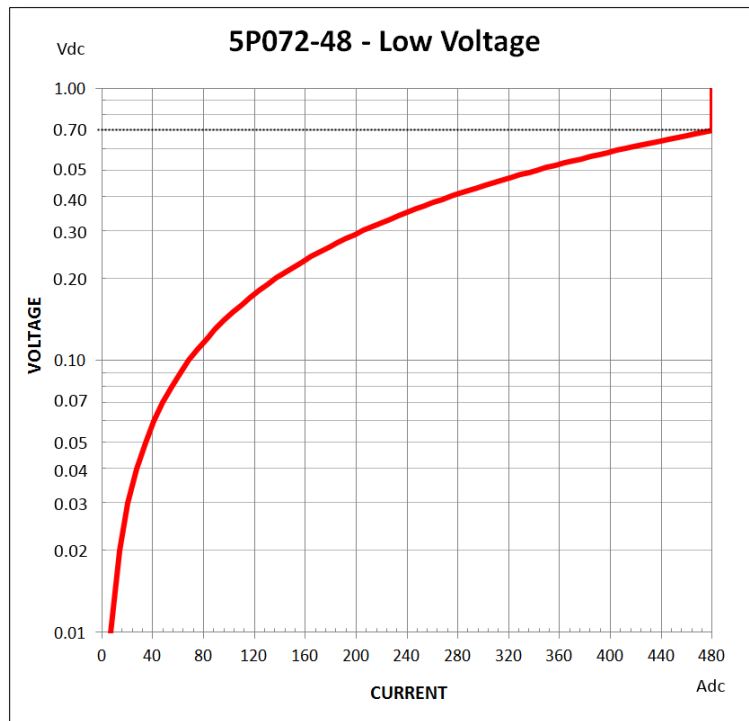



4.10.10 Model 5P072-96 V-I Curves

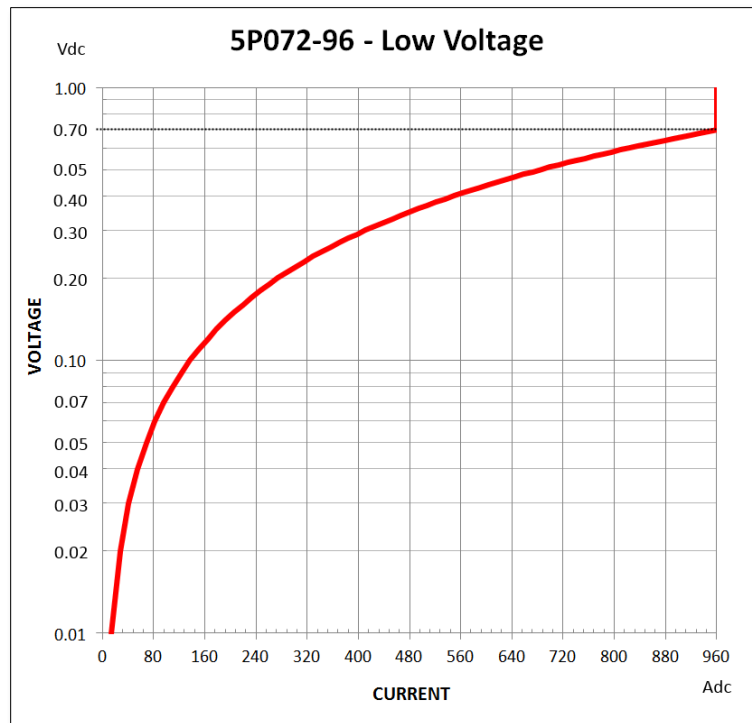
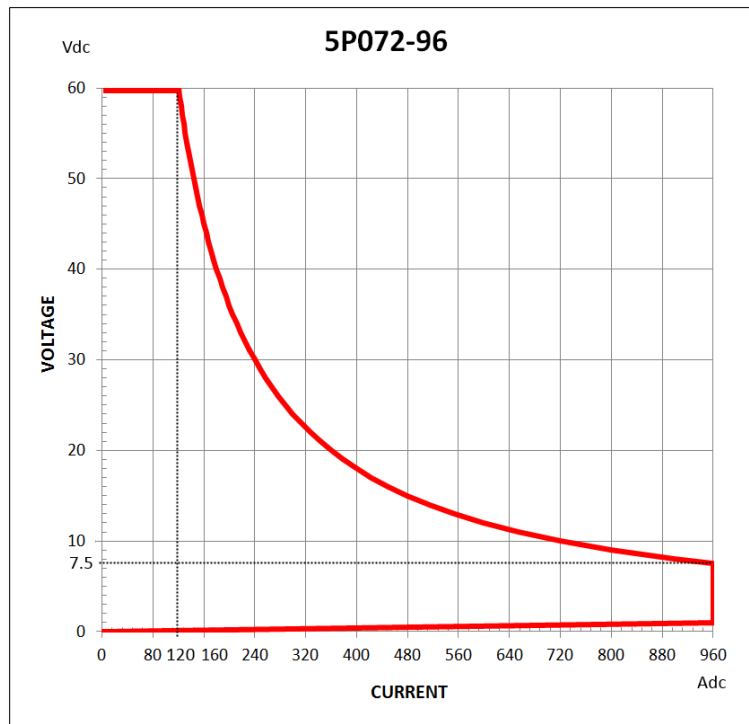

4.10.11 Model 5P090-60 V-I Curves

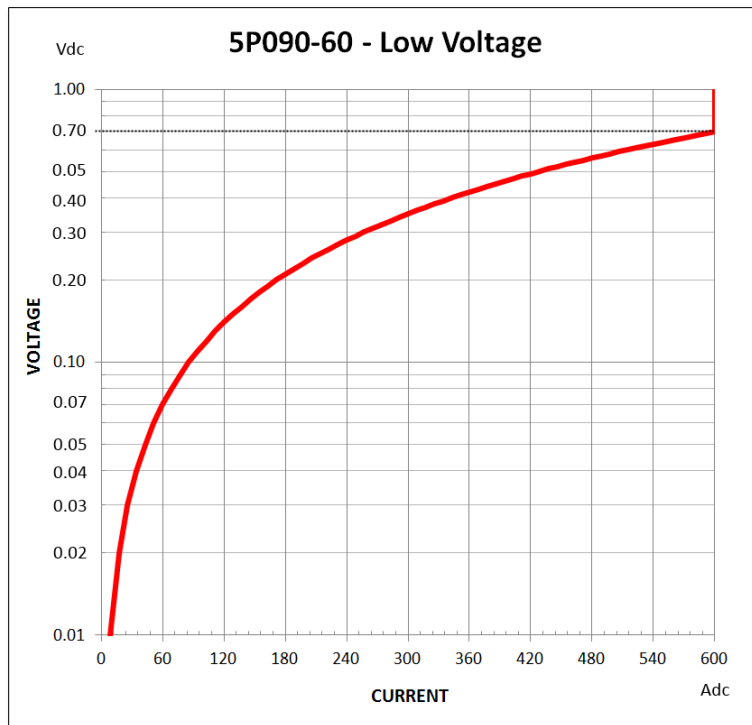
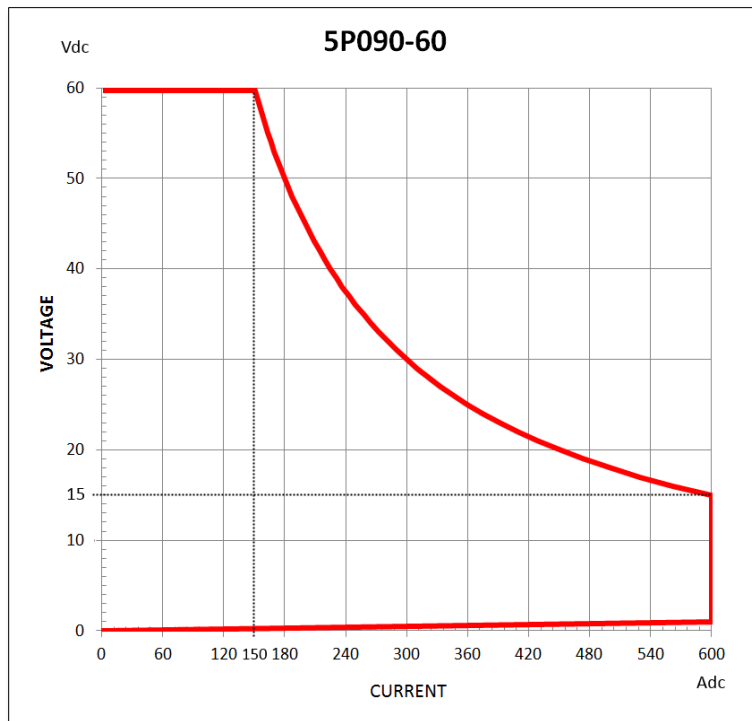

4.10.12 Model 5P0108-72 V-I Curves

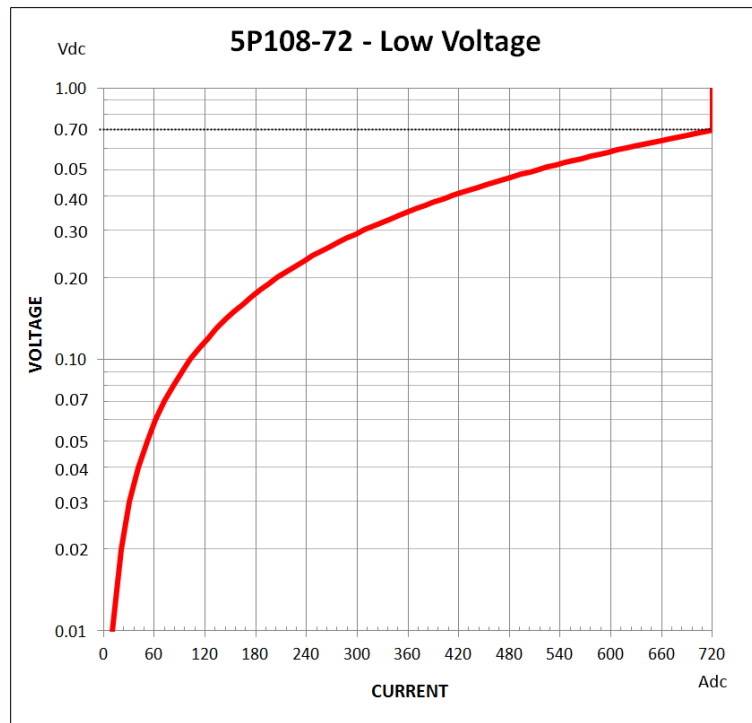
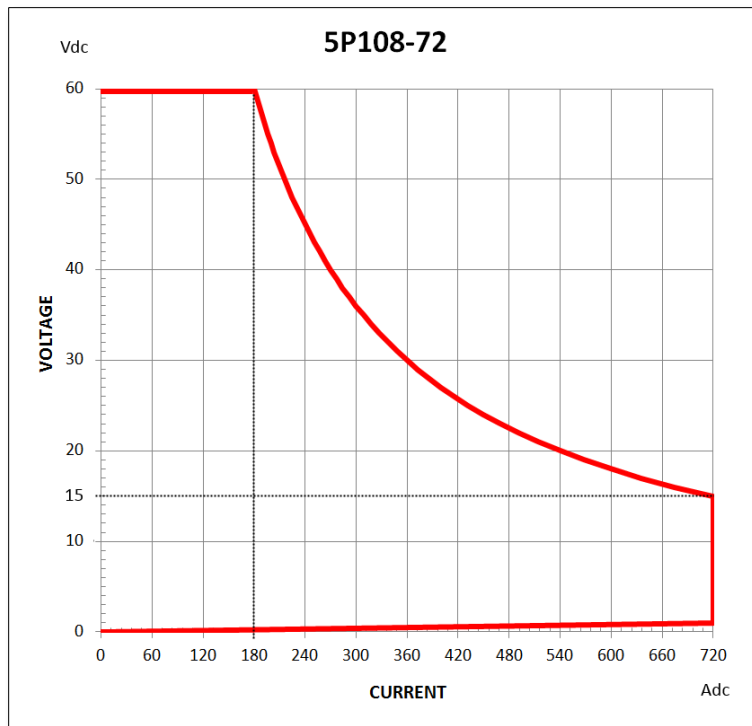

4.10.13 Model 5P126-84 V-I Curves

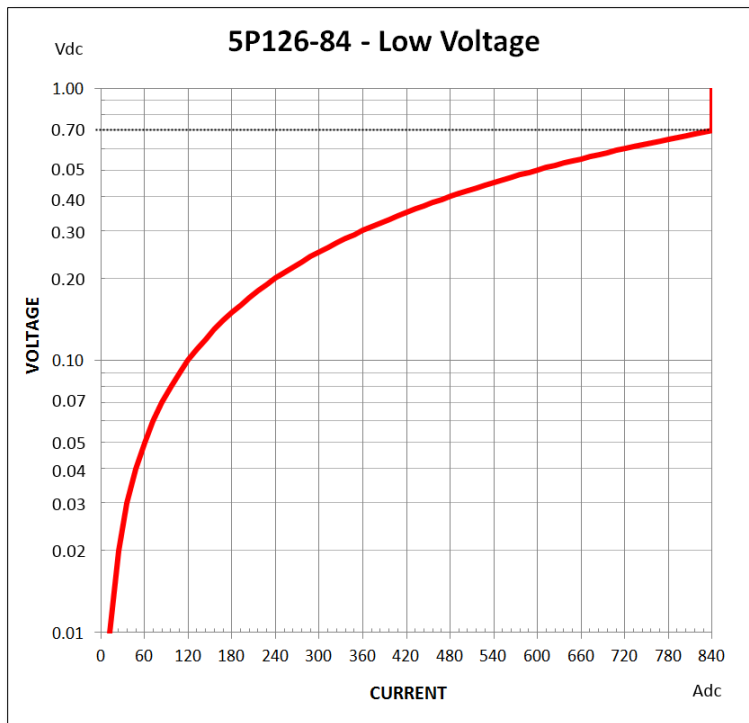
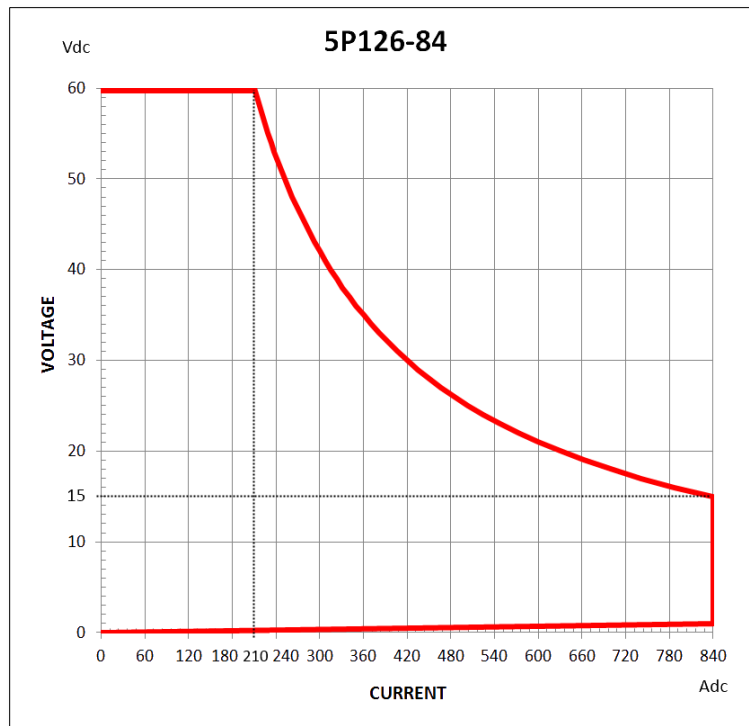

4.10.14 Model 5P144-96 V-I Curves

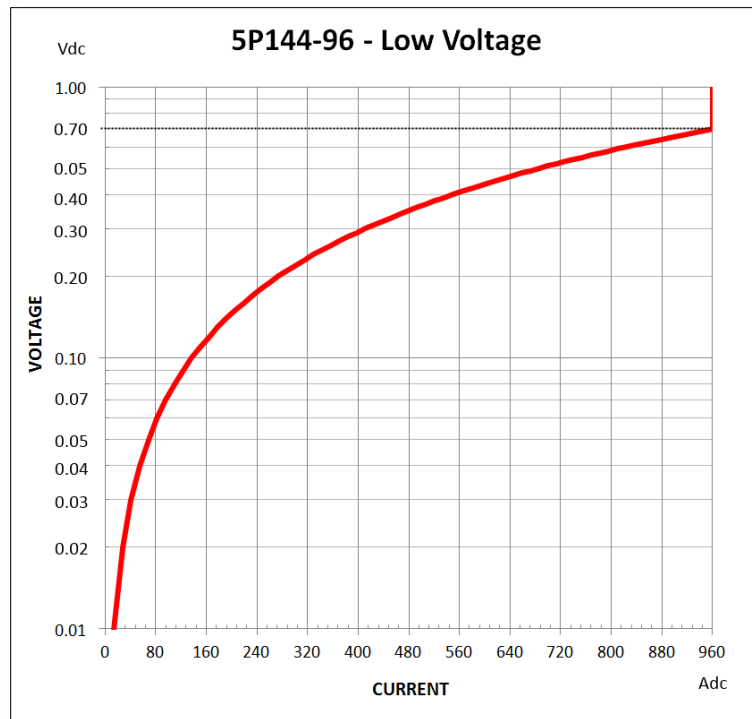
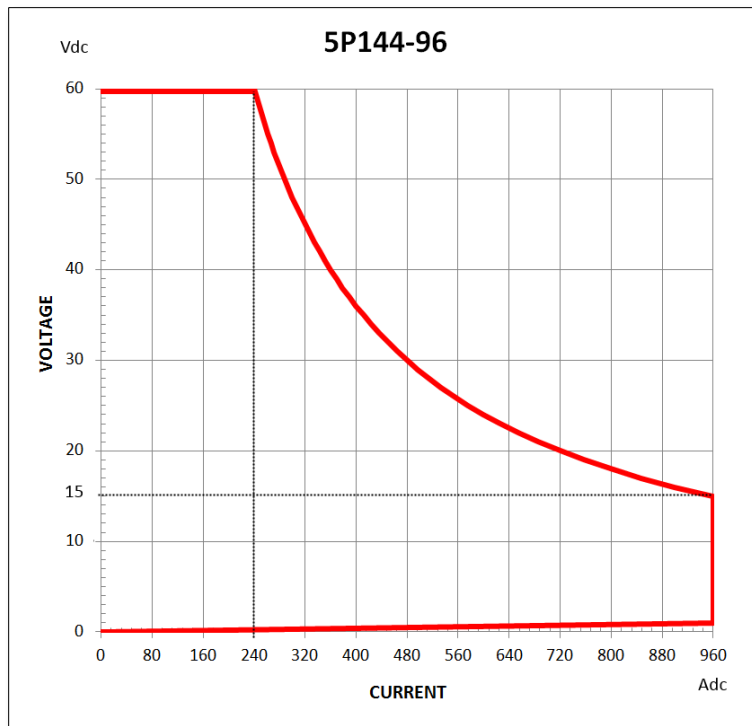

## 5 Unpacking and Installation

### 5.1 Inspection

The 5P Series DC loads are carefully inspected before shipment. If instrument damage has occurred during transport, please inform Adaptive Power Systems' nearest sales and service office or representative.

Your DC load was shipped with a power cord for the type of outlet used at your location. If the appropriated cord was not included, please contact your nearest sales office to obtain the correct cord. Refer to "check line voltage" to check the line voltage selection and fuse type.

### 5.2 Check Line Voltage

The 5P Series load can be operated with a 115Vac or 230Vac input as indicated on the label on the rear panel. Make sure that the factory check mark corresponds to your nominal line voltage. Skip this procedure if the label is correctly marked.

1. With the 5P Series load powered OFF, disconnect the AC power cord.
2. Refer the drawing on the rear panel of 5P Series load in Figure 5-2, set the switches to the proper voltage as indicated below.

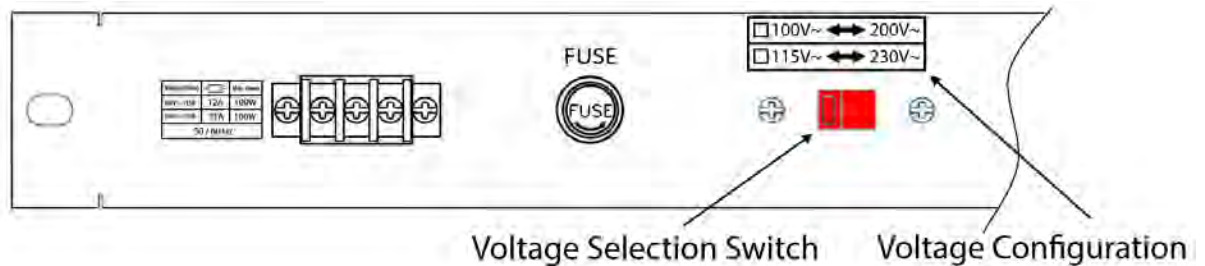



Figure 5-2: AC Input Voltage Selection

### 5.3 Input Fuse

This product is fitted with a mains input fuse. If it needs to be replaced, please adhere to the following procedure.

CAUTION

**BEFORE** replacing the fuse you must switch off the unit and mains power outlet and disconnect the plug of the AC Power cable from the input socket of the load chassis.

WARNING

If prior to exchanging the fuse, there is any abnormal noise or odor, do not use the unit. Please inform your local sales office to organize repair of the chassis.

To avoid the risk of fire or electronic shock the fuse must only be replaced with same type and rating as the original. Any replacement fuse used should meet local national safety standards. Any use of an improper fuse or shorting the Fuse holder is extremely dangerous and is strictly prohibited.

### 5.3.1 Fuse Replacement Procedure

To replace the AC line input fuse, proceed as follows:

1. Check the rating of the mains input fuse. Replace only with the correct type and rating. Note that the fuse ratings depends on the number of loads that are installed in the cabinet. Refer to the table below for the relevant fuse rating.

Rating	1 Master + 1 Slave	1 Master + 2 Slaves	1 Master + 3 Slaves	1 Master + 4 Slaves	1 Master + 5 Slaves	1 Master + 6 Slaves	1 Master + 7 Slaves
AC 110V / AC 115V	T4A/250V (5*20mm)	T4A/250V (5*20mm)	T6A/250V (5*20mm)	T6A/250V (5*20mm)	T8A/250V (5*20mm)	T8A/250V (5*20mm)	T10A/250V (5*20mm)
AC 200V / AC 230V	T2A/250V (5*20mm)	T2A/250V (5*20mm)	T4A/250V (5*20mm)	T4A/250V (5*20mm)	T4A/250V (5*20mm)	T4A/250V (5*20mm)	T6A/250V (5*20mm)

2. The AC line fuse is located below the AC line socket (see Fig 2-2). Use a small screwdriver to remove the fuse holder. Replace the failed fuse with the appropriate type and rating according to your mains voltage. (See Table 1-2)
3. Refit the fuse holder and connect the power cord.

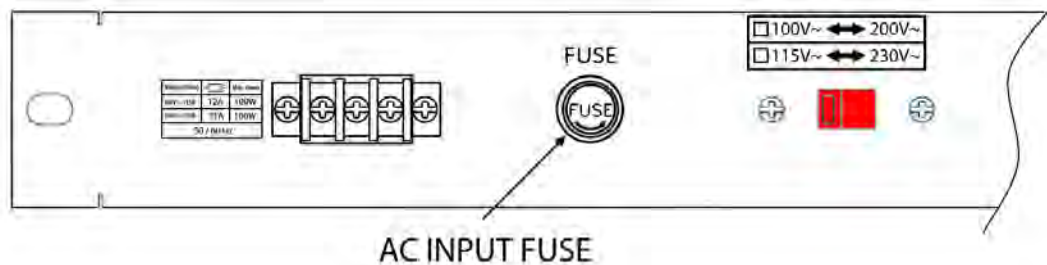

Figure 5-3: Fuse Holder Location

### 5.4 Grounding Requirements





The unit is grounded via the AC Input. A line cord with proper Earth Ground pin must be used at all times. Correct grounding of your electrical system infrastructure according to applicable national standards must also be observed.

### 5.5 Chassis Position

The 5P Series load chassis is equipped with surface protection feet and tilt stands installed and is ready for used as a bench instrument. The feet provide a good viewing angle for bench-top use.

### 5.6 Rack Mounting

The 5P Series chassis is designed to be rack mounted in a standard 19 inch rack for system applications. If needed, the feet and tilt-stands may be removed to accommodate zero stacking with other test equipment.

### 5.7 Cleaning

To clean this product uses a soft or slightly damp cloth.

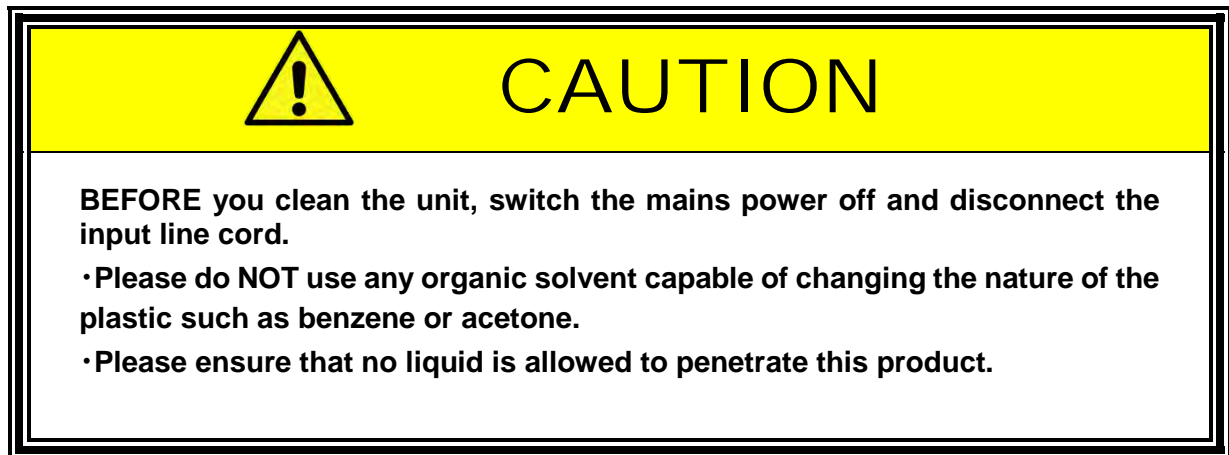

### 5.8 Powering Up

The following procedure should be followed before applying mains power:

1. Check that the POWER switch – located at the upper right front of the cabinet is in the OFF (O) position.
2. Verify that the rear panel voltage selector of the chassis is correctly set.
3. Check that nothing is connected to any of the DC INPUT (load input terminals) on the front and/or rear panels.
4. Connect the correct AC mains line cord to the 5P Series load AC input terminal.
5. Plug the line cord plug into a suitable AC outlet socket.

6. Turn on (I) the POWER switch.
7. If the instrument does not turn on for some reason, turn OFF the POWER switch and verify the presence of the correct AC line input voltage using appropriate safety measures.

## 5.9 In Case of Malfunction

In the unlikely event of an instrument malfunction or if the instrument does not turn on despite the presence of the correct AC line voltage, please attach a warning tag to the instrument to identify the owner and indicate that service or repair is required. Contact Adaptive Power Systems or its authorized representative to arrange for service.

## 5.10 Load Connection

 **WARNING**

### DO NOT EXCEED LOAD INPUT VOLTAGE RATING

This instrument does NOT have a means to disconnect its Load input from a connected power supply. If the voltage applied to the Load input exceeds its maximum rating – even if the load is turned completely off – damage to the load WILL occur. Damage caused by exceeded maximum load input voltage under any circumstance is NOT covered by the manufacturer’s product warranty. Remove any load input connections when the load is not in use, even when it is turned off.

When setting up for a new test and connecting any equipment to the DC load, proceed as follows:

1. Always make sure the DC load is turned OFF at the POWER switch when making any wire connections.
2. Check that the output of the equipment under test is **OFF**.  
**Note:** Some power equipment’s output may still be energized even if the equipment has been turned off or its output is turned off. This is especially true for DC power supplies.  
  
**Note:** When working with batteries, it is recommended to provide a suitable disconnect relay or switch so the load connection can be disconnected from the battery for handling purposes.
3. Connect one end of the load wires to the load input terminals on the rear panel.

4. Check the polarity of the connections and connect the other end of the load wires to the output terminal of the equipment under test.
5. When connecting multiple loads to the same EUT, makes sure the load wire lengths to each load are the same.

## 5.11 Interface Options

The 5P Series supports one of four different remote control interface options. The interface specified at the time of order is installed at the factory prior to shipment. It is possible to retrofit interface options in the field. Contact Adaptive Power Systems Customer Service for instructions.

### 5.11.1 RS232 Serial Interface

Figure 5-4 shows the RS232 connector (Female) on the rear panel. This connects the load unit to an RS232 port of a computer. The RS232 BAUD-RATE can be set on the front panel of the load. Press the “SYSTEM” button twice to enter the desired BAUD RATE adjustment.



Figure 5-4: RS232 Connection

### 5.11.2 GPIB Interface

The GPIB connector is located on the rear panel. This socket allows the load to be connected to the controller and other GPIB devices. A GPIB system can be connected in any configuration (star, linear, or both) as long as the following conditions are met:

- The maximum number of devices including the controller is equal or less than 15.
- The maximum length of the GPIB cable is no more than 2 meters.
- The total lead length of all devices connected together totals less than 20 meters.
- Please make sure the lock screws are firmly hand-tightened, use a screwdriver only for the removal of screws. Figure 5-5 shows the rear panel of load. The GPIB address of the load is set on the front panel.

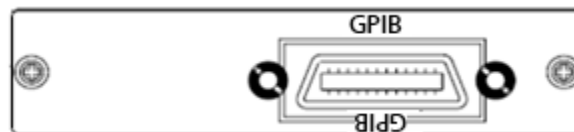

Figure 5-5: GPIB Connection

### 5.11.3 USB Interface

The 5P Series load is a USB Device and uses a USB Type B connector on the rear panel when equipped with the USB interface option. Figure 5-6 shows the USB connector in the rear panel of the load. Please refer Appendix B for information on USB communications.



Figure 5-6: USB Connection

### 5.11.4 LAN Interface

The LAN option uses a 100BaseT Ethernet interface. Figure 5-7 shows the LAN connector on the rear panel of the load. Please refer Appendix C for information on LAN communications.



Figure 5-7 LAN Connection

### 5.11.5 GPIB & RS232 Combination Interface

Figure 5-8 shows the combination GPIB & RS232 connectors (Female) on the rear panel. Note that only one interface can be used at a time. When changing between interface types, the 5P Load must be re-booted (power cycled). In all aspects, these interfaces are identical to the ones covered in sections 5.11.1 and 5.11.2.

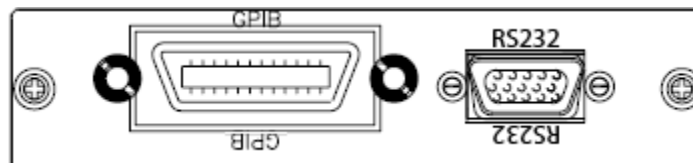

Figure 5-8: RS232 Connection

## 5.12 Analog Programming Input

The 5P Series has an analog programming input located on the rear panel. This feature allows an external waveform to be tracked as long as it is within the load's dynamic capabilities. The analog programming input is available through a compression terminal block on the rear panel of the 5P Series load. These inputs will accept a 0-10V signal. This signal is proportional to the load's maximum current range.

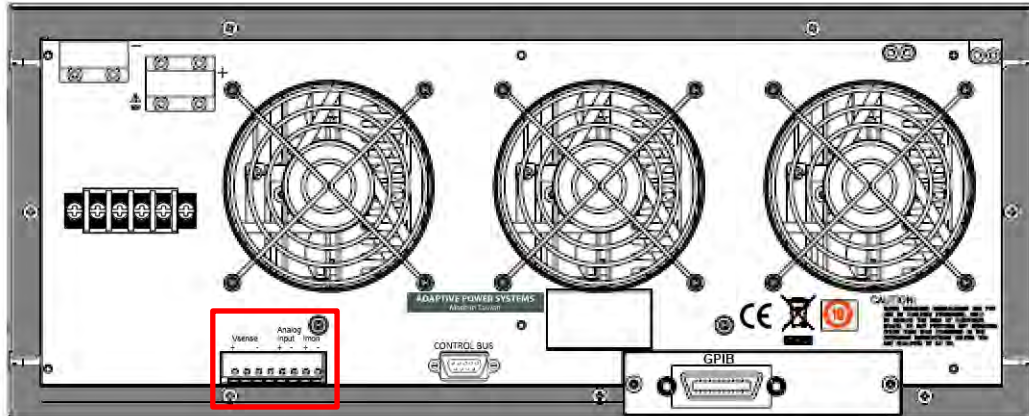

Figure 5-9: Location and Pin-out of Analog Programming Input Connector on 5P Master Unit

The analog programming input operates in CC or CP modes only. The load module will attempt to load proportionally according to the signal and the load module's maximum current or power range.

For example: 5P024-24:  $I_{max} = 240A$  and  $P_{max} = 2400W$

- In CC mode, if the analog programming input is 4V, the load current will be  $0.4 \times 240 = 96A$ .
- In CP mode, if the analog programming input is 1V, the load power setting will be  $0.1 \times 2400 = 240W$ .

The analog programming signal can act alone or it can be summed with the programmed value set via the front panel or the optional computer interface (GPIB, RS232, USB, or LAN) or the front panel.

Figure 5-10 shows the result of an analog programming signal at 4Vac, 500Hz when it is summed with a 24A programmed setting in CC mode of DC load.

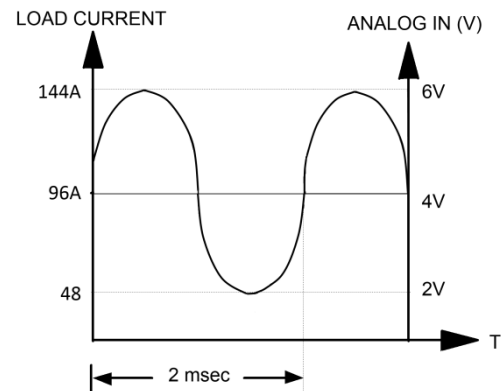

Figure 5-10: Analog Programming Example

### 5.13 Load Current Slew Rate

The programmable current slew rate of the DC load allows control over the rate of change in current any time a change in current occurs. This controls the load current slew rate during load current level changes, power supply turn ON/OFF events or when turning the LOAD ON, and OFF. The 5P Series Electronic loads provide controlled current slewing under all of these conditions. The rise and fall current slew rate can each be set independently.

For example, on Models 5P024-24 and 5P036-24, the rise and fall slew rates can be independently programmed from 0.16A/ $\mu$ s to 10AA/ $\mu$ s in the 240A current range and from 0.016A/ $\mu$ s to 1A/ $\mu$ s in the 24A current range. This allows an independent controlled transition from Low load current level to High load current level ( Rise current slew rate ) or from High load current level to Low load current level( Fall current slew rate ) to minimize induced voltage drops on the wiring inductance, or to control induced voltage transients on the device under test (power supply transient response testing).

See under “DYNAMIC OPERATION, Slew Rate” in the specification section on page 21 for slew rate programming range for other models.

This controllable load current slew rate feature also can eliminate the overload current phenomenon and emulate the actual load current slew rate at turn ON of the power supply under test. Figure 5-11 shows the load current slew rate is according to the power supply's output voltage, load level setting and Load ON/OFF switch.

The ability to apply all these dynamic current characteristics at the same time using the Constant Current mode of the 5P Series load greatly speeds up power supply testing tasks. This can significantly improve the test quality, thoroughness and efficiency.

There are two load current ranges in 5P Series Load, Range I and Range II, the rise and fall slews rate range for both current ranges is specified in Section 4.1, “Technical Specifications” on page 21.

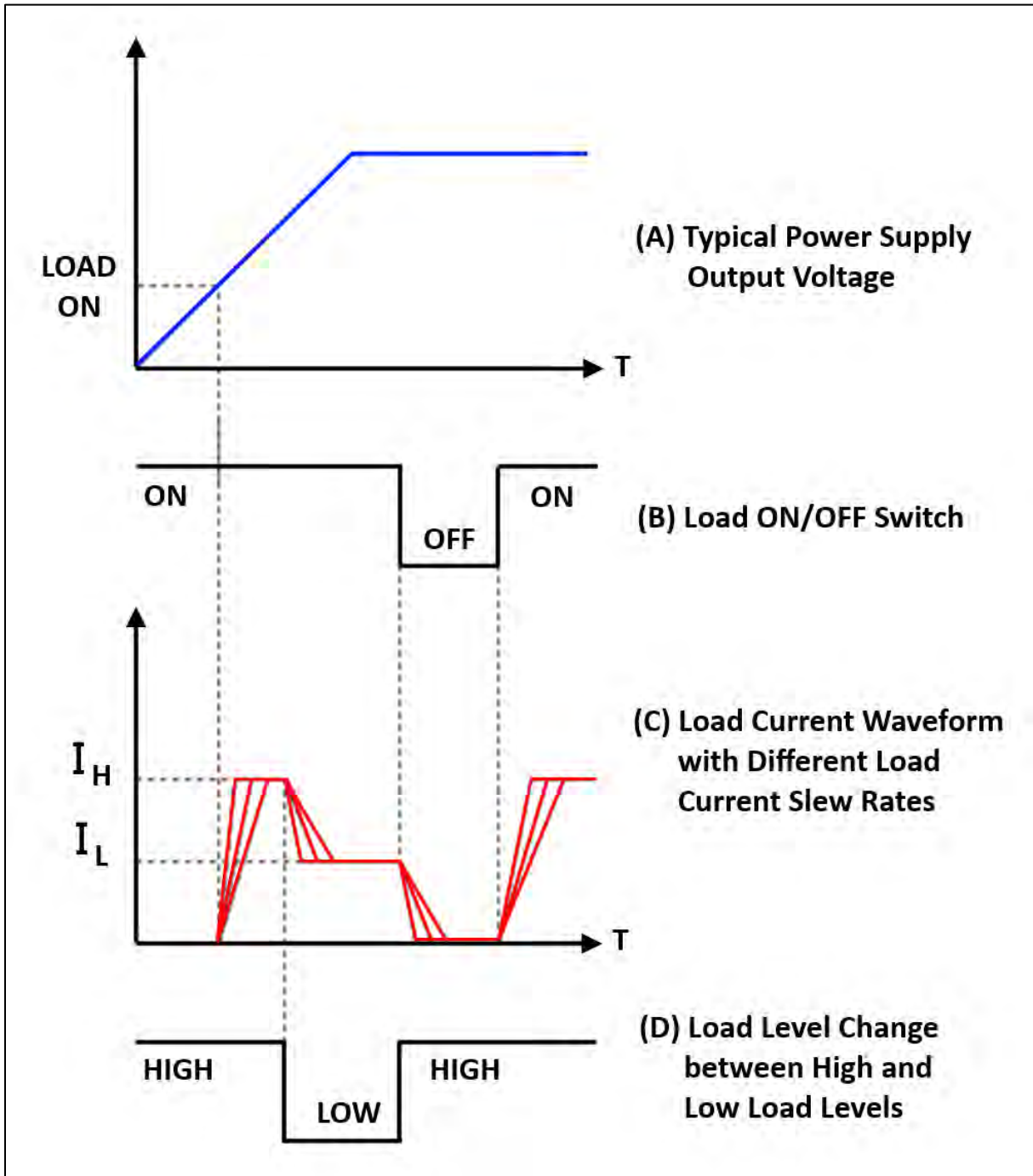

Figure 5-11: Effect of Current Slew Rate Settings on Power Supply Testing



## 6 Front Panel Operation

This Chapter provides an overview of front panel operation for the 5P Series DC Loads. For remote control operation, refer to Section 8 “Remote Control Programming” of this manual for an overview of available programming commands.

### 6.1 Front Panel Layout

The front panel layout of the 5P Series master unit is shown in Figure 6-1 below. The master unit is typically located near the top of the cabinet with the slave units placed underneath. This makes the front panel of the master easily accessible and readable.



Figure 6-1: 5P Series DC Load Front Panel View

Large LCD readouts are located along the top left edge. User controls are located to the right of these displays. Along the bottom edge, memory bank controls are positioned next to a separate memory bank and system setting display. The power ON/OFF switch is found in the lower left corner.

The center section of the front panel is left clear to allow ambient air to enter for cooling purposes. Air is exhausted at the rear of unit aided by a series of variable speed fans.

**Note:** For optimal cooling, the air intake section on the front panel should not be blocked in any way. Also, some clearance of at least 6 inches / 15 cm should be allowed at the back of the unit from any wall or other obstruction so air can move freely through the load.

## 6.2 User Controls and Readouts

The following user controls, indicator and displays are common to all 5P Series load models. The purpose and function of each control and indicator is explained in the table below. Refer to figure for the location of each control and indicator. Note that for purposes of this documentation, the keys are shown below the LCD displays whereas on the actual unit, the keys are to the right of the LCD displays.

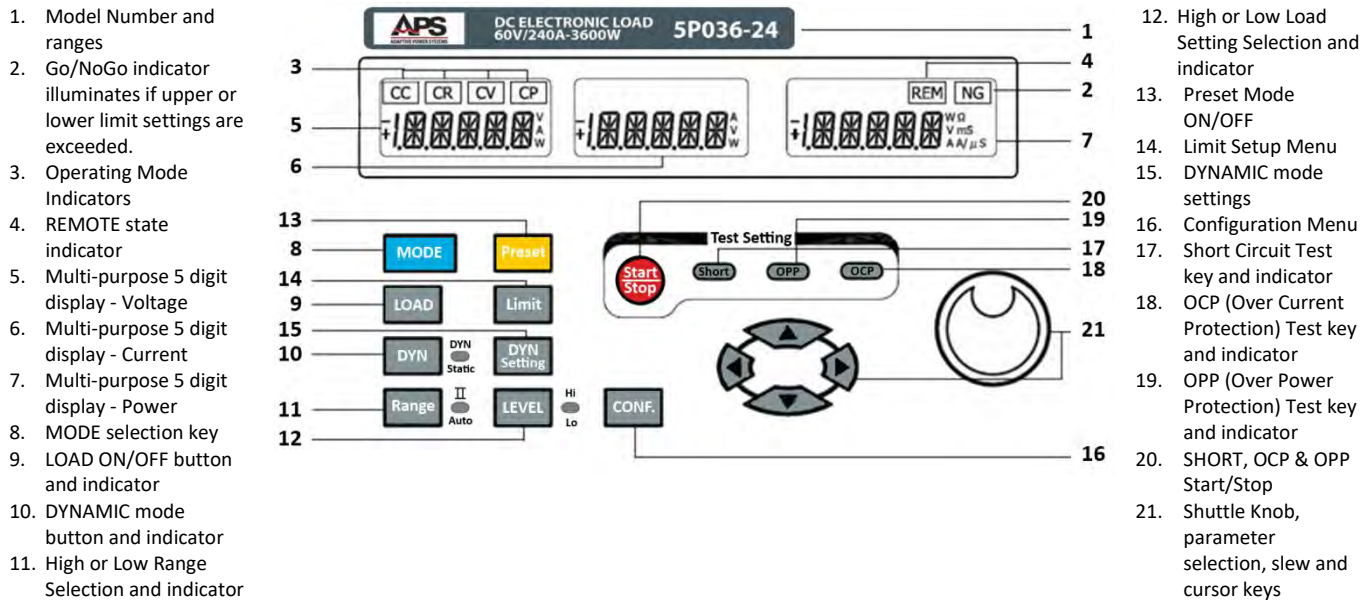

Figure 6-2: Front Panel User Controls and Indicators

The various controls and indicators are explained in more detail in the table below. The Item numbers correspond to the indices in Figure above.

Key #	Description
1	Indicates the <b>model number</b> and key performance specifications of the load.
2	<b>Go/NoGo</b> indicator illuminates if upper or lower limit settings are exceeded.
3	There are four operating modes can be selected by pressing the "MODE" key on the electronic load The sequence is Constant Current ( CC ), Constant Resistance ( CR ), Constant Voltage ( CV ), Constant Power ( CP ) and then repeats. When pressing the "MODE" key, the CC, CR, CV, CP mode indicator will be lit respectively when the appropriate operating mode is selected. The operating theorem of CC, CR, CV and CP mode is described in Section 3.2, "Operating Modes". There are two programming ranges in CC, CR, CV and CP mode respectively; the 5P Series load can adjust to the optimal range automatically according to the programmed load level. The range selection criteria are described below for each operating mode.

Key #	Description
	<p><b>CC Mode</b></p> <p>Range I indicates low load current operating range, Range II indicates high load current operating range. The specification of load current ranges is listed in section 4.1, "Operating Ranges". The current range is changed automatically in accordance to the programmed load current.</p> <p>Range I is selected automatically if the programmed load current is less than the maximum current of Range I, and will be set to Range II automatically when the programmed current is higher than the maximum current of Range I.</p>
	<p><b>CR Mode</b></p> <p>Range I indicates low load resistance operating range, Range II indicates high load resistance operating range. The specification of the resistance ranges is shown in section 4.1, "Operating Ranges". The resistance range is changed automatically in accordance to the programmed load resistance.</p> <p>The electronic load will switch to Range I automatically if the programmed load resistance is higher than the minimum load resistance of Range I, and will be set to Range II when the programmed load resistance is lower than the minimum load resistance of Range I.</p>
	<p><b>CV Mode</b></p> <p>Range I indicates low load voltage operating range, Range II indicates high load voltage operating range. The specification of voltage ranges is shown in section 4.1, "Operating Ranges". The voltage range is changed automatically in accordance to the programmed load voltage.</p> <p>Range I is selected automatically if the programmed load voltage is less than the maximum voltage of Range I (6V), and will be set to range II automatically when the programmed voltage is higher than the maximum voltage of Range I (6V).</p>
	<p><b>CP Mode</b></p> <p>Range I indicates low load power operating range, Range II indicates high load power operating range. The power range specification is shown in section 4.1, "Operating Ranges". The power range is changed automatically in accordance with the programmed load power.</p> <p>Range I is selected automatically if the programmed load power is less than the maximum power of Range I, and will be set to Range II automatically when the programmed power is higher than the maximum power of Range I.</p>
4	<p>The Remote LCD Indicator is used to indicate the status of remote operation. Front panel operation is locked out while the remote LCD annunciator is ON. In case of Local mode or manual operation, the Remote LCD annunciator is OFF</p>
5	<p>The 5 digit LCD display is a multi-function display, the functions are described below:</p> <p><b>Normal mode:</b></p> <p>This is a 5 digit DVM display, measuring data of the DC input terminal or V-sense input terminal if V-sense AUTO is programmed. If V-sense ON is programmed, the display shows the voltage at the V-sense input terminal only.</p> <p>When the auto-sense of V-sense function is programmed, the auto-sense circuit of the electronic load can check if the V-sense cable is connected, If the V-sense input detected is greater than 0.7V or not. If both conditions are true, the 5 digit DVM measures at the sense input (remote V sense), otherwise, the 5 digit DVM measures at the DC input terminals of the load (local V sense).</p>

Key #	Description
	<p><b>Test Setting Mode:</b></p> <p>Short: Short test Enable and Short Setting programming: Display will show: "Short".</p> <p>OPP: OPP test Enable and OPP Setting programming: Display will show: "OPP".</p> <p>OCP: OCP test Enable and OCP Setting programming: Display will show: "OCP".</p> <p>During Short, OCP and OPP test programming, this display will show sensed voltage or load Input voltage.</p>
6	<p>This readout can be in one of two modes: Normal or Setting mode.</p> <p>In "Normal" mode, this 5 digit LCD displays the measured current of the DC load when the load is ON.</p>
	<p>In "Setting" mode, this LCD displays the following setting parameters. The rotary knob is used to scroll through these settings:</p> <ol style="list-style-type: none"> <li>1. Config ON programming: Display will individually show "SENSE", "LDon", "LDoFF" and "POLAR".</li> <li>2. Limit ON programming: Display will individually show "V_Hi", "V_Lo", "A_Hi", "A_Lo", "W_Hi", "W_Lo" and "NG".</li> <li>3. DYN setting ON programming: Display will individually show "T-Hi", "T-Lo", "RISE" and "FALL".</li> <li>4. Short test Enable, OCP test Enable and OPP test Enable programming: Display will individually show [PRESS].</li> <li>5. Short setting programming: Display will individually show "TIME", "V-Hi" and "V-Lo".</li> <li>6. OPP setting programming: Display will individually show "PSTAR", "PSTEP", "PSTOP" and "VTH".</li> <li>7. OCP setting programming: Display will individually show "ISTAR", "ISTEP", "ISTOP" and "VTH".</li> <li>8. During Short testing: Display shows actual load current in "A".</li> <li>9. During OCP testing: Display shows actual load current in "A".</li> <li>10. During OPP testing: Display shows actual power in "W"</li> </ol> <p>When over current protect is tripped: Display shows [OCP].</p>
7	<p>This readout can be in one of two modes: Normal or Setting mode.</p> <p>In "Normal" mode, this 5 digit LCD displays the power dissipated by the DC load when the load is ON.</p>
	<p>In "Setting" mode, this LCD displays the following setting parameters. The rotary knob is used to scroll through these settings:</p> <ol style="list-style-type: none"> <li>1. PRESET ON mode display will individually show: <ol style="list-style-type: none"> <li>a. CC mode's current programming value display, the unit is "A"</li> <li>b. CR mode's resistor programming value display, the unit is "Ω"</li> <li>c. CV mode's voltage programming value display, the unit is "V"</li> <li>d. CP mode's power programming value display, the unit is "W"</li> </ol> </li> <li>2. LIMIT ON mode display will individually show : <ol style="list-style-type: none"> <li>a. V_Hi (upper limit voltage) &amp; V_Lo (lower limit voltage) value display, the unit is "V"</li> <li>b. A_Hi (upper limit current) &amp; A_Lo (lower limit current) value display, the unit is "A"</li> <li>c. W_Hi (upper limit power) &amp; W_Lo (lower limit power) value display, the unit is "W"</li> <li>d. NG programming display will show [ON] or [OFF]</li> </ol> </li> <li>3. DYN setting ON mode display will individually show : <ol style="list-style-type: none"> <li>a. T-Hi (level high time)&amp; T-Lo(level low time) programming value display, the unit is "ms"</li> </ol> </li> </ol>

Key #	Description
	<ul style="list-style-type: none"> <li>b. Rise/Fall current slew rate programming value display, the unit is "(m)A/us"</li> </ul> <ol style="list-style-type: none"> <li>4. Config ON mode display will individually show:               <ul style="list-style-type: none"> <li>a. SENSE programming display shows [ON] or [AUTO]</li> <li>b. LDon &amp; LDoFF value displayed, the unit are "V"</li> <li>c. Load polarity value display shows [+LOAD] or [-LOAD]</li> </ul> </li> <li>5. Short test Enable, OCP test Enable and OPP test Enable mode will show [START]</li> <li>6. Short Setting mode               <ul style="list-style-type: none"> <li>a. Short setting display will show "CONTI", Short time setting; the unit is "ms"</li> <li>b. V-Hi &amp; V-Lo value display, the unit is "V"</li> </ul> </li> <li>7. OPP Setting mode               <ul style="list-style-type: none"> <li>a. OPP PSTAR, OPP PSTEP and OPP PSTOP value display, the unit is "W"</li> <li>b. OPP Vth value display, the unit is "V".</li> </ul> </li> <li>8. OCP Setting mode               <ul style="list-style-type: none"> <li>a. OCP ISTAR, OCP ISTEP and OCP ISTOP value display, the unit is "A"</li> <li>b. OCP VTH value display, the unit is "V"</li> </ul> </li> <li>9. OCP test &amp; OPP test mode display will show [RUN]</li> <li>10. When over power protect: Display will show [OPP]</li> <li>11. When over temperature protect: Display will show [OTP]</li> </ol>
8	<p><b>MODE and CC, CR, CV, CP Indicator</b></p> <p>There are four operating modes that can be selected by pressing the "MODE" key. The sequence is Constant Current ( CC ), Constant Resistance ( CR ), Constant Voltage ( CV ), Constant Power ( CP ) and then repeats while pressing the "MODE" key. The CC, CR, CV and CP mode indicator will be lit respectively when the appropriate operating mode is selected.</p>
9	<p><b>LOAD ON/OFF key and LED</b></p> <p>The load input can be toggled ON/OFF using the front panel's LOAD ON/OFF key. The load current slew rate follows the slew rate setting, so the load current slew rate will change at the programmed Rise/Fall slew rate setting respectively.</p> <p>Turning the LOAD OFF does not affect the programmed settings. The LED is OFF to indicate LOAD OFF status. The LOAD will return to the previously programmed values when the LOAD key is turned to ON again.</p> <p>The Load ON LED indicates the load is ready to sink current from DC input.</p> <ol style="list-style-type: none"> <li>1. Load ON/OFF key: Switches from load ON to load OFF. The fall slew rate is in accordance with the slew rate setting on the front panel.</li> <li>2. DC input voltage: There is a load ON and load OFF voltage control circuit in the electronic load. When the Device under Test turns ON, the output voltage of D.U.T will increase up from 0 to rated output voltage. The electronic load will start to sink current after load voltage is higher than load ON voltage configuration setting (See "Config" key). The programmed load ON voltage for the 5P Series load is from 0.1 to 25V. When the device under test (DUT) turns OFF, the output voltage of DUT will decrease down to 0 volt. The electronic load will stop to sink current after load voltage is lower than load OFF voltage configuration setting (See "Config" key). The programmed load OFF voltage for the load is from 0 Vdc to the load ON voltage value.</li> </ol>
10	<p><b>DYN / STA key and LED</b></p> <p>This key is available in Constant Current and Constant Power mode only. In Constant Resistance and Constant Voltage mode, this key has no function and the LED is OFF. The load will default to</p>



Key #	Description
	static mode. In Constant Current and Constant Power mode, the Static or Dynamic mode is toggled by this key; the LED will be lit if the load is in Dynamic mode.
11	<p><b>RANGE key and LED</b></p> <p>Range AUTO / II Key is for range selection. If the Range AUTO LED is OFF, the load will be in Range I (low range) or II (high range) in accordance with the actual current value. When Range the II, LED is ON, the current programming will be locked on Range II (high range).</p>
12	<p><b>LEVEL key and LED</b></p> <p>In the Dynamic Constant Current mode, there is no effect to the load although the LED may indicate the High or Low level in the Static mode. The only fact is switching the load from Dynamic load to Static load.</p> <ol style="list-style-type: none"> <li>In Constant Current mode: The level is initially set to High. LEVEL High / Low has two levels, Low current level setting must be lower than Level High.</li> <li>In Constant Resistance mode: The level is initially set to High. LEVEL High / Low has two levels, Low resistance level setting must be higher than Level High. <b>Note:</b> CR Mode Level High / Low level by current perspectives.</li> <li>In Constant Voltage mode: The level is initially set to High. LEVEL High / Low has two levels, Low voltage level setting must be lower than Level High. <b>Note:</b> CV Mode Level High / Low has "automatic push function."</li> <li>In Constant Power mode: The level is initially set to High. LEVEL High / Low has two levels, Low power level setting must be lower than Level High.</li> </ol> <p><b>Note:</b> Automatic push function: The Level High setting must be higher or equal than Level Low setting. When Level High is equal to LEVEL Low, it cannot be adjusted anymore. When Level High equals Level Low, the Automatic push function will adjust the Level Low value so the Level High value can continue to be adjusted.</p>
13	<p><b>PRESET ON/OFF key and LED</b></p> <p>In Preset OFF state, the load input voltage is shown on the right hand side 5-digit meter, and load input current is shown on the middle 5-digit meter. The load input power is shown on the left hand side 5-digit meter. The engineering unit "V", "A" and "W" LCDs will be lit respectively.</p> <p>In Preset ON state, the PRES. LED is ON, the left hand side 5-digit meter display will be determined by the CC, Dynamic, CR, CV, and CP operating mode.</p> <p>In Preset ON condition, the 5 digit DAM indicates the set load current, which can be from front panel or remote control interface setting.</p> <ol style="list-style-type: none"> <li>In Constant Current mode: The High / Low level load current value can be preset on the left hand side 5 digit LCD display. The unit is "A" and the "A" will be lit as well.</li> <li>In Dynamic load mode: The Thigh / Tlow parameters value of High / Low load current duration and Rise / Fall setting can be displayed on the left hand side 5 digit LCD display. The unit is "ms" and the "ms" will be lit as well.</li> <li>In Constant Resistance mode: The High / Low level load resistance value can be preset on the left hand side 5 digit LCD display. The engineering unit is "Ω" and the "Ω" will be lit as well.</li> <li>In Constant Voltage mode: The High / Low level load voltage value can be preset on the right hand side 5 digit LCD display. The unit is "V" and the "V" will be lit as well.</li> <li>In Constant Power mode: The High / Low level load power value can be preset on the right hand side 5 digit LCD display. The unit is "W" and the "W" will be lit as well.</li> </ol>









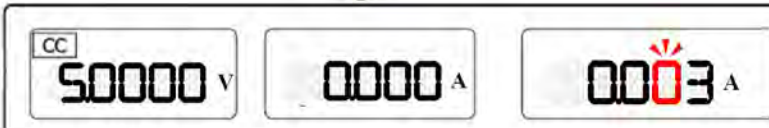

Key #	Description
14	<p><b>LIMIT key and LED</b></p> <p>The Limit key setting includes the GO/NG check of digital voltage meter Upper/Lower limit, current meter Upper/Lower limit, and watt meter Upper/Lower limit within the Limit key setting. The setting sequence is shown below:</p> <p>OFF → DVM Upper/Lower limit → DAM Upper/Lower limit → DWM Upper/Lower limit → GO/NG check ON/OFF → OFF → Repeat</p>
15	<p><b>DYN setting key and LED</b></p> <p>DYN setting key is to set the Dynamic Mode parameters. They are rise, fall, Thigh and Tlow. Parameters can be changed using the rotary knob. Press any key to escape the DYN parameter setting mode.</p> <ol style="list-style-type: none"> <li>1. Press DYN setting key, LED will turn ON</li> <li>2. Setting level High Period: Middle 5 digit LCD display will show "T-Hi", left 5 digit LCD display will show setting value. The unit is "ms"</li> <li>3. Setting level Low period: Middle 5 digit LCD display will show "T-Lo", left 5 digit LCD display will show setting value. The unit is "ms"</li> <li>4. Setting rise time: Middle 5 digit LCD display will show "RISE", left 5 digit LCD display will show setting value. The unit is "(m)A/us"</li> <li>5. Setting fall time: Middle 5 digit LCD display will show "FALL", left 5 digit LCD display will show setting value. The unit is "(m)A/us"</li> </ol>
16	<p><b>CONFIG key and LED</b></p> <p>The Config key setting includes the Sense AUTO/ON, Load ON/OFF voltage and Load Polarity. The setting sequence is shown below.</p> <p>OFF → SENSE AUTO/ON → Load ON/OFF Voltage → Polarity setting → OFF → Repeat</p>
17	<p><b>SHORT key and LED Functions</b></p> <ol style="list-style-type: none"> <li>1. Short test function Enable/Disable Key: Press the "SHORT" key to enable the short test function. The indicator LED will be lit. The LCD display shows "SHORT" on the right hand side 5-digit LCD display, shows "PRESS" on the middle 5-digit LCD display and shows "START" on the left hand side 5-digit LCD display.</li> <li>2. Short test function parameter setting key: There are three parameters for the SHORT test function. The parameters are: TIME, V-Hi and V-Lo. Press the "SHORT" key again to set short test time when the SHORT test function is enabled. Press SHORT key again to proceed to the next parameter and follow the sequence of TIME, V-Hi, V-Lo and Disable. Press any another key to exit and save the SHORT settings. The SHORT test parameter descriptions are as follows: <ol style="list-style-type: none"> <li>a. TIME: Setting the short test time. The LCD display shows "SHORT", "TIME" and CONT (or initial setup value) on the right to left 5-digit LCD displays. The setting range is "CONTI" which means continuous or 100ms to 10000ms in 100ms steps. Turn the rotary knob clockwise to adjust this the setting. The short test will have no time limitation when set to "CONTI" until the "START/STOP" key is pressed to stop the short test.</li> <li>b. V-Hi: Short test voltage check upper limitation setting. The LCD displays show "SHORT", "V-Hi" and 0.00V (or initial setup value) from right to left. The V-Hi setting</li> </ol> </li> </ol>

Key #	Description
	<p>range is from 0.00 to 60.00V in 0.01V steps and can be adjusted by turning the rotary knob.</p> <p>c. V-Lo: Short test voltage check lower limitation setting. The LCD displays show "SHORT", "V-Lo" and 0.00V (or initial setup value) from right to left. The V-Lo setting range is from 0.00 to 60.00V in 0.01V steps and can be adjusted by turning the rotary knob.</p> <p><b>Note:</b> The V-Hi and V-Lo parameters of the SHORT test are different from the V-Hi and V-Lo settings of the LIMIT function.</p> <p>3. START/STOP Test key. Press the "START/STOP" key to start or stop the SHORT test when SHORT test function is enabled. The Load will go to "ON" state automatically when the "START/STOP" key is pressed and start the SHORT test. The Load will go to "OFF" state automatically when the "START/STOP" key is pressed to stop the short test. However, the Load will stay in the "ON" state if the load was "ON" before SHORT test execution. The SHORT test function is used to the UUT's short circuit protection function. The SHORT test will sink the load's full scale current until the UUT's voltage drop is between the set V<sub>Hi</sub> and V<sub>Lo</sub> limits. The left hand side 5-digit LCD display will shows "PASS", otherwise it will show "FAIL". Press any key to return to normal mode LCD display.</p>
18	<p><b>OCP key and LED Functions</b></p> <ol style="list-style-type: none"> <li>1. OCP test function Enable/Disable Key. Press the "OCP" key to enable the OCP test function and the indicator LED will be lit. The LCD display shows "OCP" on right 5-digit LCD display, shows "PRESS" on the middle 5-digit LCD display and shows "START" on left 5-digit LCD display.</li> <li>2. OCP test function parameter settings. There are four parameters for the OCP test function. These parameters are: ISTAR, ISTEP, ISTOP and Vth. Press the "OCP" key again to set the OCP test parameter ISTAR(start current point) Press the "OCP" key again to proceed to the next parameter in order of ISTEP, ISTOP, Vth and Disable. Press any another key to exit the and save the OCP settings. The OCP test parameter descriptions are as follows: <ol style="list-style-type: none"> <li>a. ISTAR: Setting the start current point. The LCD display shows "OCP", "ISTAR" and 0.000A (or initial setup value) from right to left on the 5-digit LCD displays. The setting range is 0.000A to the full scale of the CC mode specification. This parameter can be adjusted by turning the rotary knob.</li> <li>b. ISTEP: Setting the increment current step size. The LCD display shows "OCP", "ISTEP" and 0.000A (or initial setup value) from right to left on the 5-digit LCD displays. The setting range is 0.000A to the full scale of the CC mode specification. This parameter can be adjusted by turning the rotary knob.</li> <li>c. ISTOP: Setting the stop current point. The LCD display shows "OCP", "ISTOP" and 120.0A (actual value depends on 5P Series model) from right to left on the 5-digit LCD displays. The setting range is 0.000A to the full scale of the CC mode specification. This parameter can be adjusted by turning the rotary knob.</li> <li>d. Vth: Setting the threshold voltage. The LCD display shows "OCP", "Vth" and 0.50V (or initial setup value) from right to left on the 5-digit LCD displays. The setting range is 0.00V to the full scale of the Voltage specification. This parameter can be adjusted by</li> </ol> </li> </ol>

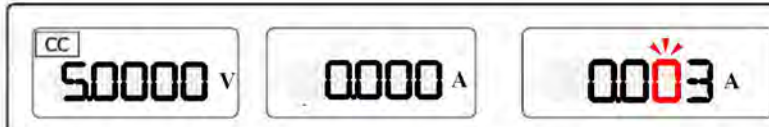

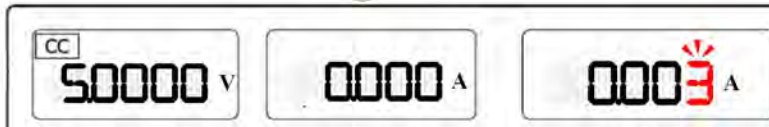
Key #	Description
	<p>turning the rotary knob.</p> <p>3. START/STOP Test key. Press START/STOP key to start or stop the OCP when the OCP test function is enabled. The Load will go to the "ON" state automatically when the "START/STOP" key is pressed and start the OCP test. The load will return to the "OFF" state automatically when the "START/STOP" key is pressed to stop the OCP test. The load will remain in the "ON" state if the load was "ON" before OCP test execution. The OCP test function tests the UUT's over current protection function. The OCP test will start sinking current from I-START and increase by ISTEP current until the UUT's output voltage drops below the threshold voltage(V-th setting), and the OCP trip point is between the A_Hi and A_Lo limit settings. The left hand side 5- digits LCD display will shows "PASS", otherwise it will show "FAIL". Press any key to return to normal mode LCD display.</p>
19	<p><b>OPP key and LED Functions</b></p> <p>1. OPP test function Enable/Disable Key. Press the "OPP" key to enable the OPP test function and the indicator LED will be lit. The LCD display show "OPP" on right 5 left LCD display, shows "PRESS" on middle 5-digit LCD display and shows "START" on the left hand side 5-digit LCD display.</p> <p>2. OPP test function parameter setting key. There are four parameters for the OPP test function. These parameters are: PSTAR, PSTEP, PSTOP and Vth. Press the "OPP" key again to set the OPP test parameter PSTAR (start power point). Press the "OPP" key again to proceed to the next parameter in order of PSTEP, PSTOP, Vth and Disable. Press any other key to exit and save the OPP setting. The OPP test parameter descriptions are as follows:</p> <ul style="list-style-type: none"> <li>a. PSTAR: setting the start power, The LCD display shows "OPP", "PSTAR" and 0.00W (or initial setup value) from right to left 5 digits LCD display, the setting range is 0.00W to the full scale of the CP mode specification. The setting is by rotating the setting knob.</li> <li>b. STEP: setting the increment step power, The LCD display shows "OPP", "PSTEP" and 0.00W (or initial setup value) from right to left 5 digits LCD display, the setting range is 0.00W to the full scale of the CP mode specification. The setting is by rotating the setting knob.</li> <li>c. PSTOP: setting the stop power, The LCD display shows "OPP", "PSTOP" and 1200.0W (or initial setup value) from right to left 5 digits LCD display, the setting range is 0.00W to the full scale of the CP mode specification. The setting is by rotating the setting knob.</li> <li>d. Vth: Setting threshold voltage; The LCD display shows "OPP", "Vth" and 0.50V (or initial setup value) from right to left 5 digits LCD display, the setting range is 0.00V to the full scale of the Voltage specification. The setting is by rotating the setting knob.</li> </ul> <p>3. START/STOP Test key. Press START/STOP key to start or stop the OPP test when the OPP test function is enabled. The load will go to the "ON" state automatically when the "START/STOP" key is pressed and start the OPP test. The load will return to the "OFF" state automatically when the "START/STOP" key is pressed to stop the OPP test. The load will remain in the "ON" state if the load was "ON" before OPP test execution. The OPP test function tests the UUT's over power protection function. The OPP test will</p>

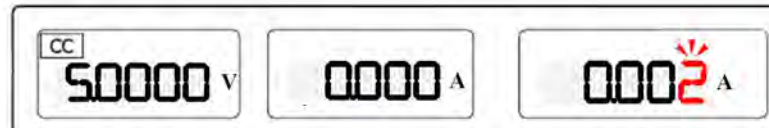
Key #	Description																		
	<p>start sinking current from PSTART and increase power by PSTEP until the UUT's output voltage drops below the threshold voltage (V-th setting), and the OPP trip point is between the P_Hi and P_Lo limit settings. The left hand side 5- digits LCD display will shows "PASS", otherwise it will show "FAIL". Press any key to return to normal mode LCD display.</p>																		
<b>20</b>	<p><b>START/STOP key Operation</b></p> <ol style="list-style-type: none"> <li>1. Press START/STOP key to start or stop the short test by SHORT, OCP &amp; OPP test setting parameter when SHORT, OCP &amp; OPP test function is enabled.</li> <li>2. The load will go to "ON" automatically when pressing the "START/STOP" key to start the short test and the load will go to "OFF" automatically when pressing the "START/STOP" key to stop the short test. The load will stay to "ON" If it was "ON" before short test.</li> <li>3. The SHORT, OCP &amp; OPP test functions are used to test the circuit protection of a unit under test. These tests will sink the load's maximum current or power to apply the test condition. If the UUT's voltage drop is between the V_Hi and V_Lo limits programmed, the lower 5-digit LCD display will shows "PASS", otherwise it will show "FAIL". Press any key to return to normal mode LCD display.</li> </ol>																		
<b>21</b>	<p>Rotary Shuttle Knob</p> <p>Right Knob: Adjust flash digit value clockwise to increase set value.</p> <div style="display: flex; align-items: center;">  <div style="border: 1px solid black; padding: 5px; width: 100%;"> <table style="width: 100%; border-collapse: collapse;"> <tr> <td style="border: 1px solid black; padding: 5px; text-align: center;">CC 50000 V</td> <td style="border: 1px solid black; padding: 5px; text-align: center;">0000 A</td> <td style="border: 1px solid black; padding: 5px; text-align: center;">000<sup>2</sup> A</td> </tr> <tr style="text-align: center;"> <td colspan="3">↓</td> </tr> <tr> <td style="border: 1px solid black; padding: 5px; text-align: center;">CC 50000 V</td> <td style="border: 1px solid black; padding: 5px; text-align: center;">0000 A</td> <td style="border: 1px solid black; padding: 5px; text-align: center;">000<sup>3</sup> A</td> </tr> </table> </div> </div> <p>Right Knob: Adjust flash digit value counter-clockwise to increase set value.</p> <div style="display: flex; align-items: center;">  <div style="border: 1px solid black; padding: 5px; width: 100%;"> <table style="width: 100%; border-collapse: collapse;"> <tr> <td style="border: 1px solid black; padding: 5px; text-align: center;">CC 50000 V</td> <td style="border: 1px solid black; padding: 5px; text-align: center;">0000 A</td> <td style="border: 1px solid black; padding: 5px; text-align: center;">000<sup>3</sup> A</td> </tr> <tr style="text-align: center;"> <td colspan="3">↓</td> </tr> <tr> <td style="border: 1px solid black; padding: 5px; text-align: center;">CC 50000 V</td> <td style="border: 1px solid black; padding: 5px; text-align: center;">0000 A</td> <td style="border: 1px solid black; padding: 5px; text-align: center;">000<sup>2</sup> A</td> </tr> </table> </div> </div>	CC 50000 V	0000 A	000 <sup>2</sup> A	↓			CC 50000 V	0000 A	000 <sup>3</sup> A	CC 50000 V	0000 A	000 <sup>3</sup> A	↓			CC 50000 V	0000 A	000 <sup>2</sup> A
CC 50000 V	0000 A	000 <sup>2</sup> A																	
↓																			
CC 50000 V	0000 A	000 <sup>3</sup> A																	
CC 50000 V	0000 A	000 <sup>3</sup> A																	
↓																			
CC 50000 V	0000 A	000 <sup>2</sup> A																	

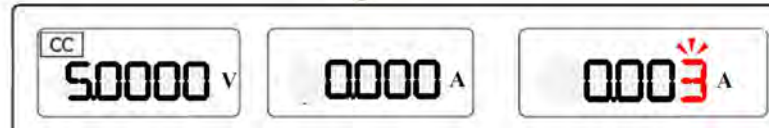
Key #	Description
	<p>Left Cursor key: Moves the flashing digit over to the left by one position.</p>    
	<p>Right Cursor key: Moves the flashing digit over to the right by one position.</p>    
	<p>Up Cursor key: Increments flashing digit setting value by one count.</p>    

Key #	Description
	<p>Down Cursor key: Decrements flashing digit setting value by one count.</p>
	<p>NOTE:</p> <ul style="list-style-type: none"> <li>In CR MODE, the Right and Up Cursor keys decrease setting value.</li> <li>In CR MODE, the Left and Down Cursors keys increase setting value.</li> </ul>

Table 6-1: Front Panel Display and Keyboard Functions

### 6.3 Shuttle Adjustment Resolution by Model

The shuttle may be used to increment or decrement setting values in either preset or real-time mode. The amount of adjustment depends on the parameter being adjusted as well as the available adjustment range. Since ranges vary by model number, the following tables provide a reference of resolutions and step size by model, function and range.

#### 6.3.1 Model 5P024-24 Shuttle Knob Adjustments

5P024-24		RANGE I			RANGE II		
FULL SCALE LOAD CURRENT		24 A			240 A		
CURRENT	RANGE	0 - 24A/240A					
METER	RESOLUTION	0.4mA/4mA					
COURSE/FINE LOAD CURRENT ADJUSTMENT knob							
CC Mode		100mA	10mA	0.8mA	1000mA	100mA	8mA
CR Mode		6.66mS	0.666mS	0.0666mS	0.41mΩ	0.041mΩ	0.0041mΩ
CV Mode		0.01V	0.001V	0.0001V	0.1V	0.01V	0.001V
CP Mode		1W	0.1W	0.008W	10W	1W	0.08W

#### 6.3.2 Model 5P024-48 Shuttle Knob Adjustments

5P024-48	RANGE I			RANGE II	
----------	---------	--	--	----------	--

FULL SCALE LOAD CURRENT		48 A			480 A	
CURRENT	RANGE	0 - 48A/480A				
METER	RESOLUTION	0.8mA/8mA				
COURSE/FINE LOAD CURRENT ADJUSTMENT knob						
CC Mode	100mA	10.4mA	0.8mA	1000mA	104mA	8mA
CR Mode	13.33mS	1.333mS	0.1333mS	0.2mΩ	0.02mΩ	0.002mΩ
CV Mode	0.01V	0.001V	0.0001V	0.1V	0.01V	0.001V
CP Mode	1W	0.10W	0.008W	10W	1W	0.08W

### 6.3.3 Model 5P036-24 Shuttle Knob Adjustments

5P036-24		RANGE I			RANGE II	
FULL SCALE LOAD CURRENT		24 A			240 A	
CURRENT	RANGE	0 - 24A/240A				
METER	RESOLUTION	0.4mA/4mA				
COURSE/FINE LOAD CURRENT ADJUSTMENT knob						
CC Mode	100mA	10mA	0.8mA	1000mA	100mA	8mA
CR Mode	6.66mS	0.666mS	0.0666mS	0.41mΩ	0.041mΩ	0.0041mΩ
CV Mode	0.01V	0.001V	0.0001V	0.1V	0.01V	0.001V
CP Mode	1.002W	0.102W	0.006W	10.02W	1.02W	0.06W

### 6.3.4 Model 5P036-48 Shuttle Knob Adjustments

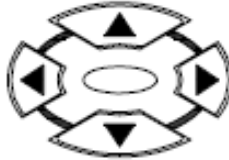
5P036-48		RANGE I			RANGE II	
FULL SCALE LOAD CURRENT		48 A			480 A	
CURRENT	RANGE	0 - 48A/480A				
METER	RESOLUTION	0.8mA/8mA				
COURSE/FINE LOAD CURRENT ADJUSTMENT knob						
CC Mode	100mA	10.4mA	0.8mA	1000mA	104mA	8mA
CR Mode	13.33mS	1.333mS	0.1333mS	0.2mΩ	0.02mΩ	0.002mΩ
CV Mode	0.01V	0.001V	0.0001V	0.1V	0.01V	0.001V
CP Mode	1.002W	0.102W	0.006W	10.02W	1.02W	0.06W

### 6.3.5 Model 5P036-72 Shuttle Knob Adjustments

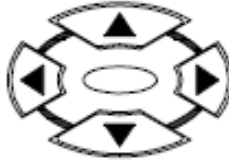
5P036-72		RANGE I			RANGE II	
FULL SCALE LOAD CURRENT		72 A			720 A	
CURRENT	RANGE	0 - 72A/720A				
METER	RESOLUTION	1.2mA/12mA				
COURSE/FINE LOAD CURRENT ADJUSTMENT knob						
CC Mode	100.8mA	10.8mA	1.2mA	1008mA	108mA	12mA
CR Mode	20mS	2mS	0.2mS	0.13mΩ	0.013mΩ	0.0013mΩ
CV Mode	0.01V	0.001V	0.0001V	0.1V	0.01V	0.001V
CP Mode	1.002W	0.102W	0.006W	10.02W	1.02W	0.06W

### 6.3.6 Model 5P054-36 Shuttle Knob Adjustments

5P054-36		RANGE I			RANGE II		
FULL SCALE LOAD CURRENT		36 A			360 A		
CURRENT	RANGE	0 - 36A/360A					
METER	RESOLUTION	0.6mA/6mA					
COURSE/FINE LOAD CURRENT ADJUSTMENT knob							
CC Mode		100.2mA	10.2mA	0.6mA	1002mA	102mA	6mA
CR Mode		10mS	1mS	0.1mS	0.27mΩ	0.027mΩ	0.0027mΩ
CV Mode		0.01V	0.001V	0.0001V	0.1V	0.01V	0.001V
CP Mode		1.008W	0.108W	0.009W	10.08W	1.08W	0.09W

### 6.3.7 Model 5P054-99 Shuttle Knob Adjustments

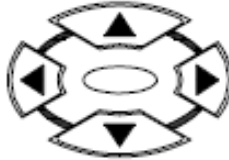
5P054-99		RANGE I			RANGE II		
FULL SCALE LOAD CURRENT		100 A			1000 A		
CURRENT	RANGE	0 - 100A/1000A					
METER	RESOLUTION	1.67mA/16.7mA					
COURSE/FINE LOAD CURRENT ADJUSTMENT knob							
CC Mode		100.02mA	10.002mA	1.667mA	1000.2mA	100.02mA	16.67mA
CR Mode		27.77mS	2.777mS	0.2777mS	0.1mΩ	0.01mΩ	0.001mΩ
CV Mode		0.01V	0.001V	0.0001V	0.1V	0.01V	0.001V
CP Mode		1.008W	0.108W	0.009W	10.08W	1.08W	0.09W

### 6.3.8 Model 5P072-48 Shuttle Knob Adjustments

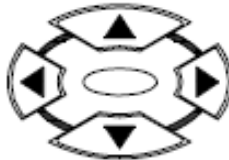
5P072-48		RANGE I			RANGE II		
FULL SCALE LOAD CURRENT		48 A			480 A		
CURRENT	RANGE	0 - 48A/480A					
METER	RESOLUTION	0.8mA/8mA					
COURSE/FINE LOAD CURRENT ADJUSTMENT knob							
CC Mode		100mA	10.4mA	0.8mA	1000mA	100.4mA	8mA
CR Mode		13.33mS	1.333mS	0.1333mS	0.2mΩ	0.02mΩ	0.002mΩ
CV Mode		0.01V	0.001V	0.0001V	0.1V	0.01V	0.001V
CP Mode		1.008W	0.108W	0.012W	10.08W	1.08W	0.12W

### 6.3.9 Model 5P072-96 Shuttle Knob Adjustments

5P072-96		RANGE I			RANGE II		
FULL SCALE LOAD CURRENT		96 A			960 A		
CURRENT	RANGE	0 - 96A/960A					
METER	RESOLUTION	1.6mA/16mA					
COURSE/FINE LOAD CURRENT ADJUSTMENT knob							
CC Mode		100.8mA	11.2mA	1.6mA	1008mA	112mA	16mA
CR Mode		26.66mS	2.666mS	0.2666mS	0.1mΩ	0.01mΩ	0.001mΩ
CV Mode		0.01V	0.001V	0.0001V	0.1V	0.01V	0.001V
CP Mode		1.008W	0.108W	0.012W	10.08W	1.08W	0.12W

### 6.3.10 Model 5P090-60 Shuttle Knob Adjustments

5P090-60		RANGE I			RANGE II		
FULL SCALE LOAD CURRENT		60 A			600 A		
CURRENT	RANGE	0 - 60A/600A					
METER	RESOLUTION	1mA/10mA					
COURSE/FINE LOAD CURRENT ADJUSTMENT knob							
CC Mode		100mA	10mA	1mA	1000mA	100mA	10mA
CR Mode		16.66mS	1.666mS	0.1666mS	0.16mΩ	0.016mΩ	0.0016mΩ
CV Mode		0.01V	0.001V	0.0001V	0.1V	0.01V	0.001V
CP Mode		1.005W	0.105W	0.015W	10.05W	1.05W	0.15W

### 6.3.11 Model 5P108-72 Shuttle Knob Adjustments

5P108-72		RANGE I			RANGE II		
FULL SCALE LOAD CURRENT		72 A			720 A		
CURRENT	RANGE	0 - 72A/720A					
METER	RESOLUTION	1.2mA/12mA					
COURSE/FINE LOAD CURRENT ADJUSTMENT knob							
CC Mode		100.8mA	10.8mA	1.2mA	1008mA	108mA	12mA
CR Mode		20mS	2mS	0.2mS	0.13mΩ	0.013mΩ	0.0013mΩ
CV Mode		0.01V	0.001V	0.0001V	0.1V	0.01V	0.001V
CP Mode		10.008W	1.008W	0.09W	100.08W	10.08W	0.9W



### 6.3.12 Model 5P126-84 Shuttle Knob Adjustments

5P126-84		RANGE I			RANGE II		
FULL SCALE LOAD CURRENT		84 A			840 A		
CURRENT	RANGE	0 - 84A/840A					
METER	RESOLUTION	1.4mA/14mA					
COURSE/FINE LOAD CURRENT ADJUSTMENT knob							
CC Mode		100.8mA	11.2mA	1.4mA	1008mA	112mA	14mA
CR Mode		23.34mS	2.334mS	0.2334mS	0.11mΩ	0.011mΩ	0.0011mΩ
CV Mode		0.01V	0.001V	0.0001V	0.1V	0.01V	0.001V
CP Mode		10.017W	1.008W	0.084W	100.17W	10.08W	0.84W

### 6.3.13 Model 5P144-96 Shuttle Knob Adjustments

5P144-96		RANGE I			RANGE II		
FULL SCALE LOAD CURRENT		96 A			960 A		
CURRENT	RANGE	0~96A/960A					
METER	RESOLUTION	1.6mA/16mA					
COURSE/FINE LOAD CURRENT ADJUSTMENT knob							
CC Mode		100.8mA	11.2mA	1.6mA	1008mA	112mA	16mA
CR Mode		26.66mS	2.666mS	0.2666mS	0.1mΩ	0.01mΩ	0.001mΩ
CV Mode		0.01V	0.001V	0.0001V	0.1V	0.01V	0.001V
CP Mode		10.008W	1.008W	0.096W	100.08W	10.08W	0.96W

### 6.4 Bottom LCD Display

The LCD display located along the bottom of the load will illuminate fully when power is applied. Please refer to the relevant section number below for a brief description of the information displayed.

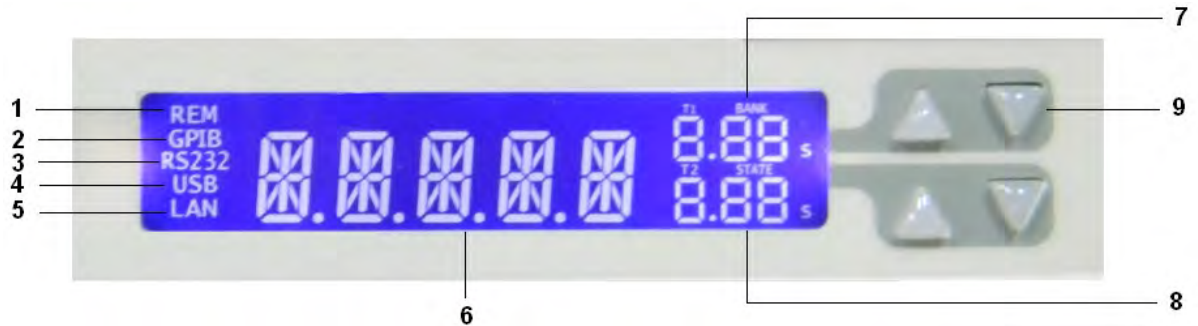

#	Displays	Description
1	Remote State	The REM annunciator will be lit when load is being controlled via the GPIB/RS232/USB or LAN -Interface. To bring back the unit to front panel control, the <b>LOCAL</b> button on the right hand side of the mainframe can be pressed
2	GPIB Installed	The GPIB annunciator will be permanently lit if the GPIB Interface option is detected.
3	RS232 Installed	The RS232 annunciator will be permanently lit if the RS232 Interface option is detected.
4	USB Installed	The USB annunciator will be permanently lit if the USB Interface option is detected.
5	LAN Installed	The LAN annunciator will be permanently lit if the LAN Interface option is detected.
6	Status Display	At power up, the LCD will display "Nor" which indicates NORMAL operation. The message displayed will change if a setting such as WAKE-UP or AUTO-SEQUENCE is selected.

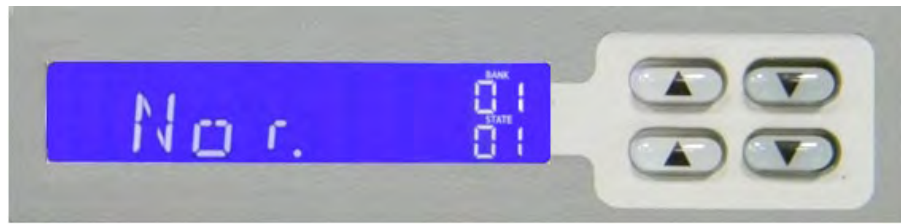

#	Displays	Description
7	BANK T1 / Display	<p>The upper digits on the right hand side of the screen relate to the memory BANK in normal mode. There are 15 BANKS which can be selected in turn by pressing the upper pair of arrow keys. Each BANK has 10 separate memory STATES (locations) which are selected with the lower pair of arrow keys.</p> <p>When in auto-sequence mode, T1 is displayed. T1 is the test time. The test time can be adjusted using the upper arrow keys between 0.1sec and 9.9sec in 100ms steps. Please note that during the T1 test time, the mainframe LCD will not flag "NG". The T2 setting is used for checking the no-go (NG) function according to the voltage, current or power limits set in the LIMIT menu.</p>
8	STATE / T2 Display	<p>The lower digits relate to the memory STATE (location) in normal mode. There are 10 memory STATES (locations) which can be selected in turn by pressing the Lower arrow keys. These memory STATES are supplemented by the 15 memory BANKS, giving the user a total of 150 memory locations.</p> <p>When in auto-sequence mode the T2 function is displayed. T2 is the time that NG/GO is checked according to the LIMITS that have been set for that test step. So if the NG flag has been enabled and the load measures values outside the preset LIMIT values, then the test will stop during T2. The mainframe's LCD will flash "NG" and the test will stop at that step in the auto-sequence. At this point, the user can either press the ENTER key to carry on to the next step or the EXIT key to abort the auto-sequence.</p>
9	Arrow Buttons	The ARROW keys are used to increase or decrease setting values.

*Table 6-2: Memory Bank LCD Display and Selection Keys*

## 6.5 Bottom Keypad Description

This paragraph covers the keypad located on along the bottom of the chassis' front panel. Please refer to the relevant section number below for a brief description of the purpose for each key.



#	Key	Description
1	EXIT, TEST, ENTER and EDIT	The 4 buttons marked EXIT, TEST, ENTER and EDIT are used to set and execute an auto-sequence.
2	1 - 10	The numbered buttons 1 through 10 are the memory states (locations) for storing or recalling a load set up. They are also used to select a previously saved auto-sequence when in test mode.
3	SYSTEM	Pressing the system button once allows the GPIB address to be changed by using the arrow keys. Pressing the system button again allows the RS232 baud rate to be adjusted. With the third press of the system button the buzzer can be switched On/Off. Another press puts the LCD back to the Normal state as shown below.
		
4	LOCAL	The local button is used to exit the remote mode and bring the unit back to front panel control
5	STORE	The store button is used to save the load configuration.
6	WAKE UP	The wake up button is used to recall the load configuration at mains power on.

Table 6-3: Memory Bank Control Keypad

## 6.6 Setting System Parameters

The SYSTEM button allows the setting for GPIB address, RS232 and Buzzer mode.

### GPIB Settings

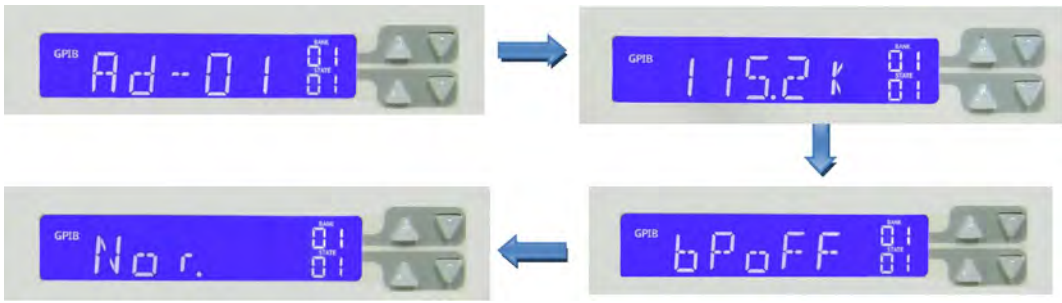
To set the GPIB address, you must press the SYSTEM key once. The LCD will display the current address. The arrow keys are used to change the address. Once the required address is reached, press the ENTER or STORE button to save the new address. The exit key can be pressed to return to the normal screen.

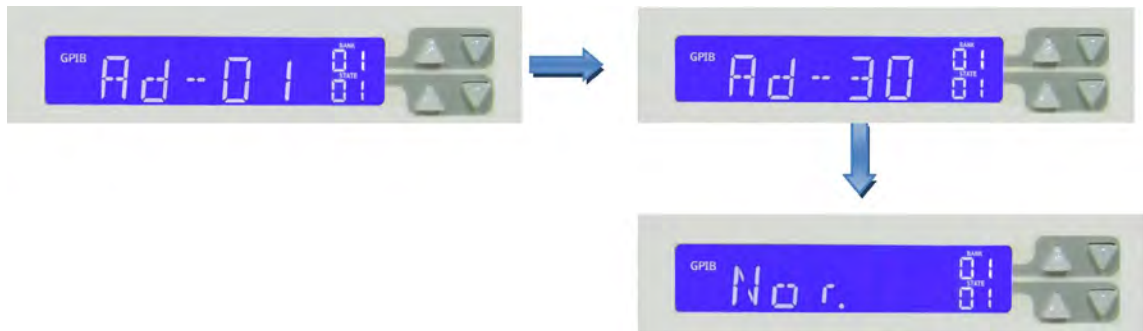

### RS232 Settings

To set the RS232 baud rate you must press the SYSTEM key twice. The LCD will display the current baud rate. The upper arrow keys are used to change the baud rate. Once the required value is reached, press ENTER or STORE button to save the new setting. The EXIT key can be pressed to return to the normal screen.

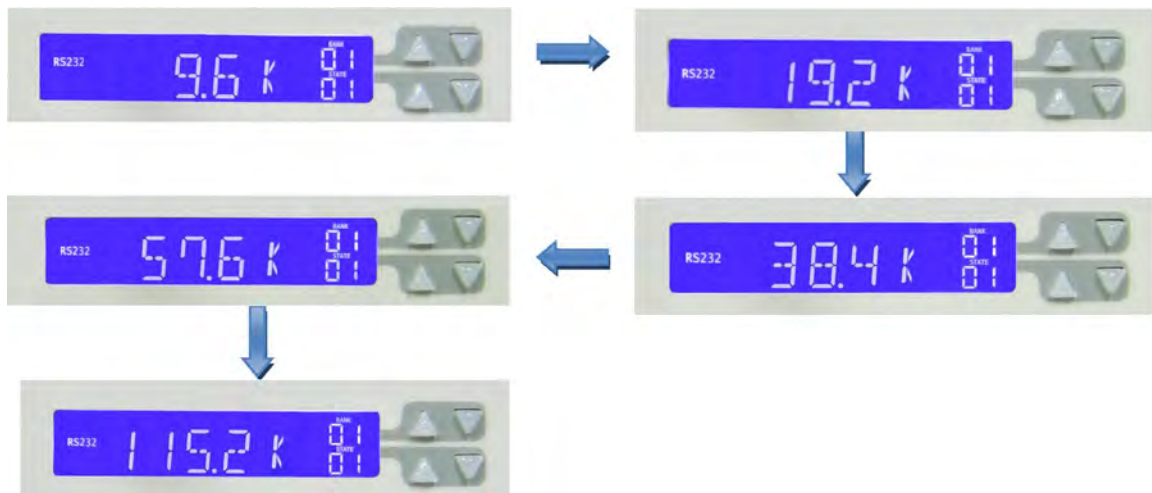

### Buzzer Settings

To set the buzzer on/off you need to press the SYSTEM key 3 times. The arrow key is used to change the buzzer state. The buzzer is used to signal that an automatic sequence has ended or failed. To save the setting press ENTER or STORE.

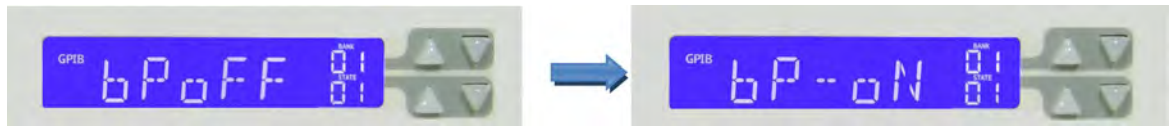

### USB and LAN Settings

Refer to section 9, “USB Driver Installation” and section 10, “LAN Driver Installation” respectively for driver information.

## 6.7 Settings STORE/RECALL Operation

The function keys on the front panel of the load are used to STORE or RECALL up to 10 electronic load STATES. Each state can contain up to 15 BANKS for setup data for a total of 150 electronic load settings. Each setting can store a variety of electronic load status and settings.

### 6.7.1 Storing a Load Setup

To store a new load setting from the front panel, proceed as follows:

1. Adjust the desired electronic load module to desired status and settings.
2. With the UP and DOWN keys, select the bank (1 to 15) in which you want to store the set up.
3. Press the store key. The store key starts flashing. (If you no longer wish to store a setting, you can press the EXIT button or wait about 20 seconds for the unit to automatically exit the store operation).
4. While the STORE light is flashing, press one of the number keys (1 to 10) where the set-up is to be saved. The STORE light will go out and the numbered key pressed will stay illuminated. This indicates the set-up has been saved to that location.

### 6.7.2 Recalling a Load Setup

To recall a load setting from the front panel, proceed as follows:

1. First select the memory bank by using the UP and DOWN arrow buttons.
2. Pressing one of the numbered STATE buttons will recall the previously saved load configuration.
3. The electronic load will immediately switch to the previously saved set-up changing the load values, operation mode and limits accordingly.

## 6.8 WAKE-UP Function

The wake up function automatically recalls a setting at mains power on. To use this feature, proceed as follows:

1. Press WAKE UP once or twice so that message SET is displayed on the bottom LCD display.



2. Select the memory location (BANK and STATE) that is to be used at power on. Once the correct location has been selected, press the STORE key. The example below shows BANK 01 STATE 01. After pressing the STORE key, the LCD will revert to the normal (Nor) message.



3. Use the mains switch on the front panel to power down the unit.
4. At mains power on the unit will automatically recall the previously saved set-up from the selected memory location.
5. To clear the settings, press the WAKE UP key once or twice so that the LCD shows clear. Now press the STORE key to cancel the previously set WAKE UP function.





## 6.9 AUTO-SEQUENCING

An auto-sequence allows the user to step through previously saved set-ups stored in the mainframe's memory. Up to 9 auto-sequences can be saved. Each auto-sequence can consist of up to 16 steps. There are two modes in the auto-sequence function:

- EDIT mode
- TEST mode

### 6.9.1 AUTO-SEQUENCE – EDIT MODE

To create a new auto-sequence or edit an existing one, proceed as follows:

1. Press the EDIT key.
2. The EDIT button will become lit and the LCD will display "FX-XX". This field is made up as follows:
  - a. The "FX" part indicates the auto-sequence number (F1 to F9 are possible). The numbered STATE keys are used to select the auto-sequence number.
  - b. The "XX" part is the test step. (1 through 16)

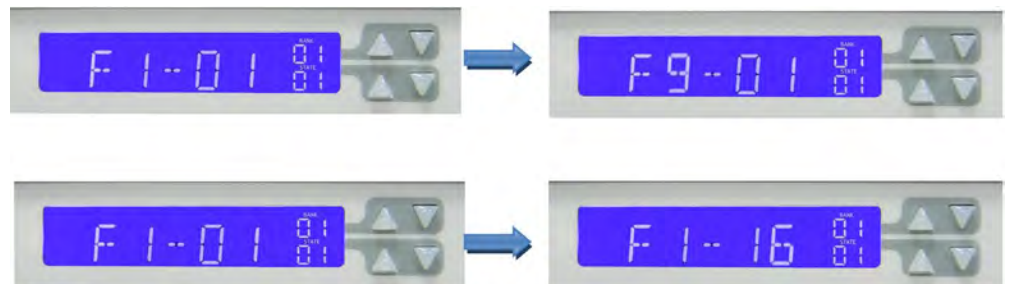

3. Once the auto-sequence number is selected, the memory location of the first test step can be selected. The arrow keys next to the bottom LCD are used to select the memory BANK and STATE. Once the desired location has been selected, press ENTER.
4. Next the total test time for that step (T1+T2) can be entered. T1 is the test time without checking the NG/LIMIT settings. T2 is the test time where if NG is ON the LIMIT settings will be checked. The upper arrow keys are used to set T1 and the lower arrow keys are used to set T2. The time setting can be adjusted in the range of 0.1s to 9.9s in 100ms increments. Please refer to Table 4 for a definition of T1 and T2.



5. Press ENTER to set the next setting step. Repeat the same process for each setting steps. Up to 16 steps can be entered. Once the T1 and T2 settings have been

entered for the final step press the STORE button. The LCD will now show REP.

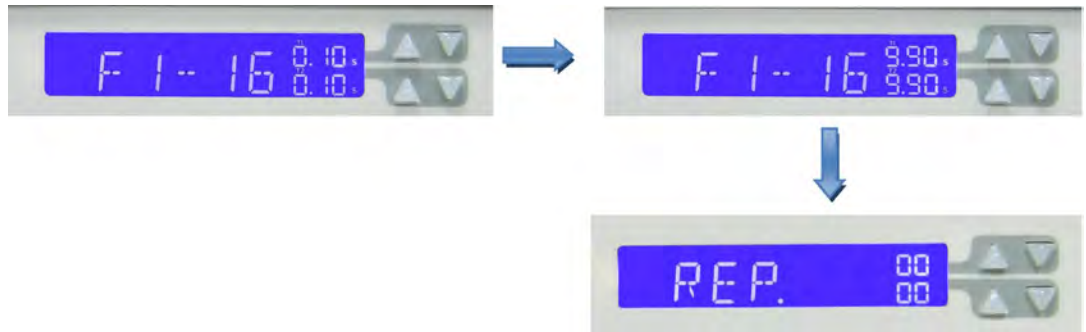

- The REP function allows the auto-sequence to be repeated a number of times. Both sets of arrow keys are used to set the number of repeats between 0 and 9999 times. Once the number of repeats has been set, press the STORE button to save the auto-sequence.



**Example:**

The following screen shot shows the number of repetitions has been set to 2023.

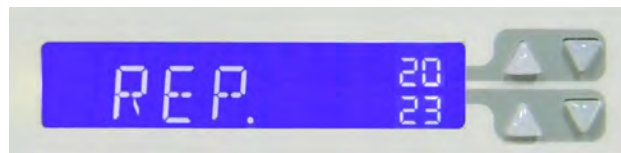

The above Auto-Sequence Edit procedure is illustrated in the flow chart shown below.

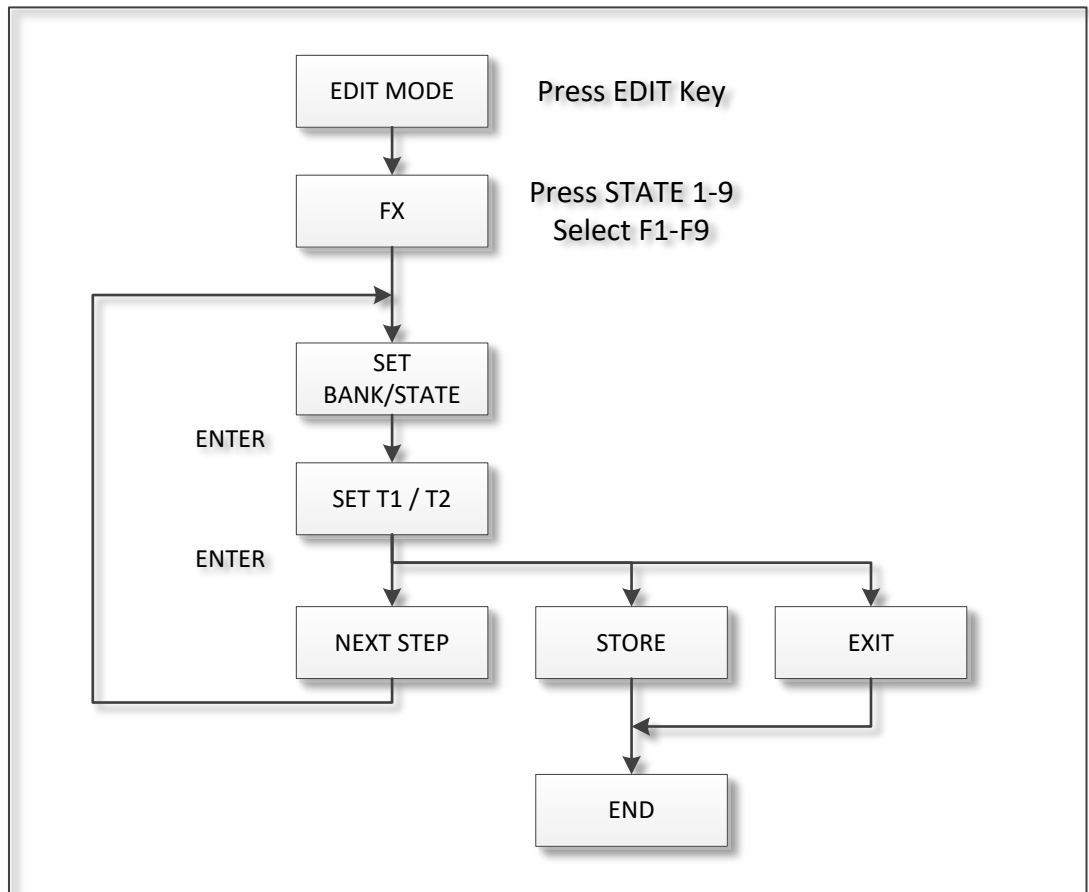
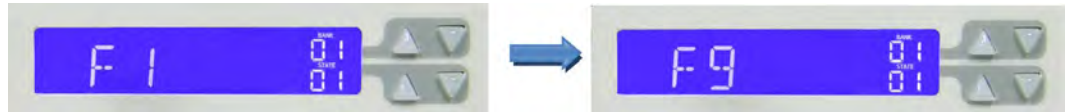

*Figure 6-3 Auto Sequence Edit Mode Procedure Flow Chart*

### 6.9.2 AUTO-SEQUENCE – TEST MODE

To execute an existing auto-sequence, proceed as follows:

1. Pressing the TEST button will cause the TEST switch to illuminate and the LCD to show the last selected Auto-sequence number (F1 to F9). The numbered STATE buttons (1-9) are used to change the Auto-sequence number (F1 ~ F9). Once the desired auto-sequence has been selected press ENTER to start the test.



2. The LCD will display "SXX", where "XX" is the actual STEP being presently tested. If during a given test step the values measured are outside the preset limits (and the NG Function has been enabled) then the LCD will flash "NG" and the test is suspended.
3. The user can press the ENTER button to continue the remaining test steps. Alternatively, the EXIT button may be used to leave the test mode.
4. If all the test steps are OK, the LCD displays "PASS". If the unit under test fails any of the test steps the mainframe's LCD will show "FAIL".
5. If the buzzer is set to ON, the PASS result is also accompanied by a single buzzer call out. If the test shows FAIL the buzzer will sound twice.
6. When the test is completed, the user can press the ENTER key again to start the test again. Alternatively, the EXIT button may be used to leave the test mode.

#### Example 1:

Once editing of the 16-step test is completed, press the TEST key. The unit will then automatically run through the test steps S01 to S16 in order. If all tests steps have been completed then the LCD will show PASS.

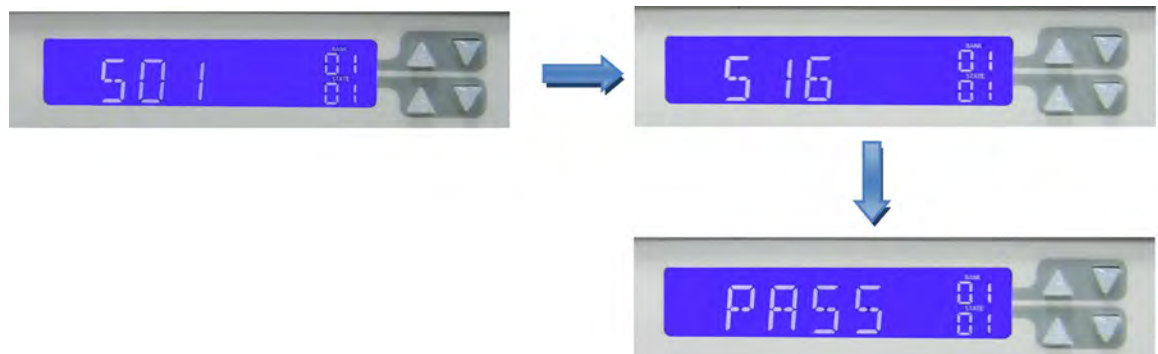

**Example 2:**

Once the edit mode has been used to set the 16-step auto-sequence, the user can press the TEST key. If the test fails at one of the test steps the LCD will flash “NG” and the test will stop. The user can then press ENTER key to continue the test or press the EXIT button to leave the test mode.

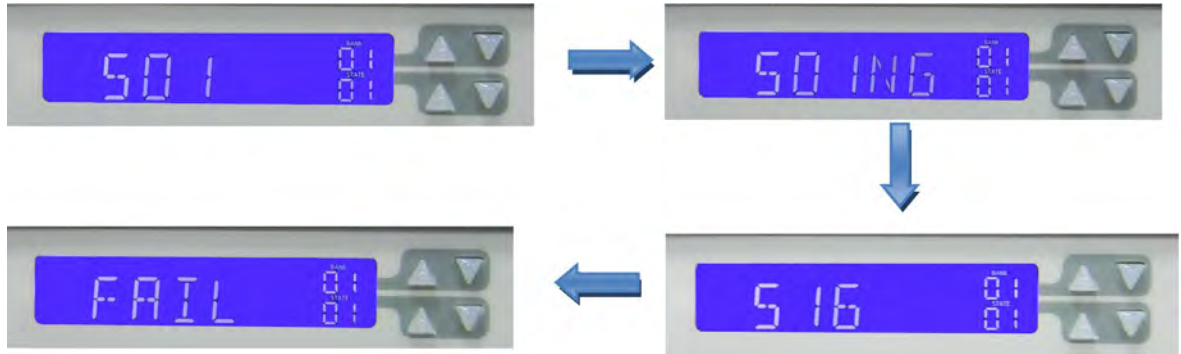

The Auto-sequence Test Process is illustrated in the flow chart shown below.

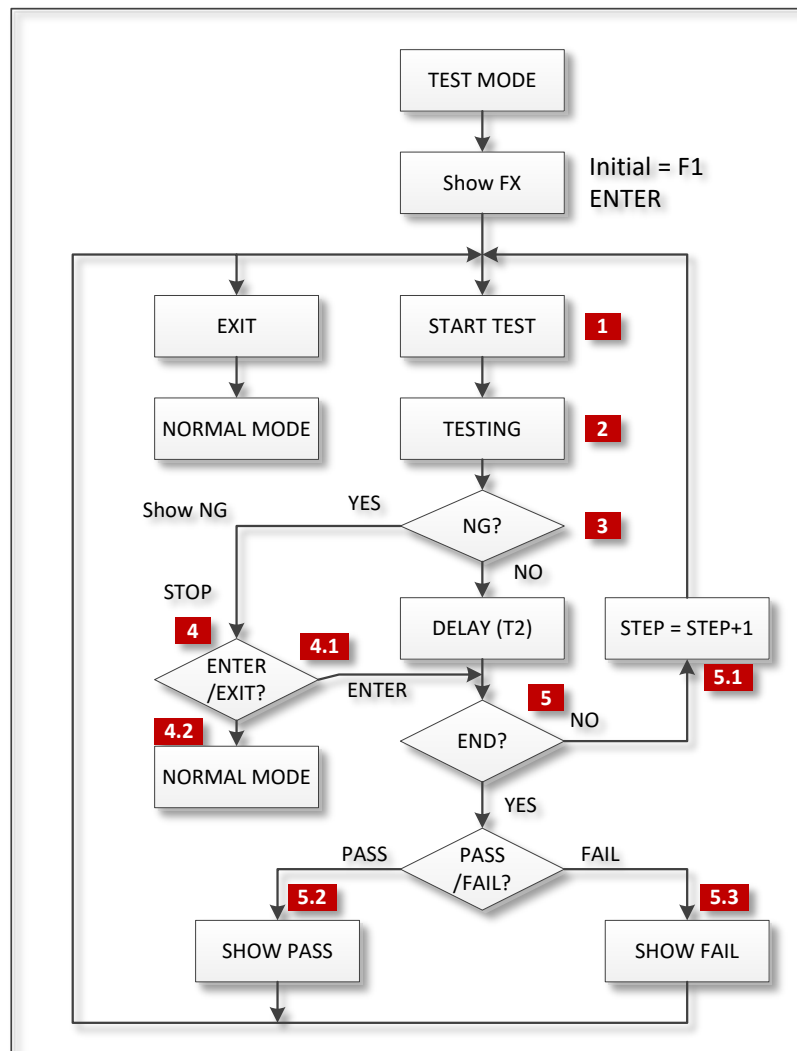

### Process Steps:

1. Recall selected setup from F1-F9 memory
2. Check results against GO/NG criteria
3. Suspend testing if results is NG
4. Wait for operator Input
  - a. If the operator pressed ENTER, continue test sequence
  - b. If the operator pressed EXIT, abort test sequence and return to Normal Mode
5. If test is GO, is this the last step in the sequence?
  - a. If no, then increment to next step and continue
  - b. If yes, then if all test steps passed, show PASS
  - c. If yes but at least one test step failed, show FAIL

## 6.10 Initial Power-on Settings

When power up the 5P Series electronic loads, the initial load settings after power ON are as shown in the tables below respectively by model number. These are the factory default settings.

### 6.10.1 Model 5P024-24 Power-on Settings

Item		Initial value	Item		Initial value
CC L+Preset		0.000 A	LIMIT	V_Hi	60.000 V
CC H+Preset		0.000 A		V_Lo	0.000 V
CR H+Preset		15000 Ω		I_Hi	240.00 A
CR L+Preset		15000 Ω		I_Lo	0.00 A
CV H+Preset		60.000 V		W_Hi	2400.0 W
CV L+Preset		60.000 V		W_Lo	0.00 W
CP L+Preset		0.000 W	CONFIG	SENSE	Auto
CP H+Preset		0.000 W		LD-ON	1.0 V
DYN	T HI	0.050 ms		LD-OFF	0.500 V
	T LO	0.050 ms		POLAR	+LOAD
	RISE	0.016 A/μs	SHORT	Disabled	
	FALL	0.016 A/μs	OPP	Disabled	
			OCP	Disabled	

Table 6-4: Model 5P024-24 Power-on Settings

### 6.10.2 Model 5P024-48 Initial Settings

Item		Initial value	Item		Initial value
CC L+Preset		0.000 A	LIMIT	V_Hi	60.000 V
CC H+Preset		0.000 A		V_Lo	0.000 V
CR H+Preset		7500 Ω		I_Hi	480.00 A
CR L+Preset		7500 Ω		I_Lo	0.00 A
CV H+Preset		60.000 V		W_Hi	2400.0 W
CV L+Preset		60.000 V		W_Lo	0.00 W
CP L+Preset		0.000 W	CONFIG	SENSE	Auto
CP H+Preset		0.000 W		LD-ON	1.0 V
DYN	T HI	0.050 ms		LD-OFF	0.500 V
	T LO	0.050 ms		POLAR	+LOAD
	RISE	0.032 A/μs	SHORT	Disabled	
	FALL	0.032 A/μs	OPP	Disabled	
			OCP	Disabled	

Table 6-5: Model 5P024-48 Power-on Settings

### 6.10.3 Model 5P036-24 Power-on Settings

Item	Initial value	Item	Initial value		
CC L+Preset	0.000 A	LIMIT	V_Hi	60.000 V	
CC H+Preset	0.000 A		V_Lo	0.000 V	
CR H+Preset	15000 Ω		I_Hi	240.00 A	
CR L+Preset	15000 Ω		I_Lo	0.00 A	
CV H+Preset	60.000 V		W_Hi	3600.0 W	
CV L+Preset	60.000 V		W_Lo	0.00 W	
CP L+Preset	0.000 W	CONFIG	SENSE	Auto	
CP H+Preset	0.000 W		LD-ON	1.0 V	
DYN	T HI		0.050 ms	LD-OFF	0.500 V
	T LO		0.050 ms	POLAR	+LOAD
	RISE		0.016 A/μs	SHORT	Disabled
	FALL		0.016 A/μs	OPP	Disabled
		OCP	Disabled		

Table 6-6: Model 5P036-24 Power-on Settings

### 6.10.4 Model 5P036-48 Initial Settings

Item	Initial value	Item	Initial value		
CC L+Preset	0.000 A	LIMIT	V_Hi	60.000 V	
CC H+Preset	0.000 A		V_Lo	0.000 V	
CR H+Preset	7500 Ω		I_Hi	480.00 A	
CR L+Preset	7500 Ω		I_Lo	0.00 A	
CV H+Preset	60.000 V		W_Hi	3600.0 W	
CV L+Preset	60.000 V		W_Lo	0.00 W	
CP L+Preset	0.000 W	CONFIG	SENSE	Auto	
CP H+Preset	0.000 W		LD-ON	1.0 V	
DYN	T HI		0.050 ms	LD-OFF	0.500 V
	T LO		0.050 ms	POLAR	+LOAD
	RISE		0.032 A/μs	SHORT	Disabled
	FALL		0.032 A/μs	OPP	Disabled
		OCP	Disabled		

Table 6-7: Model 5P036-48 Power-on Settings



### 6.10.5 Model 5P036-72 Power-on Settings

Item	Initial value	Item	Initial value		
CC L+Preset	0.000 A	LIMIT	V_Hi	60.000 V	
CC H+Preset	0.000 A		V_Lo	0.000 V	
CR H+Preset	5000 Ω		I_Hi	720.00 A	
CR L+Preset	5000 Ω		I_Lo	0.00 A	
CV H+Preset	60.000 V		W_Hi	3600.0 W	
CV L+Preset	60.000 V		W_Lo	0.00 W	
CP L+Preset	0.000 W	CONFIG	SENSE	Auto	
CP H+Preset	0.000 W		LD-ON	1.0 V	
DYN	T HI		0.050 ms	LD-OFF	0.500 V
	T LO		0.050 ms	POLAR	+LOAD
	RISE		0.048 A/μs	SHORT	Disabled
	FALL		0.048 A/μs	OPP	Disabled
		OCP	Disabled		

Table 6-8: Model 5P036-72 Power-on Settings

### 6.10.6 Model 5P054-36 Initial Settings

Item	Initial value	Item	Initial value		
CC L+Preset	0.000 A	LIMIT	V_Hi	60.000 V	
CC H+Preset	0.000 A		V_Lo	0.000 V	
CR H+Preset	10020 Ω		I_Hi	360.00 A	
CR L+Preset	10020 Ω		I_Lo	0.00 A	
CV H+Preset	60.000 V		W_Hi	5400.0 W	
CV L+Preset	60.000 V		W_Lo	0.00 W	
CP L+Preset	0.000 W	CONFIG	SENSE	Auto	
CP H+Preset	0.000 W		LD-ON	1.0 V	
DYN	T HI		0.050 ms	LD-OFF	0.500 V
	T LO		0.050 ms	POLAR	+LOAD
	RISE		0.024 A/μs	SHORT	Disabled
	FALL		0.024 A/μs	OPP	Disabled
		OCP	Disabled		

Table 6-9: Model 5P054-36 Power-on Settings

### 6.10.7 Model 5P054-72 Power-on Settings

Item	Initial value	Item	Initial value		
CC L+Preset	0.000 A	LIMIT	V_Hi	60.000 V	
CC H+Preset	0.000 A		V_Lo	0.000 V	
CR H+Preset	5000 Ω		I_Hi	720.00 A	
CR L+Preset	5000 Ω		I_Lo	0.00 A	
CV H+Preset	60.000 V		W_Hi	5400.0 W	
CV L+Preset	60.000 V		W_Lo	0.00 W	
CP L+Preset	0.000 W	CONFIG	SENSE	Auto	
CP H+Preset	0.000 W		LD-ON	1.0 V	
DYN	T HI		0.050 ms	LD-OFF	0.500 V
	T LO		0.050 ms	POLAR	+LOAD
	RISE		0.048 A/μs	SHORT	Disabled
	FALL		0.048 A/μs	OPP	Disabled
		OCP	Disabled		

Table 6-10: Model 5P054-72 Power-on Settings

### 6.10.8 Model 5P054-99 Initial Settings

Item	Initial value	Item	Initial value		
CC L+Preset	0.000 A	LIMIT	V_Hi	60.000 V	
CC H+Preset	0.000 A		V_Lo	0.000 V	
CR H+Preset	3600 Ω		I_Hi	1000.00 A	
CR L+Preset	3600 Ω		I_Lo	0.00 A	
CV H+Preset	60.000 V		W_Hi	5400.0 W	
CV L+Preset	60.000 V		W_Lo	0.00 W	
CP L+Preset	0.000 W	CONFIG	SENSE	Auto	
CP H+Preset	0.000 W		LD-ON	1.0 V	
DYN	T HI		0.050 ms	LD-OFF	0.500 V
	T LO		0.050 ms	POLAR	+LOAD
	RISE		0.066 A/μs	SHORT	Disabled
	FALL		0.066 A/μs	OPP	Disabled
		OCP	Disabled		

Table 6-11: Model 5P054-99 Power-on Settings

### 6.10.9 Model 5P072-48 Power-on Settings

Item	Initial value	Item	Initial value		
CC L+Preset	0.000 A	LIMIT	V_Hi	60.000 V	
CC H+Preset	0.000 A		V_Lo	0.000 V	
CR H+Preset	7500 Ω		I_Hi	480.00 A	
CR L+Preset	7500 Ω		I_Lo	0.00 A	
CV H+Preset	60.000 V		W_Hi	7200.0 W	
CV L+Preset	60.000 V		W_Lo	0.00 W	
CP L+Preset	0.000 W	CONFIG	SENSE	Auto	
CP H+Preset	0.000 W		LD-ON	1.0 V	
DYN	T HI		0.050 ms	LD-OFF	0.500 V
	T LO		0.050 ms	POLAR	+LOAD
	RISE		0.032 A/μs	SHORT	Disabled
	FALL		0.032 A/μs	OPP	Disabled
		OCP	Disabled		

Table 6-12: Model 5P024-24 Power-on Settings

### 6.10.10 Model 5P072-96 Initial Settings

Item	Initial value	Item	Initial value		
CC L+Preset	0.000 A	LIMIT	V_Hi	60.000 V	
CC H+Preset	0.000 A		V_Lo	0.000 V	
CR H+Preset	3750 Ω		I_Hi	960.00 A	
CR L+Preset	3750 Ω		I_Lo	0.00 A	
CV H+Preset	60.000 V		W_Hi	7200.0 W	
CV L+Preset	60.000 V		W_Lo	0.00 W	
CP L+Preset	0.000 W	CONFIG	SENSE	Auto	
CP H+Preset	0.000 W		LD-ON	1.0 V	
DYN	T HI		0.050 ms	LD-OFF	0.500 V
	T LO		0.050 ms	POLAR	+LOAD
	RISE		0.064 A/μs	SHORT	Disabled
	FALL		0.064 A/μs	OPP	Disabled
		OCP	Disabled		

Table 6-13: Model 5P024-48 Power-on Settings

### 6.10.11 Model 5P090-60 Power-on Settings

Item	Initial value	Item	Initial value		
CC L+Preset	0.000 A	LIMIT	V_Hi	60.000 V	
CC H+Preset	0.000 A		V_Lo	0.000 V	
CR H+Preset	6000 Ω		I_Hi	600.00 A	
CR L+Preset	6000 Ω		I_Lo	0.00 A	
CV H+Preset	60.000 V		W_Hi	9000.0 W	
CV L+Preset	60.000 V		W_Lo	0.00 W	
CP L+Preset	0.000 W	CONFIG	SENSE	Auto	
CP H+Preset	0.000 W		LD-ON	1.0 V	
DYN	T HI		0.050 ms	LD-OFF	0.500 V
	T LO		0.050 ms	POLAR	+LOAD
	RISE		0.040 A/μs	SHORT	Disabled
	FALL		0.040 A/μs	OPP	Disabled
		OCP	Disabled		

Table 6-14: Model 5P090-60 Power-on Settings

### 6.10.12 Model 5P108-72 Initial Settings

Item	Initial value	Item	Initial value		
CC L+Preset	0.000 A	LIMIT	V_Hi	60.000 V	
CC H+Preset	0.000 A		V_Lo	0.000 V	
CR H+Preset	5000 Ω		I_Hi	720.00 A	
CR L+Preset	5000 Ω		I_Lo	0.00 A	
CV H+Preset	60.000 V		W_Hi	10800.0 W	
CV L+Preset	60.000 V		W_Lo	0.00 W	
CP L+Preset	0.000 W	CONFIG	SENSE	Auto	
CP H+Preset	0.000 W		LD-ON	1.0 V	
DYN	T HI		0.050 ms	LD-OFF	0.500 V
	T LO		0.050 ms	POLAR	+LOAD
	RISE		0.048 A/μs	SHORT	Disabled
	FALL		0.048 A/μs	OPP	Disabled
		OCP	Disabled		

Table 6-15: Model 5P108-72 Power-on Settings

### 6.10.13 Model 5P126-84 Power-on Settings

Item	Initial value	Item	Initial value		
CC L+Preset	0.000 A	LIMIT	V_Hi	60.000 V	
CC H+Preset	0.000 A		V_Lo	0.000 V	
CR H+Preset	4284 Ω		I_Hi	840.00 A	
CR L+Preset	4284 Ω		I_Lo	0.00 A	
CV H+Preset	60.000 V		W_Hi	12600.0 W	
CV L+Preset	60.000 V		W_Lo	0.00 W	
CP L+Preset	0.000 W	CONFIG	SENSE	Auto	
CP H+Preset	0.000 W		LD-ON	1.0 V	
DYN	T HI		0.050 ms	LD-OFF	0.500 V
	T LO		0.050 ms	POLAR	+LOAD
	RISE		0.056 A/μs	SHORT	Disabled
	FALL		0.056 A/μs	OPP	Disabled
		OCP	Disabled		

Table 6-16: Model 5P126-84 Power-on Settings

### 6.10.14 Model 5P144-96 Initial Settings

Item	Initial value	Item	Initial value		
CC L+Preset	0.000 A	LIMIT	V_Hi	60.000 V	
CC H+Preset	0.000 A		V_Lo	0.000 V	
CR H+Preset	3750 Ω		I_Hi	960.00 A	
CR L+Preset	3750 Ω		I_Lo	0.00 A	
CV H+Preset	60.000 V		W_Hi	14400.0 W	
CV L+Preset	60.000 V		W_Lo	0.00 W	
CP L+Preset	0.000 W	CONFIG	SENSE	Auto	
CP H+Preset	0.000 W		LD-ON	1.0 V	
DYN	T HI		0.050 ms	LD-OFF	0.500 V
	T LO		0.050 ms	POLAR	+LOAD
	RISE		0.064 A/μs	SHORT	Disabled
	FALL		0.064 A/μs	OPP	Disabled
		OCP	Disabled		

Table 6-17: Model 5P144-96 Power-on Settings

## 7 Rear Panel Overview, Connectors and Protection Features

This section describes the rear panel layout of the 5P Series DC Loads.

### 7.1 DC INPUT Terminals

The positive and negative terminals for load input connection are located in the upper left hand corner of the rear panel when facing the back of the chassis.

**Note:** Always refer to Section 2.3 “Safety Information” and Section 2.4 “Safety Notices” before making any load connections.

#### 7.1.1 Wire Size

A major consideration in making input connection is the wire size. The minimum wire size is required to prevent overheating and to maintain good regulation. It is recommended that the wires are sized large enough to limit the voltage drop at the maximum current rating of the DC load to less than 0.5V per lead.

#### 7.1.2 Connecting a UUT

 WARNING

### DO NOT EXCEED LOAD INPUT VOLTAGE RATING

**This instrument does NOT have a means to disconnect its Load input from a connected power supply. If the voltage applied to the Load input exceeds its maximum rating – even if the load is turned completely off – damage to the load WILL occur. Damage caused by exceeded maximum load input voltage under any circumstance is NOT covered by the manufacturer’s product warranty. Remove any load input connections when the load is not in use, even when it is turned off.**

When setting up for a new test and connecting any equipment to the DC load, proceed as follows:

1. Always make sure the DC load is turned OFF at the POWER switch when making any wire connections.
2. Check that the output of the equipment under test is **OFF**.  
**Note:** Some power equipment’s output may still be energized even if the equipment has been turned off or its output is turned off. This is especially true for DC power supplies.

Note: When working with batteries, it is recommended to provide a suitable disconnect relay or switch so the load connection can be disconnected from the battery for handling purposes.

3. Connect one end of the load wires to the load input terminals on the rear panel.
4. Check the polarity of the connections and connect the other end of the load wires to the output terminal of the equipment under test.
5. When connecting multiple loads to the same EUT, make sure the load wire lengths to each load are the same.

### 7.1.3 Polarity and Ground

- It is recommended to connect the negative DC terminal to ground for positive output power supply EUTs.
- It is recommended to connect the positive DC terminal to ground for negative output power supply EUTs.

## 7.2 Voltage Sense Input Terminals

To measure the UUT output DC voltage at the UUT terminals, external voltage sense mode must be used. The external voltage sense terminal is provided for this purpose. Refer to the illustration below for details on the V Sense terminal location and polarity.

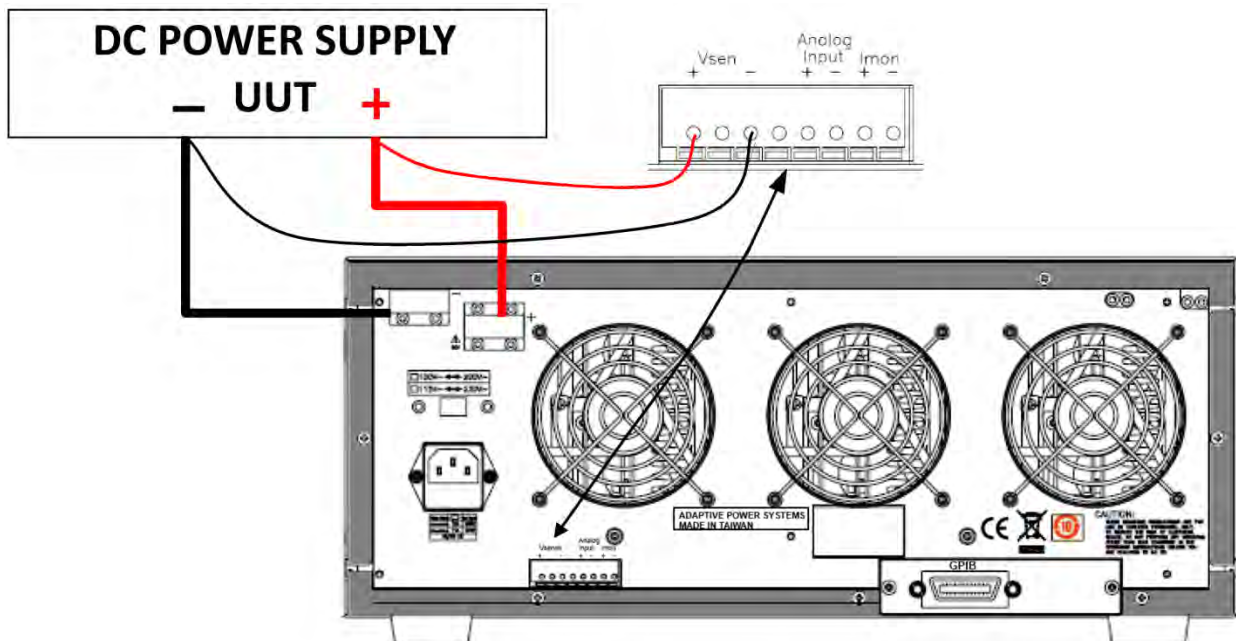

Figure 7-1: DC Load Connection with External Voltage Sense

### 7.3 Current Output Monitor (I-Monitor)

The I-Monitor terminal is designed to monitor the electronic load's input current or short current. An isolated amplifier output with 0V to 10V full scale output signal represents the zero to full scale current the electronic load is sinking.

Please refer to the I-Monitor voltage /current scaling values for each 5P Series load model in Section 4, "Technical Specifications".

#### 7.3.1 Non-Isolated Output

The I-Monitor output can be used to display and capture the load current waveform on a digital storage oscilloscope to further evaluate the voltage and current waveform of a power supply under test.

**Note:** The I-Monitor is non-isolated. It is intended to support power supply development and testing and must be ground referenced.

To allow monitoring of both voltage and current simultaneously on a dual channel oscilloscope, care must be taken not to create ground loops. Most oscilloscope inputs are ground referenced and input channels are **not** isolated from each other.

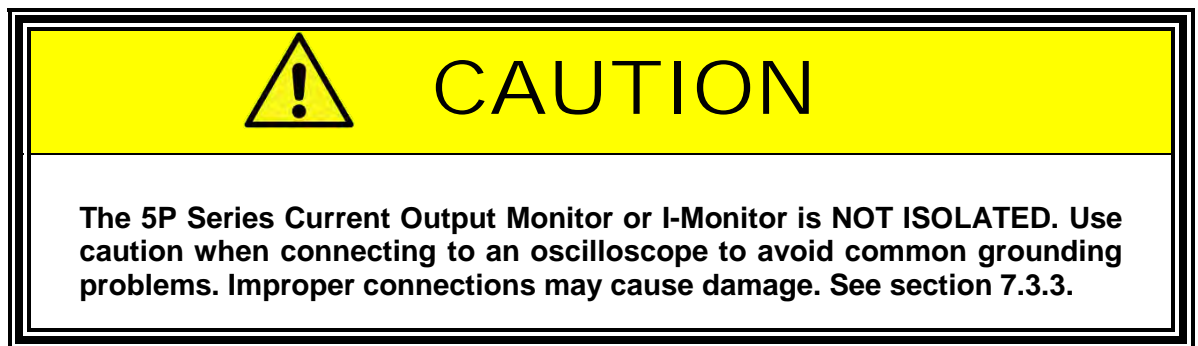



### 7.3.2 Output Impedance

The I-Monitor output volt range is 0 to 10V. Output impedance is 1K $\Omega$ . The equivalent output circuit of the I-Monitor output is shown in the figure below.

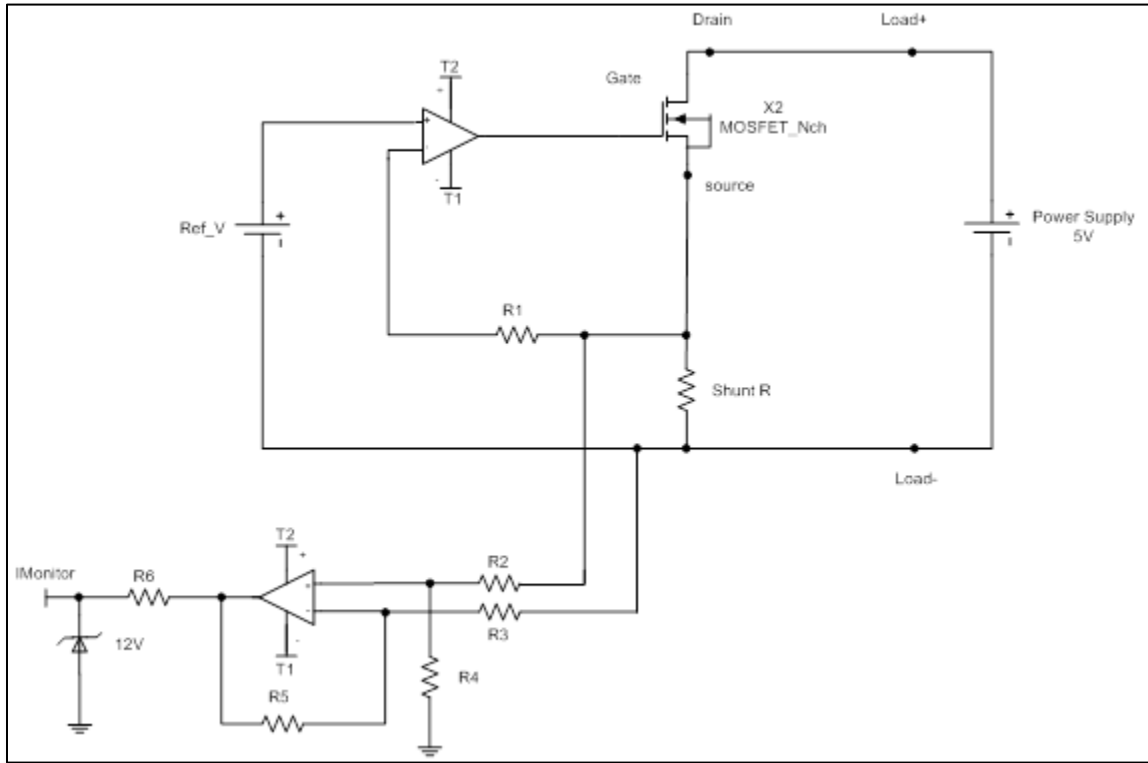

Figure 7-2: Equivalent I-Monitor Output Circuit

### 7.3.3 Connecting I-Monitor Output to an Oscilloscope

When you connect the load's current monitor to an oscilloscope, please carefully check the polarities of the scope probes of the oscilloscope as shown in Figure 7-3.

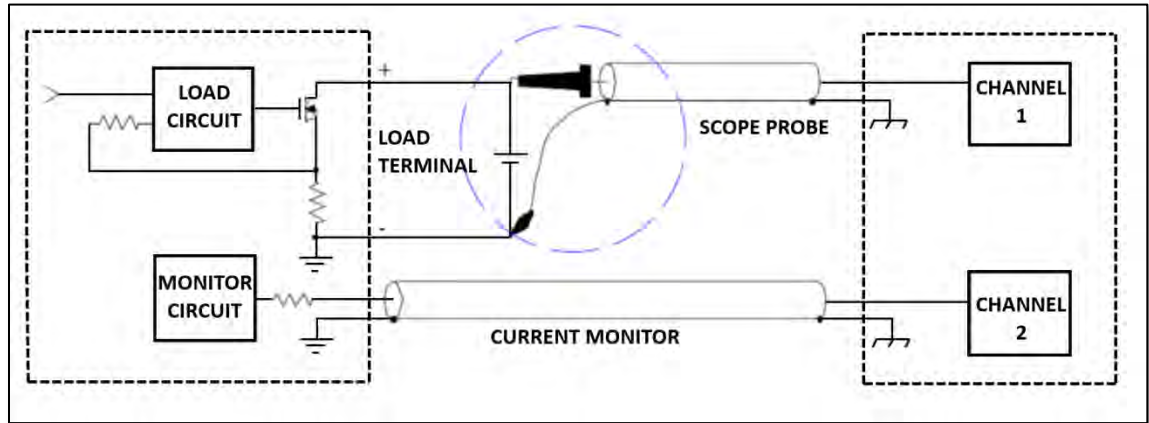

Figure 7-3: Correct I-Monitor Connections to UUT and Oscilloscope

Reversing signal and ground on the voltage probe will result in a current to flow to ground as shown in Figure 7-4 and may damage the UUT, the oscilloscope and possibly the electronic load.

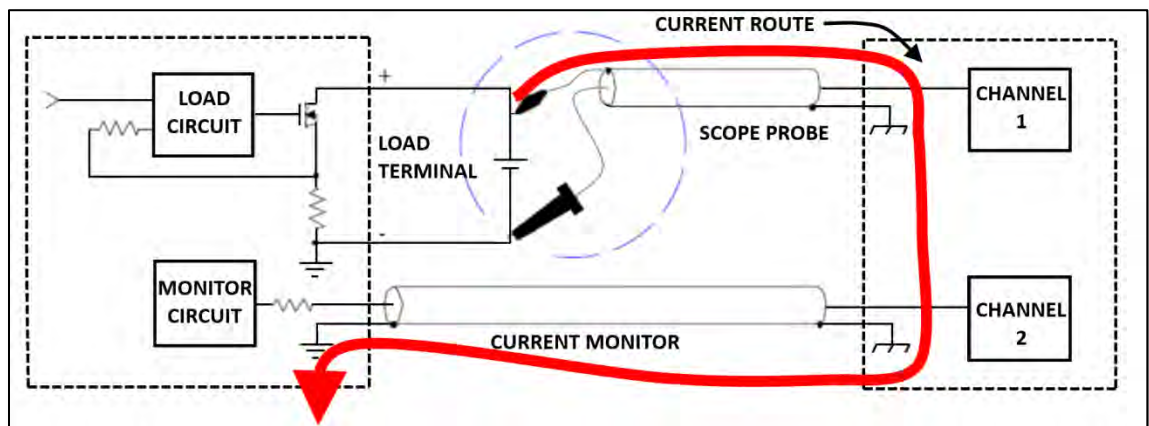

Figure 7-4: *Incorrect* I-Monitor Connections to UUT and Oscilloscope

## 7.4 Parallel Operation

It is possible to operate two or more loads in parallel if the power and/or current capability of a single load is not sufficient.

### 7.4.1 Parallel Mode Connection

The positive and negative outputs of the power supply must be connected individually to each load's input as shown in Figure 7-5 below. The setting is made at each individual load module. The total load current is the sum of the load currents being taken by each module.

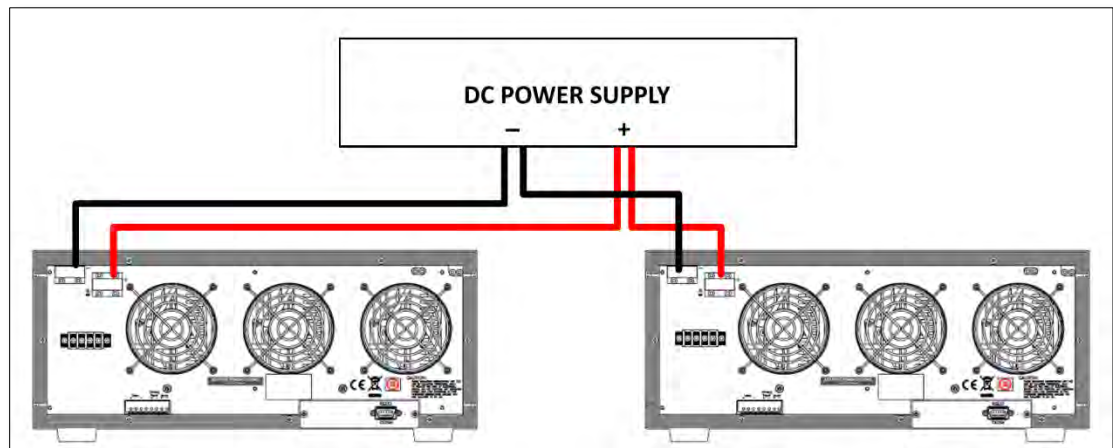

Figure 7-5: Parallel Load Connection

### 7.4.2 Allowable Operating Modes

It is permitted to operate loads modules with different voltage, current and power ratings to sink in parallel. For example the loads shown in Figure 7-5 could be a mixture of 5P024-48 and 5P036-24.

While in static mode, the load modules can be set to operate in CC, CR or CP mode.

### 7.4.3 Exceptions

1. Parallel operation in DYNAMIC mode is not allowed.
2. Parallel operation in CV mode is not possible.



## 7.5 Series Operation

Series operation of DC loads to achieve higher voltage ranges than supported by an individual load is **NOT** allowed under any circumstance.



## 7.6 Zero-Voltage Loading

As shown in Figure 7-6, the Electronic load can be connected in series with a DC voltage source (DC power supply in CV mode) with an output voltage greater than 0.7Vdc.

This allows the device under test connected to the electronic load to be operated down to a zero volt condition. The external DC voltage source provides the minimum operating voltage required by the electronic load. This application is suitable for low voltage battery cell, high discharge current testing.

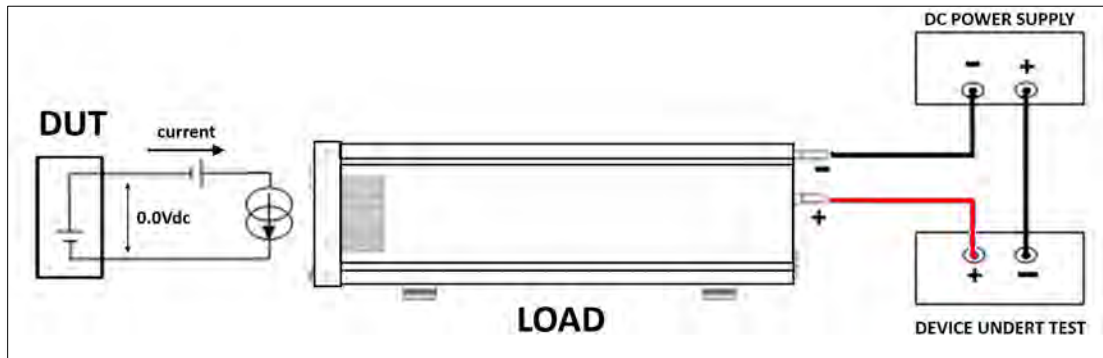

Figure 7-6: Zero Volt Load Connection

## 7.7 Protection Features

The 5P Series electronic loads include the following protection features:

- Over Voltage
- Over Current
- Over Power
- Over Temperature
- Reverse Polarity Indication

### 7.7.1 Over Voltage Protection

The over voltage protection circuit is set at a predetermined voltage (63V for the 5P Series), which **cannot** be changed. If the over voltage circuit has tripped, the load input turns OFF immediately to prevent damaging the load. When an over voltage trip condition has occurred, the digital current meter's LCD display will indicate "OVP".

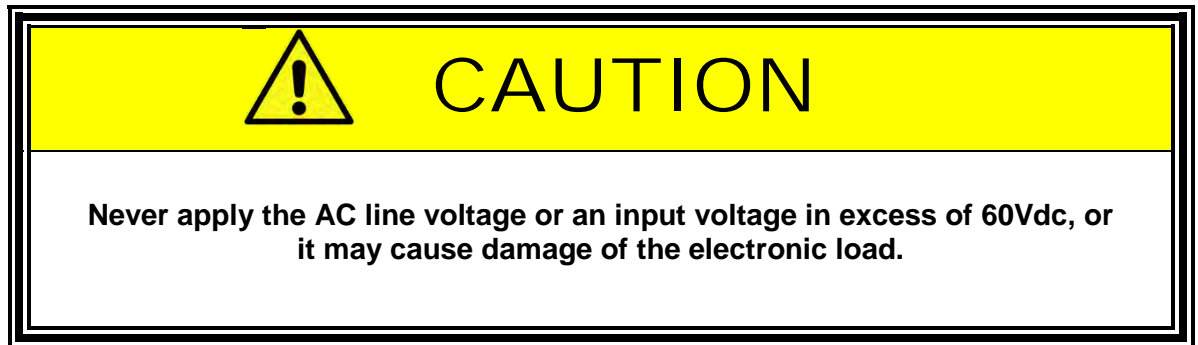

### 7.7.2 Over Current Protection

The load always monitors the current it is sinking. When the current sink is greater than 105% of the rated maximum current, the load module will turn load to OFF state internally. When an over current condition has occurred, the digital current meter's LCD display will indicate "OCP".

### 7.7.3 Over Power Protection

The load always monitors the power dissipated by the load. When the power dissipation is greater than 105% of the rated power input, the load module will turn load to OFF state internally. When an over power condition has occurred, the digital current meter's LCD display will indicate "OPP".

#### 7.7.4 Over Temperature Protection

As soon as the temperature of load's internal heat sinks reaches a level greater than 85° C (180° F), the over temperature protection is triggered. The digital current meter's LCD display will indicate "OTP". The Load will turn to the OFF state internally.

Please check environmental conditions such as the ambient temperature and distance between the rear panel of the load chassis and any wall is greater than 15cm / 6 inches.

The load can reset the Over Voltage, Over Current, Over Power and Over Temperature protection if the condition that caused the fault is removed and the "LOAD" key is pressed to set "ON" state.

#### 7.7.5 Reverse Polarity Protection Indication

The 5P Series electronic load conducts reverse current when the polarity of the DC source connection is incorrect. The maximum reverse current is 120A for all 5P Series models. If the reverse current exceeds the maximum reverse current, it may damage the load.

When a reverse polarity current condition exists, the reverse current is displayed on the 5 digit current meter on the front panel, and the 5-digit DCM indicates a **negative** current reading. Whenever a reverse current is displayed on the current meter, turn OFF power to the DC source immediately and make the correct connections.

## 8 Remote Control Programming

### 8.1 Overview

If your unit is fitted with a computer interface option then a GPIB, RS232, USB or LAN connector will be present on the rear panel based on the order configuration. The interface allows the load settings to be configured remotely and measurement data to be retrieved for analysis and test report generation.

There are two sets of programming commands for APS Loads. One is referred to as the SHORT FORM commands and the other set as the LONG FORM commands.

For Example

To query the actual voltage present at the load from the load's measurement system, the long form command is:

*MEASURE:VOLTAGE?*

The same command in its short form is:

*MEAS:VOLT?*

**NOTE:** When either one of the RS232, USB or LAN interface options is used to control the load, it is important to send the "REMOTE" command first to make sure the load is in REMOTE state. To return the load to local operation, the "LOCAL" command is used. These two commands do not apply to the GPIB interface as remote and local state of an instruments is handled through the GPIB ATN hardware signal per the IEEE488 standard.

## 8.2 RS232 Set-up

The RS232 interface of the APS load is configured as follows:

Baud-rate: 9600 - 115200bps (selectable using the SYSTEM key)  
 Parity: None  
 Data bit: 8 bits  
 Stop bit: 1 bit  
 Handshaking: Hardware (RTS/CTS).

Make sure the settings used on the controller's COM port match those of the load.

The RS232 Interface connector DB9 pin-out of the load is shown in Table 8-1.

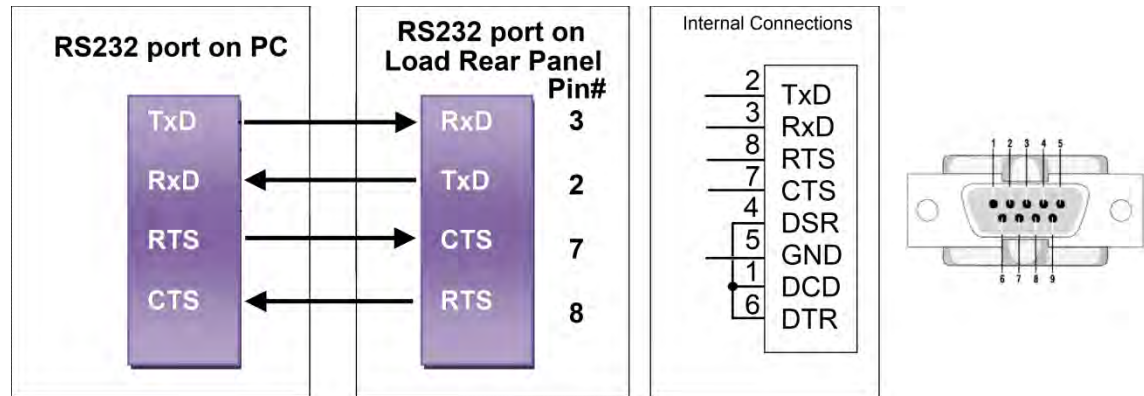

Figure 8-1: RS232 Connection to PC and DB9 Pin out

Signal Pin Assignments:

PIN	Abbreviation	Description
Pin1	DCD	Direct Carrier Detect
Pin2	TXD	Transmit Data
Pin3	RXD	Receive Data
Pin4	DTR	Data Terminal Ready
Pin5	GND	Ground
Pin6	DSR	Data Set Ready
Pin7	RTS	Request To Send
Pin8	CTS	Clear To Send
Pin9	RI	Ring Indicator

Table 8-1: RS232 DB9 Pin Assignments



## 8.3 Programming Syntax

A variety of syntax notations are used in the description of the remote control commands and in the summary tables. The syntax used is defined as follows:

- SP Space, the ASCII code is 20 hexadecimal.
- ; Semicolon, program line terminator, the ASCII code is 0A hexadecimal.
- NL New line, program line terminator, the ASCII code is 0A hexadecimal.
- NR2 Numeric value with decimal point. Values can be accepted in the range and format of ###.#####. For example: 30.12345. In this instance, the load will read up to five significant digits after the decimal point. The decimal point can be omitted if not required.

### 8.3.1 Parenthesis

The following parentheses are used in the command descriptions to indicate whether a command is necessary or optional and whether a choice has to be made. The symbols { }, [ ], | are not actually used in the programming commands. The symbols { }, [ ] and | are merely used to illustrate the command syntax.

- |                      |   |
|----------------------|---|
| { } - Required:      | The contents of the { } symbol must be used as part of the command, it cannot be omitted.   |
| [ ] - Optional:      | The contents of the [ ] symbol indicates that the command is optional. The use of the contents depends on the test application.   |
| - Required Choice:   | This symbol means a choice must be made between the stated command key words. For example, "LOW HIGH" Means a LOW or HIGH choice needs to be made as part of the command. |
| ? - Required Choice: | The question mark implies the query format of the command.  |

### 8.3.2 Terminators

All remote control commands sent to the load must be terminated with a command terminator. The command terminator characters accepted by the APS loads are listed in Table 8-2.

Terminator	Hex Code	Decimal	C Code	Notes
<b>LF</b>	0x0A	10	\n	
<b>LF+EOI</b>	0x0A	10	\n	GPIB only
<b>CR+LF</b>	0x0D + 0x0A	13 + 10	\r\n	
<b>CR+LF+EOI</b>	0x0D + 0x0A	13 + 10	\r\n	GPIB only

*Table 8-2: Supported Command Terminators*

Semicolon “;” The semicolon character allows you to combine multiple commands in one message string to create a command sequence. The commands will be parsed in the order in which they are received.

## 8.4 Short Form Command Syntax

The setting and query commands for the 5P Series are listed in the summary tables below. Short form commands use an abbreviated syntax, which reduces the amount of characters required for each command and thus increases throughput.

SETTING PRESET NUMERIC COMMAND SUMMARY	REMARK
RISE{SP} {NR2} { ;   NL }	(m)A/us
FALL{SP} {NR2} { ;   NL }	(m)A/us
PERD : {HIGH   LOW} {SP} {NR2} { ;   NL }	
LDONV{SP} {NR2} { ;   NL }	
LDOFFV{SP} {NR2} { ;   NL }	
CC  CURR : {HIGH   LOW} {SP} {NR2} { ;   NL }	
CP:{HIGH   LOW} {SP} {NR2} { ;   NL }	
CR  RES : {HIGH   LOW} {SP} {NR2} { ;   NL }	
CV  VOLT : {HIGH   LOW} {SP} {NR2} { ;   NL }	
TCONFIG {SP} {NORMAL   OCP   OPP   SHORT} { ;   NL }	
OCP:START {SP} {NR2} { ;   NL }	
OCP:STEP {SP} {NR2} { ;   NL }	
OCP:STOP {SP} {NR2} { ;   NL }	
VTH {SP} {NR2} { ;   NL }	
OPP:START {SP} {NR2} { ;   NL }	
OPP:STEP {SP} {NR2} { ;   NL }	
OPP:STOP {SP} {NR2} { ;   NL }	
STIME {SP} {NR2} { ;   NL }	

Table 8-3: Setting Commands - Short Form

QUERY PRESET NUMERIC COMMAND SUMMARY	RETURN FORMAT
RISE {?} { ;   NL}	###.####
FALL {?}{ ;   NL}	###.####
PERD : {HIGH   LOW}{?} { ;   NL}	###.####
LDONV {?}{ ;   NL}	###.####
LDOFFV {?}{ ;   NL}	###.####
CC   CURR : {HIGH   LOW} {?} { ;   NL}	###.####
CP: {HIGH   LOW} {?} { ;   NL}	###.####
CR   RES : {HIGH   LOW} {?} { ;   NL}	###.####
CV   VOLT : {HIGH   LOW} {?} { ;   NL}	###.####
RISE {?} { ;   NL}	###.####
FALL {?}{ ;   NL}	###.####
PERD : {HIGH   LOW}{?} { ;   NL}	###.####
TCONFIG {?}{ ;   NL}	1:NORMAL
	2:OCP
	3:OPP
	4:SHORT
OCP: START {?} { ;   NL}	###.####
OCP: STEP {?}{ ;   NL}	###.####
OCP: STOP {?}{ ;   NL}	###.####
VTH {?}{ ;   NL}	###.####
OPP: START {?} { ;   NL}	###.####
OPP: STEP {?}{ ;   NL}	###.####
OPP: STOP {?}{ ;   NL}	###.####
STIME {?}{ ;   NL}	###.####
OCP {?}{ ;   NL}	###.####
OPP {?}{ ;   NL}	###.####

Table 8-4: Query Commands - Short Form

LIMIT COMMAND SUMMARY	RETURN FORMAT
IH   IL{SP}{NR2}{ ;   NL}	
IH   IL{?}{ ;   NL}	
WH   WL{SP}{NR2}{ ;   NL}	
WH   WL{?}{ ;   NL}	###.####
VH   VL{SP}{NR2}{ ;   NL}	
VH   VL{?}{ ;   NL}	###.####
SVH   SVL{SP}{NR2}{ ;   NL}	
SVH   SVL{?}{ ;   NL}	###.####

Table 8-5: Limit Commands - Short Form

TEST COMMAND SUMMARY	REMARK
LOAD {SP}{ON OFF 1 0};   NL}	
LOAD {?} {};   NL}	0: OFF   1: ON
MODE {SP}{CC   CR   CV   CP};   NL}	
MODE {?} {};   NL}	0: CC   1: CR 2: CV   3: CP
SHOR {SP}{ON OFF 1 0};   NL}	
SHOR {?} {};   NL}	0: OFF   1: ON
PRES {SP}{ON OFF 1 0};   NL}	
PRES {?} {};   NL}	0: OFF   1: ON
SENS {SP}{ON AUTO 1 0};   NL}	
SENS {SP}{ON OFF} {};   NL}	
SENS {?} {};   NL}	0: OFF/AUTO   1: ON
LEV {SP}{LOW HIGH 0 1};   NL}	
LEV {?} {};   NL}	0: LOW   1: HIGH
DYN{SP}{ON OFF 1 0};   NL}	
DYN{?} {};   NL}	0: OFF   1: ON
CLR{};   NL}	
ERR {?}{};   NL}	
NG {?}{};   NL}	0: GO   1: NG
PROT {?}{};   NL}	
CCR{SP}{AUTO R2};   NL}	
NGENABLE{SP}{ON OFF};   NL}	
POLAR{SP}{POS NEG};   NL}	
START{};   NL}	
STOP{};   NL}	
TESTING {?} {};   NL}	0:TEST END   1:TESTING

Table 8-6: Test Commands - Short Form

SYSTEM COMMANDS	NOTES	RETURN FORMAT
RECALL {SP} {m [,n] };   NL}	m=1 -10, n=1 – 15 m:STATE, n:BANK	
STORE {SP} {m [,n] };   NL}	m=1 – 10, n=1 – 15 m:STATE , n:BANK	
REMOTE {};   NL}	RS232/USB/LAN only command	
LOCAL{};   NL}	RS232/USB/LAN only command	
NAME {?} {};   NL}		“XXXXX”

Table 8-7: System Commands - Short Form

MEASUREMENT QUERY COMMAND SUMMARY	RETURN
MEAS:CURR {?} {;}   NL}	###.####
MEAS:VOLT {?} {;}   NL}	###.####
MEAS:POW {?} {;}   NL}	###.####

Table 8-8: Measurement Query Commands - Short Form

AUTO SEQUENCE COMMANDS	NOTES	RETURN
FILE {SP} {n} {;}   NL}	n=1 - 9	1 - 9
STEP {SP} {n} {;}   NL}	n=1 - 16	1 - 16
TOTSTEP {SP} {n} {;}   NL}	Total step n=1 - 16	1 - 16
SB {SP} {m, n} {;}   NL}	m=1 - 10 n=1 - 15 m:STATE, n:BANK	
T1 {SP} {NR2} {;}   NL}	0.1 - 9.9(s)	0.1 - 9.9 (sec)
T2 {SP} {NR2} {;}   NL}	0.1 - 9.9(s)	0.1 - 9.9 (sec)
SAVE {;}   NL}	Save "File n" data	
REPEAT {SP} {n} {;}   NL}	n=0 - 9999	0 - 9999
RUN {SP} {F} {n} {;}   NL}	n=1 - 9	AUTO REPLY "PASS" or "FAIL:XX" (XX=NG STEP)

Table 8-9: Auto Sequence Commands - Short Form

#### 8.4.1 Notations and Conventions Used in programming commands:

1. Current engineering unit: A
2. Voltage engineering unit: V
3. Resistance engineering unit:  $\Omega$
4. Time Period engineering unit: ms
5. Slew-rate engineering unit: (m)A/us
6. Power engineering unit: W

## 8.5 Long Form Command Syntax

The setting and query commands for the 5P Series are listed in the summary tables below. Long form commands use extended command key words for easier code readability.

SETTING COMMAND SUMMARY	REMARK
[PRESet:] RISE{SP} {NR2} {;}   NL}	(m)A/us
[PRESet:] FALL{SP} {;}   NL}	(m)A/us
[PRESet:] PERI   PERD : HIGH   LOW {SP} {NR2} {;}   NL}	
[PRESet:] LDONv{SP} {NR2} {;}   NL}	
[PRESet:] LDOFv{SP} {NR2} {;}   NL}	
[PRESet:] CC   CURR: {HIGH   LOW} {SP} {NR2} {;}   NL}	
[PRESet:] CP: {HIGH   LOW} {SP} {NR2} {;}   NL}	
[PRESet:] CR   RES: {HIGH   LOW} {SP} {NR2} {;}   NL}	
[PRESet:] CV   VOLT: {HIGH   LOW} {SP} {NR2} {;}   NL}	
[PRESet:] FALL{SP} {;}   NL}	
[PRESet:] PERI   PERD : HIGH   LOW {SP} {NR2} {;}   NL}	
[PRESet:] CV   VOLT {SP} {NR2} {;}   NL}	
[PRESet:] TCONFIG {SP} {NORMAL   OCP   OPP   SHORT} {;}   NL}	
[PRESet:] OCP:START {SP} {NR2} {;}   NL}	
[PRESet:] OCP:STEP {SP} {NR2} {;}   NL}	
[PRESet:] OCP:STOP {SP} {NR2} {;}   NL}	
[PRESet:] VTH {SP} {NR2} {;}   NL}	
[PRESet:] OPP:START {SP} {NR2} {;}   NL}	
[PRESet:] OPP:STEP {SP} {NR2} {;}   NL}	
[PRESet:] OPP:STOP {SP} {NR2} {;}   NL}	
[PRESet:] STIME {SP} {NR2} {;}   NL}	

Table 8-10: Setting Commands - Long Form

QUERY COMMAND SUMMARY	RETURN FORMAT
[PRESet:] RISE {?} {;}   NL}	###.####
[PRESet:] FALL {?} {;}   NL}	###.####
[PRESet:] PERI   PERD: {HIGH   LOW}{?}{;}   NL}	###.####
[PRESet:] LDONv {?} {;}   NL}	###.####
[PRESet:] LDOFv {?} {;}   NL}	###.####
[PRESet:] CC   CURR: {HIGH   LOW} {?}{;}   NL}	###.####
[PRESet:] CP: {HIGH   LOW} {?}{;}   NL}	###.####
[PRESet:] CR   RES: {HIGH   LOW} {?}{;}   NL}	###.####
[PRESet:] CV   VOLT: {HIGH   LOW} {?}{;}   NL}	###.####
[PRESet:] TCONFIG {?}{;}   NL}	1:NORMAL 2:OCP 3:OPP 4:SHORT
[PRESet:] OCP: START {?}{;}   NL}	###.####
[PRESet:] OCP: STEP {?}{;}   NL}	###.####
[PRESet:] OCP: STOP {?}{;}   NL}	###.####
[PRESet:] VTH {?}{;}   NL}	###.####
[PRESet:] OPP: START {?}{;}   NL}	###.####
[PRESet:] OPP: STEP {?}{;}   NL}	###.####
[PRESet:] OPP: STOP {?}{;}   NL}	###.####
[PRESet:] STIME {?}{;}   NL}	###.####

Table 8-11: Query Commands - Long Form

LIMIT COMMAND SUMMARY	RETURN FORMAT
LIMit:CURRent: {HIGH   LOW}{SP}{NR2} {;}   NL}	
LIMit:CURRent: {HIGH   LOW}{?}{;}   NL}	###.####
IH   IL{SP}{NR2} {;}   NL}	
IH   IL{?}{;}   NL}	
LIMit:POWer: {HIGH   LOW}{SP}{NR2} {;}   NL}	
LIMit:POWer: {HIGH   LOW}{?}{;}   NL}	###.####
WH   WL{SP}{NR2} {;}   NL}	
WH   WL{?}{;}   NL}	###.####
LIMit:VOLTagE: {HIGH   LOW}{SP}{NR2} {;}   NL}	
LIMit:VOLTagE: {HIGH   LOW}{?}{;}   NL}	###.####
VH   VL{SP}{NR2} {;}   NL}	
VH   VL{?}{;}   NL}	###.####
SVH   SVL{SP}{NR2} {;}   NL}	
SVH   SVL{?}{;}   NL}	###.####

Table 8-12: Limit Commands - Long Form



STATE COMMAND SUMMARY	REMARK
[STATE:] LOAD {SP}{ON OFF} {;}   NL}	
[STATE:] LOAD {?} {;}   NL}	0: OFF   1: ON
[STATE:] MODE {SP} {CC CR CV CP} {;}   NL}	
[STATE:] MODE {?} {;}   NL}	0: CC   1: CR 2: CV   3: CP
[STATE:] SHORt {SP} {ON OFF} {;}   NL}	
[STATE:] SHORt {?} {;}   NL}	0: OFF   1: ON
[STATE:] PRESet {SP} {ON OFF} {;}   NL}	
[STATE:] PRESet {?} {;}   NL}	0: OFF   1: ON
[STATE:] SENSE {SP} {ON AUTO} {;}   NL}	
[STATE:] SENSE {SP} {ON OFF} {;}   NL}	
[STATE:] SENSE {?} {;}   NL}	0: OFF/AUTO   1: ON
[STATE:] LEVEL {SP} {LOW HIGH} {;}   NL}	
[STATE:] LEVEL {?} {;}   NL}	0: LOW   1: HIGH
[STATE:] DYNAmic {SP} {ON OFF} {;}   NL}	
[STATE:] DYNAmic {?} {;}   NL}	0: OFF   1: ON
[STATE:] CLR{;}   NL}	
[STATE:] ERROr {?} {;}   NL}	
[STATE:] NO {SP} GOOD {?} {;}   NL}	0: GO   1: NG
[STATE:] NG {?} {;}   NL}	0 : GO, 1 : NG
[STATE:] PROTEct {?} {;}   NL}	
[STATE:] CCR {SP} {AUTO R2} {;}   NL} (NOTE 1)	
[STATE:] NGENABLE{SP}{ON OFF}{;}   NL}	
[STATE:]POLAR{SP}{POS NEG}{;}   NL}	
[STATE:]START{;}   NL}	
[STATE:]STOP{;}   NL}	
[STATE:] TESTING {?} {;}   NL}	0:TEST END   1:TESTING

Table 8-13: State Commands - Long Form

SYSTEM COMMANDS	NOTE	RETURN FORMAT
[SYStem:] RECall {SP} {m [,n]} {;}   NL}	m=1 – 10, n=1 - 15	
[SYStem:] STORe {SP} {m [,n]} {;}   NL}	m=1 – 10, n=1 - 15	
[SYStem:] REMOTE {;}   NL}	RS232/USB/LAN command	
[SYStem:] LOCAL {;}   NL}	RS232/USB/LAN command	
[SYStem:] NAME {?} {;}   NL}		“XXXXX”
[SYStem:]*RST {;}   NL}		
[SYStem:]SYNC:LOAD {SP} {ON OFF} {;}   NL}		

Table 8-14: System Commands - Long Form

MEASUREMENT QUERY COMMAND SUMMARY	RETURN FORMAT
MEASure:CURRent {?} {;}   NL}	###.####
MEASure:VOLTage {?} {;}   NL}	###.####
MEASure:POWer {?} {;}   NL}	###.####

Table 8-15: Measurement Query Commands

AUTO SEQUENCE COMMANDS	NOTES	RETURNS
FILE {SP} {n} {;}   NL}	n=1 - 9	1 - 9
STEP {SP} {n} {;}   NL}	n=1 - 16	1 - 16
TOTSTEP {SP} {n} {;}   NL}	Total steps n=1 - 16	1 - 16
SB {SP} {m,n} {;}   NL}	m=1 -10, n=1 - 15 m:STATE, n:BANK	
T1 {SP} {NR2} {;}   NL}	0.1 - 9.9(s)	0.1 - 9.9 (sec)
T2 {SP} {NR2} {;}   NL}	0.1 - 9.9(s)	0.1 - 9.9 (sec)
SAVE {;}   NL}	Save "File n" data	
REPEAT {SP} {n} {;}   NL}	n=0 - 9999	0 - 9999
RUN {SP} {F} {n} {;}   NL}	n=1 - 9	AUTO REPLY "PASS" or "FAIL:XX" (XX=NG STEP)

Table 8-16: Auto Sequence Commands - Long Form

## 8.6 Remote Control Command Descriptions

The remote control syntax of all available commands is described in the following sections. Supported commands are grouped in the following categories:

Command Category	Description
<b>SETTING</b>	Setting commands are used to program operating modes, sink values and built in test modes like SHORT, OPP and OCP.
<b>LIMIT</b>	Limit commands may be used to set expected upper and lower operating limits as they apply to a unit under test. These limit settings are used in conjunction with Go/No-go testing to indicate the load is sinking outside expected parameters.
<b>STATE</b>	State commands are used to query or clear status information from a load module to determine its operating condition.
<b>SYSTEM</b>	System commands enable querying of load module model number and configuration data, RS232 control on/off. They also support storing and saving load set-ups in non-volatile memory. (15 Banks / 10 States)
<b>MEASUREMENTS</b>	Allows querying load measurement data.

### 8.6.1 SETTING Commands

#### RISE

**Command Syntax:**

[PRESet:] RISE {SP} {NR2} {; | NL}

[PRESet:] RISE ? {; | NL}

**Purpose:**

Set and read the RISE SLEW-RATE.

**Description:**

1. The definition of the RISE SLEW-RATE is the rate of current change from a LOW level to a HIGH level when operating in dynamic mode. The settings of RISE and FALL are completely independent.
2. The RISE command must include a number value otherwise, the command will not be valid.
3. The least significant number is the fourth digit after the decimal point.
4. Should a value be entered that is higher than what is possible then the load will automatically set its maximum value according the load module fitted.
5. The engineering unit is A/us.

#### FALL

**Command Syntax:**

[PRESet:] FALL {SP} {; | NL}

[PRESet:] FALL? {; | NL}

**Purpose:**

Set and read the FALL SLEW-RATE.

**Description:**

1. The definition of the FALL SLEW-RATE is the rate of current change from a HIGH level to a LOW level when operating in dynamic mode. The settings of RISE and FALL are completely independent.
2. Should a value be entered that is higher than what is possible then the load will automatically set its maximum value according the load module fitted.
3. The engineering unit is A/us.

**PERI or PERD****Command Syntax:**

```
[PRESet:] PERI | PERD : HIGH | LOW {SP} {NR2} { ; | NL}
```

```
[PRESet:] PERI | PERD : HIGH | LOW ? { ; | NL}
```

**Purpose:**

Set and read the combined TLOW and THIGH of a DYNAMIC waveform.

**Description:**

1. The time period combines TLOW (time low) and THIGH (time high) sections of a DYNAMIC waveform.
2. The value of TLOW and THIGH has to be included the number of the decimal point; otherwise the command will not be available.
3. The least significant number is the fifth after the decimal point.
4. Should a value be entered that is higher than what is possible then the load will automatically set its maximum value according the load module fitted.
5. The engineering unit is ms.

**LDONv****Command Syntax:**

```
[PRESet:] LDONv {SP} {NR2}{ ; | NL}
```

```
[PRESet:] LDONv?{ ; | NL}
```

**Purpose:**

Set and Read the voltage level at which the LOAD will switch ON.

**Description:**

This command is used to set or query the voltage value at which the LOAD will automatically switch ON. The engineering unit is V.

**LDOFv****Command Syntax:**

```
[PRESet:] LDOFv {SP} {NR2} { ; | NL}
```

```
[PRESet:] LDOFv?{ ; | NL}
```

**Purpose:**

Set and read back the voltage level at which the LOAD will switch OFF.

**Description:**

This command is used to set or query the voltage value at which the LOAD will automatically switch OFF. The engineering unit is V.

**CURR : HIGH | LOW****Command Syntax:**

```
[PRESet:] CC | CURR : HIGH | LOW{SP} {NR2}{; | NL}
```

```
[PRESet:] CC | CURR : HIGH | LOW? {; | NL}
```

**Purpose:**

Set or read the HIGH or LOW current levels in Amps.

**Description:**

This command is used to set or query the HIGH and LOW levels of load current allowed. These 2 current levels need to be used if a dynamic load waveform is used. It also allows the user to switch between two preset current levels.

1. The least significant number is the fifth digit after the decimal point.
2. The LOW level current value cannot be higher than the HIGH level.
3. Should a value be entered that is higher than what is possible then the load will automatically set the maximum value according the load module installed.
4. The engineering unit is A.

**CURR****Command Syntax:**

```
[PRESet:] CC | CURR {SP} {NR2}{; | NL}
```

```
[PRESet:] CC | CURR?{; | NL}
```

**Purpose:**

Set or read the load current.

**Description:**

This command is used to set or query the load current.

1. The least significant number is the fifth digit after the decimal point.
2. Should a value be entered that is higher than what is possible then the load will automatically set the maximum value according the load module installed.
3. The engineering unit is A.

**CP: {HIGH | LOW}****Command Syntax:**

```
[PRESet:] CP:{ HIGH | LOW} {SP} {NR2} {; | NL}
```

```
[PRESet:] CP:{ HIGH | LOW}? {; | NL}
```

**Purpose:**

Set and read the operating power value in watts.

**Description:**

This command is used to set or query the HIGH or LOW setting levels of load power. These 2 power levels need to be used should a dynamic load waveform be desired. It also allows the user to switch between two preset power levels.

1. The least significant number is the fifth digit after the decimal point.
2. The LOW level power value cannot be higher than the HIGH level.
3. Should a value be entered that is higher than what is possible then the load will automatically set its maximum value according the load module installed.
4. The engineering unit is W.

**CR | RES:{HIGH | LOW}****Command Syntax:**

```
[PRESet:] CR | RES:{HIGH | LOW} {SP} {NR2} {; | NL}
```

```
[PRESet:] CR | RES:{HIGH | LOW}? {; | NL}
```

**Purpose:**

Set and read the HIGH or LOW resistance levels.

**Description:**

This command is used to set or query the HIGH and LOW levels of load resistance. It allows the user to switch between two resistance levels.

1. The least significant number is the fifth digit after the decimal point.
2. The LOW level resistance value cannot be higher than the HIGH level.
3. Should a value be entered that is higher than what is possible then the load will automatically set its maximum value according the load module installed.
4. The engineering unit is  $\Omega$ .

**CR | RES****Command Syntax:**

[PRESet:] CR | RES {SP} {NR2}{; | NL}

[PRESet:] CR | RES? {; | NL}

**Purpose:**

Set and read the resistance.

**Description:**

This command is used to set or query the load resistance.

1. The least significant number is the fifth digit after the decimal point.
2. Should a value be entered that is higher than what is possible then the load will automatically set its maximum value according the load module installed.
3. The engineering unit is  $\Omega$ .

**CV: {HIGH | LOW}****Command Syntax:**

[PRESet:] CV: {HIGH | LOW} {SP} {NR2}{; | NL}

[PRESet:] CV: {HIGH | LOW}? {; | NL}

**Purpose:**

Set and read the value of DC load voltage.

**Description:**

This command is used to set or query the HIGH and LOW levels of load voltage. It allows the user to switch between two voltage levels.

1. The least significant number is the fifth digit after the decimal point.
2. The LOW level voltage value cannot be below the HIGH level.
3. Should a value be entered that is higher than what is possible then the load will automatically set its maximum value according the load module installed.
4. The engineering unit is V.



**CV****Command Syntax:**

[PRESet:] CV {SP} {NR2}{; | NL}

[PRESet:] CV? {; | NL}

**Purpose:**

Set and read the value of DC load voltage.

**Description:**

This command is used to set or query the load voltage.

1. The least significant number is the fifth digit after the decimal point.
2. Should a value be entered that is higher than what is possible then the load will automatically set its maximum value according the load module installed.
3. The engineering unit is V.

**OCP: START****Command Syntax:**

[PRESet:] OCP:START {SP} {NR2}{; | NL}

[PRESet:] OCP:START? {; | NL}

**Purpose:**

Set and read the initial value of OCP test.

**Description:**

This command is used to set or query the required initial value (I-START) of the OCP test.

**OCP: STEP****Command Syntax:**

[PRESet:] OCP:STEP {SP} {NR2}{; | NL}

[PRESet:] OCP:STEP? {; | NL}

**Purpose:**

Set and read the increasing value of OCP test.

**Description:**

This command is used to set or query the increment value (I-STEP) for the OCP test.

**OCP:STOP****Command Syntax:**

[PRESet:] OCP:STOP {SP} {NR2} {;} | NL}

[PRESet:] OCP: STOP? {;} | NL}

**Purpose:**

Set and read the maximum value of OCP test.

**Description:**

This command is used to set or query the maximum or end value (I-STOP) for the OCP test.

**VTH****Command Syntax:**

[PRESet:] VTH {SP}{NR2}{;} | NL}

[PRESet:] VTH ? {;} | NL}

**Purpose:**

Set and read the value of the Threshold Voltage.

**Description:**

This command is used to set or query the minimum threshold voltage for the OCP/OPP tests. If the measured voltage is below the threshold voltage and the OCP/OPP test started, the test will not run and an error will be flagged.

**OPP:START****Command Syntax:**

[PRESet:] OPP:START {SP} {NR2} {;} | NL}

[PRESet:] OPP:START? {;} | NL}

**Purpose:**

Set and read the initial value of OPP test.

**Description:**

This command is used to set or query setting the initial value (P-START) of the OPP test.

### OPP:STEP

**Command Syntax:**

[PRESet:] OPP:STEP {SP} {NR2} {; | NL}

[PRESet:] OPP:STEP? {; | NL}

**Purpose:**

Set and read the increasing value of OPP test.

**Description:**

This command is used to set or query the power increments, which the OPP test will follow between the P-START and P-STOP values.

### OPP:STOP

**Command Syntax:**

[PRESet:] OPP:STOP {SP} {NR2} {; | NL}

[PRESet:] OPP:STOP ? {; | NL}

**Purpose:**

Set and read the maximum value of OPP test.

**Description:**

This command is used to set or query the maximum power value (P-STOP) of the OPP test.

### TCONFIG

**Command Syntax:**

[PRESet:] TONFIG {NORMAL | OCP | OVP | OPP | SHORT} {; | NL}

[PRESet:] TONFIG ? {; | NL}

**Purpose:**

Set or query the function mode of dynamic test.

**Description:**

There are five options for this command. Those are NORMAL mode, OCP Test, OVP Test, OPP Test and SHORT Mode Test.

## STIME

### Command Syntax:

[PRESet:] STIME {SP} {NR2}{; | NL}

[PRESet:] STIME? {; | NL}

### Purpose:

Set and read time of the short-circuit test.

### Description:

This command is used to set the short-circuit test time. If the time is set to zero, there is no time limit. In other words, a continuous short circuit test will be implemented. If a non-zero value is entered, this is the short circuit duration test time in milliseconds (ms).

## OCP

### Command Syntax:

OCP? {; | NL}

### Purpose:

Query the OCP test current.

### Description:

This command is used to query the OCP current measured in the OCP test.

## OPP

### Command Syntax:

OPP? {; | NL}

### Purpose:

Query the OPP test power level in watt.

### Description:

This command is used to query the OPP power for the OPP test.

### 8.6.2 LIMIT Commands

LIMIT commands are used to set high and low operating limits that can be used in conjunction with the GO/NOGO (NG) function to signal that the load is sinking outside the expected parameters.

**[LIMit:]CURRent:{HIGH | LOW} or IH | IL**

**Command Syntax:**

[LIMit:]CURRent:{HIGH | LOW} {SP} { NR2 } {;} |NL}

[LIMit:]CURRent:{HIGH | LOW}? {;} |NL}

[IH | IL]{SP}{ NR2 } {;} |NL}

[IH | IL]? {;} |NL}

**Purpose:**

Set or query the HIGH / LOW load current limits when operating in CC or CR modes.

**Description:**

This command is used to set or query two current LIMIT values. Operation outside these LIMIT values will cause a No Good (NG) signal to be generated.

1. The LOW level cannot be higher than the HIGH level.
2. If the current taken by the load falls below the LOW limit then a No Good (NG) signal is available.
3. If the current rises above the HIGH limit then the NG signal is available.
4. If the current stays between HIGH and LOW LIMIT levels the NG signal will not be sent.

**[LIMit:]POWer:{HIGH | LOW} or WH | WL**

**Command Syntax:**

[LIMit:]POWer:{HIGH | LOW}{SP}{ NR2 } {;} |NL}

[LIMit:]POWer:{HIGH | LOW}? {;} |NL}

[WH | WL]{SP}{ NR2 } {;} |NL}

[WH | WL]? {;} |NL}

**Purpose:**

Set or query the HIGH / LOW load power limits when operating in CP or CR modes.

**Description:**

This command is used to set two power LIMIT values. Operation outside these LIMIT values will cause a NG signal to be generated.

1. The LOW level cannot be higher than the HIGH level.

2. If the power taken by the load falls below the LOW limit then a No Good (NG) signal is available.
3. If the power rises above the HIGH limit then the NG signal is available.
4. If the power stays between HIGH and LOW LIMIT levels the NG signal will not be sent.

**[LIMit:]VOLTage:{HIGH | LOW} or VH | VL**

**Command Syntax:**

[LIMit:]VOLTage:{HIGH | LOW} {SP} { NR2 }{;}|NL}

[LIMit:]VOLTage:{ HIGH | LOW}? {;}|NL}

[VH | VL] {SP} { NR2 }{;}|NL}

[VH | VL]? {;}|NL}

**Purpose:**

Set or query the HIGH / LOW limits of voltage present at the load terminals.

**Description:**

This command is used to set two voltage LIMIT values. Operation outside these LIMIT values will cause a NG signal to be generated.

1. The LOW level cannot be higher than the HIGH level.
2. If the voltage at the load input falls below the LOW limit then a No Good (NG) signal is available.
3. If the voltage rises above the HIGH limit then the NG signal is available.
4. If the current stays between HIGH and LOW LIMIT levels, the NG signal will not be sent.

**[LIMit : ] SVH | SVL**

**Command Syntax:**

[LIMit:] {SVH | SVL} {SP} {NR2}{;}|NL}

[LIMit:] {SVH | SVL}? {;}|NL}

**Purpose:**

Set or query the upper and lower voltage levels during for short test.

**Description:**

This command is used to set two voltage LIMIT values. If during the short test the voltage is outside these LIMIT values, a NG signal will be generated.

1. The LOW level cannot be higher than the HIGH level.

2. If the voltage at the load input falls below the LOW limit then a No Good (NG) signal is available.
3. If the voltage rises above the HIGH limit then the NG signal is given.
4. If the current stays between HIGH and LOW LIMIT levels, the NG signal will not be sent.

### 8.6.3 STATE Commands

STATE commands can be used to set or query the actual operating status of the electronic load at any time.

**[STATE:] LOAD {SP} {ON | OFF}**

**Command Syntax:**

[STATE:] LOAD {SP} {ON | OFF}; | NL

[STATE:] LOAD? {; | NL}

**Purpose:**

Read LOAD ON or OFF status.

**Description:**

This command is used to see if the Load is ON or OFF. 0 = Load OFF, 1 = Load ON.

**[STATE:] MODE {SP} {CC | CR | CV | CP}**

**Command Syntax:**

[STATE:] MODE {SP} {CC | CR | CV | CP}; | NL

[STATE:] MODE? {; | NL}

**Purpose:**

Set and read the operating mode of LOAD.

**Description:**

The return value is 0 | 1 | 2 | 3 which corresponds to the operating mode that the load is in. i.e. CC|CR|CV|CP.

Mode:	CC	CR	CV	CP
Value:	(0)	(1)	(2)	(3)
Supported	V	V	V	V

**[STATE:] SHORt {SP} {ON | OFF}**

**Command Syntax:**

[STATE:] SHORt {SP} {ON | OFF}; | NL

[STATE:] SHORt? {; | NL}

**Purpose:**

Reads back whether the short circuit test is active or not.



**Description:**

0 = short circuit test active, 1 = short circuit test inactive

**[STATe:] PRESet {SP} {ON | OFF}**

**Command Syntax:**

[STATe:] PRESet {SP} {ON | OFF}; | NL}

[STATe:] PRESet? {; | NL}

**Purpose:**

Reads back whether load is in preset mode.

**Description:**

This command is used to check if the load is in preset mode.

0 = Preset mode OFF, 1 = Preset mode ON

**[STATe:] SENSE{SP} {ON | OFF | AUTO}**

**Command Syntax:**

[STATe:] SENSE {SP}{ON | OFF | AUTO }; | NL}

[STATe:] SENSE? {; | NL}

**Purpose:**

Reads back whether the sense function is ON or OFF.

**Description:**

0 = Sense OFF or Sense AUTO

1 = Sense ON

**[STATe:] LEVel {SP} {HIGH | LOW} or LEV {SP} {HIGH | LOW}**

**Command Syntax:**

[STATe:] LEVel {SP} {HIGH | LOW }; | NL}

[STATe:] LEVel? {; | NL}

[STATe:] LEV {SP} {HIGH | LOW}; | NL}

[STATe:] LEV? {; | NL}

**Purpose:**

Reads back whether the load is operating at its LOW or HIGH LEVEL.

**Description:**

In CC, CR, CV or CP operating modes the user can set two LEVELS of load current, resistance, voltage or power. The load will read back which level it is at:

0 = Load operating at low level

1 = Load operating at high level

**[STATe:] DYNamic {SP} {ON | OFF}**

Command Syntax:

[STATe:] DYNamic {SP} {ON | OFF}; | NL}

[STATe:] DYNamic? {; | NL}

**Purpose:**

Reads back whether the load is operating in STATIC or DYNAMIC mode.

**Description:**

0 = Dynamic operation

1 = Static Operation

**[STATe:] CLR**

**Command Syntax:**

[STATe:] CLR {; | NL}

**Purpose:**

Clears the error flag.

**Description:**

This command is used for clearing the contents of the PROT and ERR registers. After execution, the contents of these two registers will be "0".

**[STATe:] ERRor**

**Command Syntax:**

[STATe:] ERRor? {; | NL}

**Purpose:**

Query if there are any errors flagged in the module.

**Description:**

1. ERR? : Read the register of ERR status. Table 22 shows the corresponding number of ERR status.
2. Use command CLR to clear the register of ERR status to be "0"

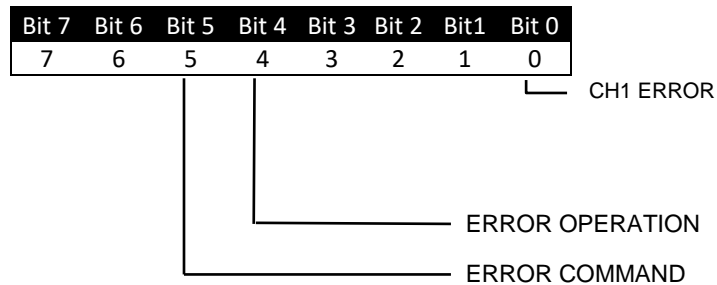

BIT ID	BIT VALUE	REMARK
bit 0-3	0 = Off, 1 = Triggered	CH1 error
bit 4	0 = Off, 1 = Triggered	Operation error
bit 5	0 = Off, 1 = Triggered	Command error (e.g. syntax error)

Table 8-17: Error Register Bits

[STATE:] NG? {; | NL}

**Command Syntax:**

[STATE:] NG? {; | NL}

**Purpose:**

Query if the NG flag is displayed on this module.

**Description:**

This command queries the NG status. If the response is “0”, the LED of NG (NO GOOD) will be off. If the response is “1”, the LED will be lit, showing that the NG flag is present.

[STATE:] PROTECT? {; | NL}

**Command Syntax:**

[STATE:] PROTECT? {; | NL}

**Purpose:**

Query the state of the protection register on this module.

**Description:**

1. PROT? requests the status of the units protection register.
2. Use the command “CLR” to clear the register of PROT status to “0”.

Bit 7	Bit 6	Bit 5	Bit 4	Bit 3	Bit 2	Bit 1	Bit 0
7	6	5	4	3	2	1	0

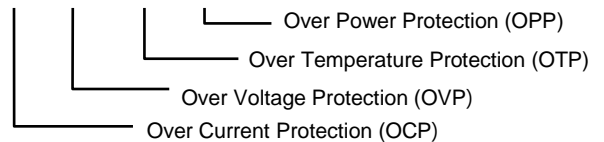

BIT ID	BIT VALUE	REMARK
bit 0	0 = Off, 1 = Triggered	Over Power Protection (OPP)
bit 1	0 = Off, 1 = Triggered	Over Temperature Protection (OTP)
bit 2	0 = Off, 1 = Triggered	Over Voltage Protection (OVP)
bit 3	0 = Off, 1 = Triggered	Over Current Protection (OCP)

Table 8-18: Protection Status Register Bits

**[STATe:] CCR {AUTO | R2}****Command Syntax:**

[STATe:] CCR {AUTO | R2} {; | NL}

**Purpose:**

This command sets the CC MODE RANGE, forcing RANGE II operation if required.

**Description:**

Switches the unit between AUTO RANGE and RANGE II. AUTO RANGE will allow the unit to move to a more precise range at low currents, while forcing the unit to remain in RANGE II keeps the range consistent regardless of the current level.

**[STATe:] POLAR {POS | NEG}****Command Syntax:**

[STATe:] POLAR {POS | NEG} {; | NL}

**Purpose:**

Sets the polarity displayed by the voltage meter.

**Description:**

The voltage read-out can be set to POS for positive, and NEG for negative polarity display.

**[STATe:] START****Command Syntax:**

[STATe:]START {; | NL}

**Purpose:**

Set for load to begin the test.

**Description:**

Begins the test, according to the TEST CONFIG (TCONFIG). The load module will start to test based on the items and parameters stored.

**[STATe:] STOP****Command Syntax:**

[STATe:]STOP {; | NL}

**Purpose:**

Stops a test, if one is in progress.

#### 8.6.4 SYSTEM Commands

SYSTEM commands allow the user to read the model number of the load and turn RS232 remote control ON and OFF. Commands are also available for storing and retrieving load set-ups saved in the memory of the load. The load has 150 separate memory locations. This is comprised of 15 memory BANKS with each bank having 10 STATES.

All 5P Series Models	
<b>BANK (n)</b>	15
<b>STATE (m)</b>	10
<b>Total States / Mem. Locations</b>	150

#### [SYStem:] RECall {SP} { m } [, n]

##### Command Syntax:

[SYStem:] RECall {SP} {m} [, n] {; | NL}

##### Purpose:

Recalls the load set-up, which has been previously saved in memory.

##### Description:

This command is for recalling the procedure stored in a specified memory location where:

m = STATE, 1 through 10

n = BANK, 1 through 15

If the memory STATE to be used is from the currently selected BANK as shown on the mainframe's display, then the BANK [n] can be omitted.

For example:

RECALL 2,15    Recalls the load set up saved in the 2nd STATE and 15th BANK of the memory.

REC 3    Recalls the load set up from the 3rd memory STATE from the current BANK as shown on the units front panel display.

#### [SYStem:] STORe {SP} {m}[, n]

##### Command Syntax:

[SYStem:] STORe {SP} {m} [, n] {; | NL}

##### Purpose:

Saves the load's status to the unit's memory.

##### Description:

This command is for saving the current set up to a specified memory location where:

m = STATE, 1 through 10

n = BANK, 1 through 15

If the memory STATE to be saved to the currently selected BANK then the BANK [n] part of the command can be omitted.

For example:

STORE 2, 15 Saves the status of the load to the 2nd STATE of the 15th memory BANK.

STOR 3 Saves the load setup to the 3rd memory STATE of the current BANK as shown on the units front panel display.

**[SYStem:] NAME?**

**Command Syntax:**

[SYStem:] NAME? {; | NL}

**Purpose:**

Returns the model number of the load.

**Description:**

This command is for reading the model number of the load. The model number length is limited to 5 characters. The model number will be returned as per Table 8-19.

APS-Model	Return Value
5P024-24	APS_5P024-24
5P024-48	APS_5P024-48
5P036-24	APS_5P036-24
5P036-48	APS_5P036-48
5P036-72	APS_5P036-72
5P054-36	APS_5P054-36
5P054-72	APS_5P054-72
5P054-99	APS_5P054-99
5P072-48	APS_5P072-48
5P072-96	APS_5P072-96
5P090-60	APS_5P090-60
5P108-72	APS_5P108-72
5P126-84	APS_5P126-84
5P144-96	APS_5P144-96

Table 8-19: 5P Series Load Model Name Return Values

**[SYSTem:] \*RST**

**Command Syntax:**

[SYSTem:] \*RST {; | NL}

**Purpose:**

Load reset.

**Description:**

This command resets the load to its default state.

**[SYSTem:] REMOTE**

**Command Syntax:**

[SYSTem:] REMOTE {; | NL}

**Purpose:**

Command to enter REMOTE status (only for RS232, USB or LAN).

**Description:**

This command is for enabling control of the unit via RS232, USB or LAN.

**[SYSTem:] LOCAL**

**Command Syntax:**

[SYSTem:] LOCAL {; | NL}

**Purpose:**

Command to exit the REMOTE status (only for RS232)

**Description:**

This command closes the RS232 control interface.

**SYNC:LOAD {SP} {ON | OFF}**

**Command Syntax:**

SYNC:LOAD {SP} {ON | OFF} {; | NL}

**Purpose:**

Command to enable or disable all electronics loads in the mainframe at the same time.

Example: SYNC:LOAD ON

SYNC:LOAD OFF



### 8.6.5 MEASUREMENT Commands

Measurement commands allow measurement data for each module to be retrieved.

#### **MEASure:CURRent?**

##### **Command Syntax:**

MEASure:CURRent? {; | NL}

##### **Purpose:**

Measures the load current.

##### **Description:**

Reads the current meter data. The engineering unit is Ampere (A).

#### **MEASure:VOLtage?**

##### **Command Syntax:**

MEASure:VOLtage? {; | NL}

##### **Purpose:**

Measures the load voltage.

##### **Description:**

Reads the voltmeter data. The engineering unit is Voltage (V).

#### **MEASure:POWer?**

##### **Command Syntax:**

MEASure:POWer? {; | NL}

##### **Purpose:**

Reads the power being absorbed by the load.

##### **Description:**

Reads the power meter data. The engineering unit is Watt (W).

## 8.7 IEEE488.2 Common Commands

The following IEEE488.2 common commands (a.k.a. star commands) are supported by the load.

### 8.7.1 \*IDN?

Command Syntax:

**\*IDN? {; | NL}**

Purpose: Returns the load Identity string.

Description: This command is similar to the MODEL command but returns the response in a SCPI format. The response contains several four fields separated by a comma.

Query response: Manufacturer, load model number and controller firmware revision.

Example: APS,5P024-24,1.0

### 8.7.2 \*RST

Command Syntax:

**\*RST {; | NL}**

Purpose: The \*RST command (reset) has the same effect as an IEEE-488 Device Clear bus command but can be used over the RS232C interface as well. This command resets the load to its power on default state.

## 9 USB Driver Installation

### 9.1 Overview

The load may be equipped with a USB interface. To communicate with this interface, a USB device driver is required on a Windows PC. This appendix describes the driver installation process for the PL-2303 USB to Serial Driver. Once installed, the USB port will appear as a COM port to the Windows Operating System.

### 9.2 USB Driver Installation

To install the USB device driver, proceed as follows:

1. Insert the supplied CD ROM into a CD Rom drive.
2. If configured for auto-start, the driver installation program will launch. If not, run “USB\SETUP\PL-2303 Driver Installer.exe” from the CD Rom drive.
3. This will open the first installation wizard screen.

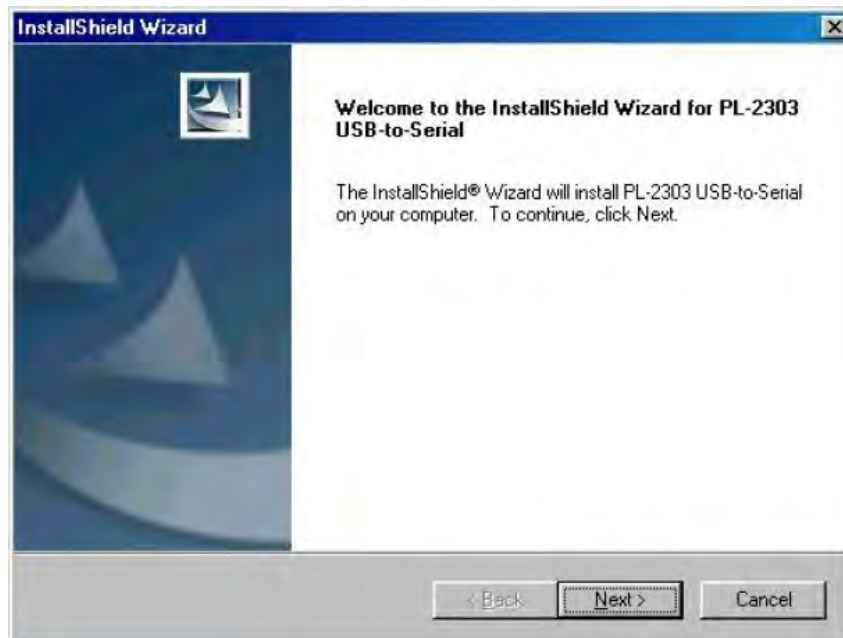

4. Follow the on-screen prompts.



5. After the installation completes, open the Windows Control Panel from the Start menu and select "Device Manager".
6. In the Device Manger Listing, locate the "Ports (COM & LPT)" entry

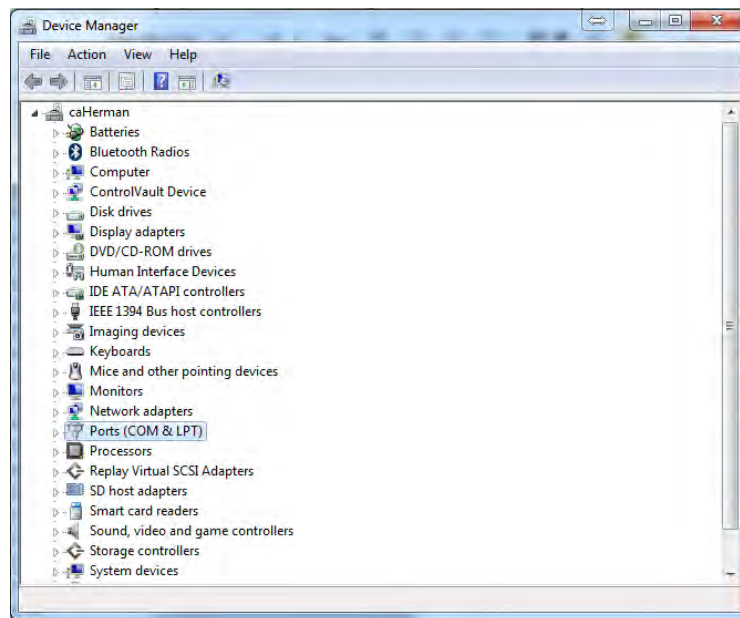

7. One of the entries should show "USB to Serial Port (COMx) with x any value higher than 2.
8. Note the Com port number at which the USB device is located. Right click on this Com port and select "Properties".
9. In the Properties dialog box, select "Port Settings".

10. Select the relevant COM port and set Bit per second (baud rate) to “115200” and Flow control “Hardware”.

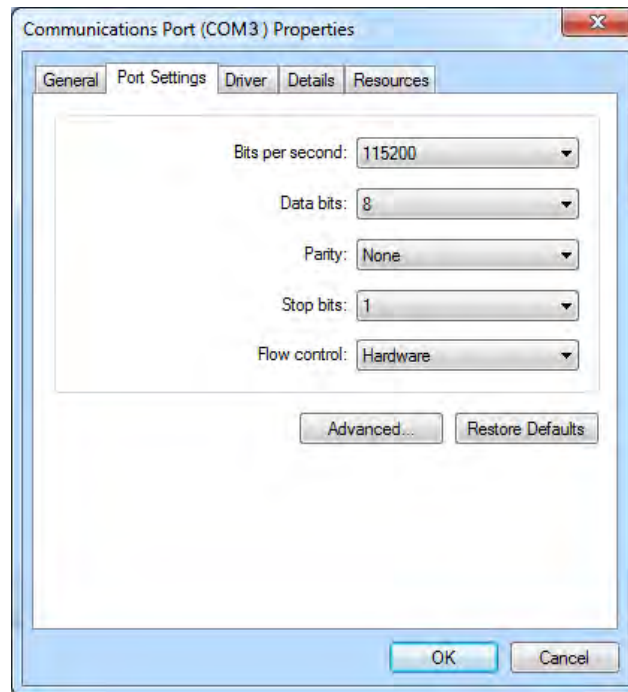

11. Connect the load to the PC using a suitable USB cable. (not supplied with the load).
12. You should now be able to communicate with the load through COMn.

## 10 LAN Driver Installation

### 10.1 Overview

The load may be equipped with a LAN (Ethernet) interface. To communicate with this interface, an Ethernet Manager Utility program is supplied with the LAN interface. This appendix describes the use of this utility to establish a network connection with the load under Windows.

### 10.2 Factory Default IP Address Setting

All Ethernet Interface cards are shipped from the factory set to a fixed, static IP address. The factory IP setting is:

**192.168.16.128**

This setting can be changed using the IP Scanner utility and

To access the LAN interface, your PC will have to be set to a Static IP address with the first three octets matching the LAN card setting or 192.168.16.xxx. The last octet must be different from 180 to avoid a conflict. Thus, DHCP must be turned off.

Using a direct PC to Load CAT5 LAN cable, connection to the instrument can now be made. To do so, download the IP Scanner Utility program per next section.

For instructions on how to set a static IP address under Windows 10, see Section 11.5, “Setting a static IP address on Windows 10 PC” on page 146.

### 10.3 Download IP Scanner Utility Program File

The LAN driver for APS loads is available from the Technical Resources page on the Adaptive Power Website. Registration is required but access is granted via email reply immediately.

<https://tr.adaptivepower.com>

Download the APS\_Loads-LAN\_IPScanner.zip file as indicated in the figure below.

APS\_Loads-LAN\_IPScanner

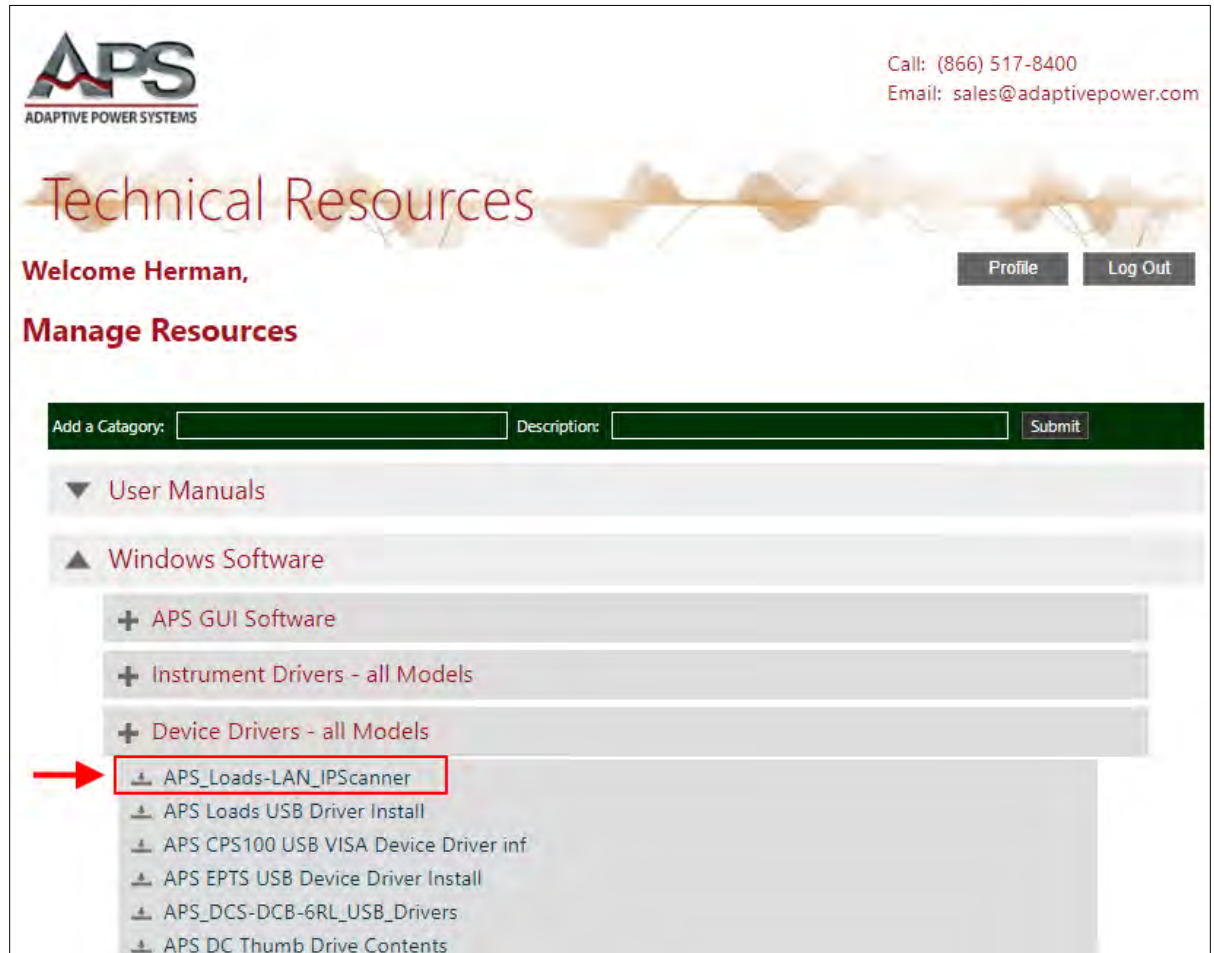

Figure 11-1: LAN IP Scanner Utility Program Download

The file name is **APS\_Loads-LAN\_IPScanner.zip**. This compressed archive contains the driver installation program.

## 10.4 LAN Setup

To establish an Ethernet connection between a PC on your network and the load, proceed as follows:

1. Connect AC power and the network (LAN) CAT5 cable to the load.
2. Connect the other side of the network cable to an existing Ethernet network.
3. Unzip and run the APS\_Loads-LAN\_IPScanner utility program. It will be necessary to allow access past your Windows Firewall.

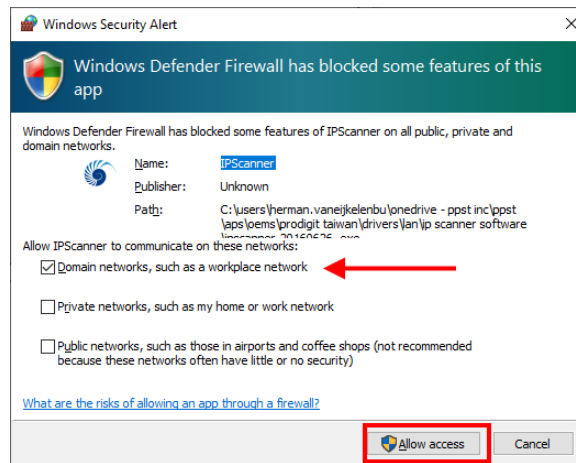

4. The IP Scanner screen will be displayed as shown below. If the APS Load IP address does not appear in the top window, press F5 or view refresh to search again (refresh), and check the LAN connections if necessary.

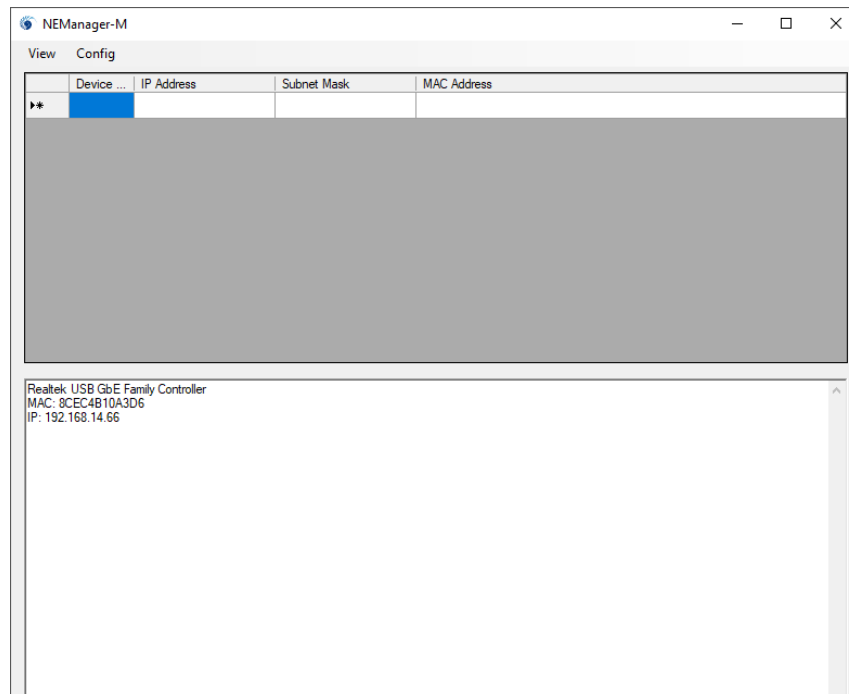



5. The connected unit should appear on the list indicating connection to the instrument is established.
6. At this point, the Controller Setup page should be accessible, once everything is set correctly. This allows greater control over the communications interface.

Controller Setup				
IP Address	192.168.16.128			
Subnet mask	255.255.255.0			
Gateway address	0.0.0.0			
Network link speed	Auto			
DHCP client	Enable			
Socket port of HTTP setup	80			
Socket port of serial I/O	4001	TCP Server		
Socket port of digital I/O	5001	TCP Server		
Destination IP address / socket port (TCP client and UDP) Connection	0.0.0.0	0 Auto		
TCP socket inactive timeout (minutes)	0			
Serial I/O settings (baud rate, parity, data bits, stop bits)	115200	N	8	1
Interface of serial I/O	RS 232 (RTS/CTS)			
Packet mode of serial input	Disable			
Device ID	1			
Report device ID when connected	Disable			
Setup password				
UPDATE				

Insert the following into the controller set up screen:

1. IP Address: as recommended according to your network or leave **blank** if you select to use DCHP in step 5 below.
2. Subnet Mask: as recommended according to your network
3. Gateway Address: as recommended according to your network
4. Network link speed: Auto
- 5. DHCP client - change to: Enable**
6. Socket port of HTTP setup: 80
7. Socket port of serial I/O: 4001, TCP Server
8. Socket port of digital I/O: 5001, TCP Server
9. Destination IP address / socket port (TCP client and UDP) Connection: Auto
10. TCP socket inactive time out (minutes): Set the network disconnection after N minutes, setting 0 minutes will work forever (no time-out).
11. Serial I/O settings (baud rate, parity, data, bits, stop bits): 115200, N, 8, 1
- 12. Interface of serial I/O: RS 232 (RTS/CTS)**
13. Packet mode of serial input: Disable
14. Device ID: 5
15. Report device ID when connected:Auto
16. Setup password: Not required

If you experience difficulties establishing a connection, contact your network administrator for assistance. Network security setting may prevent you from connecting properly.

## 10.5 Setting a static IP address on Windows 10 PC

To connect to a factory configured LAN interface, it is necessary to set your Windows 10 PC to a fixed IP address with the same subnet mask as the factory default IP address, 192.168.16.128. This section outlines the steps needed to do so. Once connected, you can change the LAN interface to DHCP mode and reconnect to your in-house Ethernet LAN.

To access network setting, right-click on the Windows symbol in the lower left corner of the screen and select “Network Connections”.

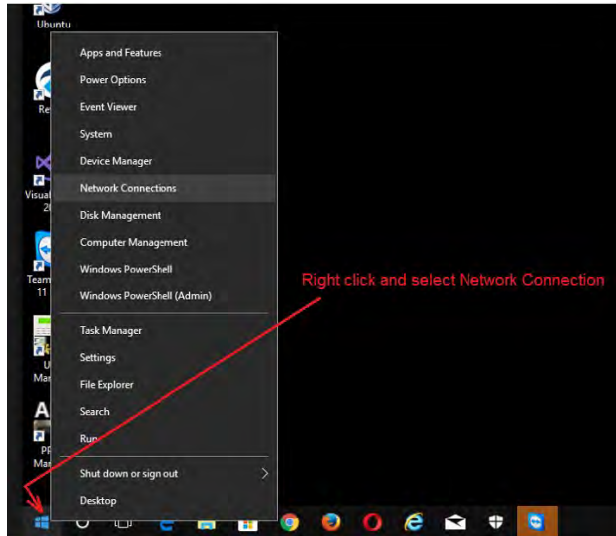

This will display the network setting screen shown below.

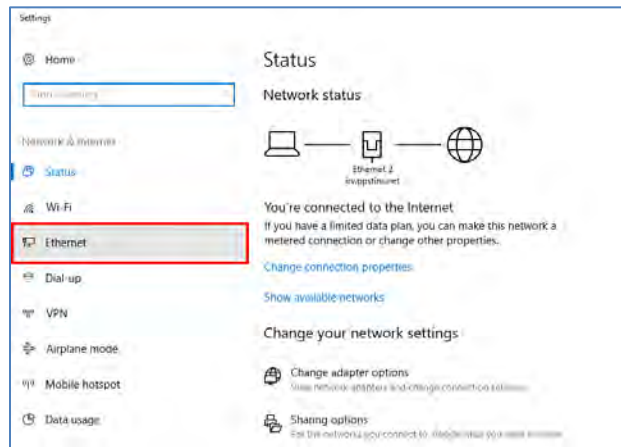

Under Related Settings, select “Change Adaptor” options. This selection may also appear on the right hand side of the screen on larger displays.

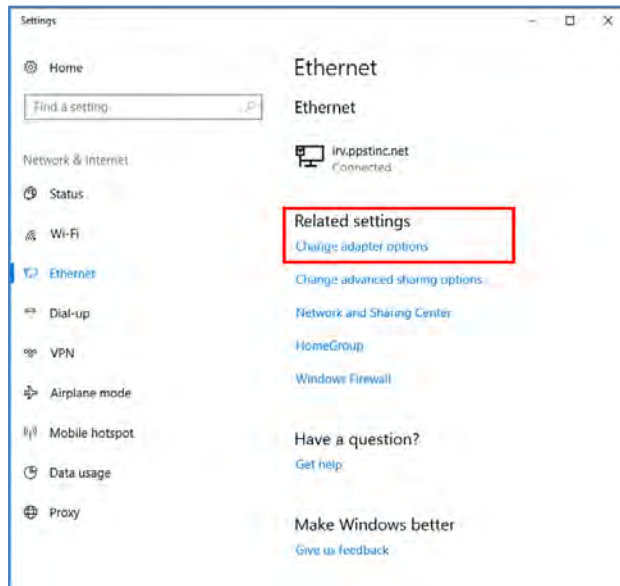

The Change Adaptor options screen will display all available network adaptors on you PC. Choose the regular LAN connector adaptor by right clicking on it and selecting it, in this example, “Ethernet 2”.

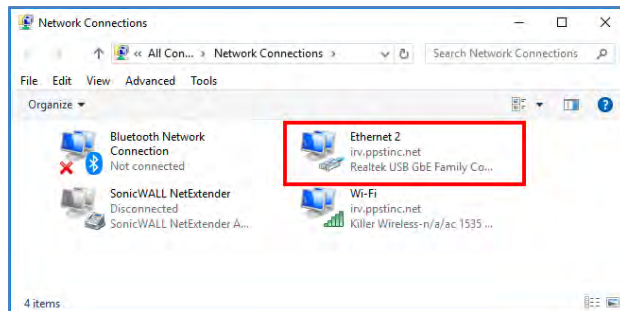

Select the “Internet Protocol Version 4 (TCP/IPv4)” entry in the list as shown below.

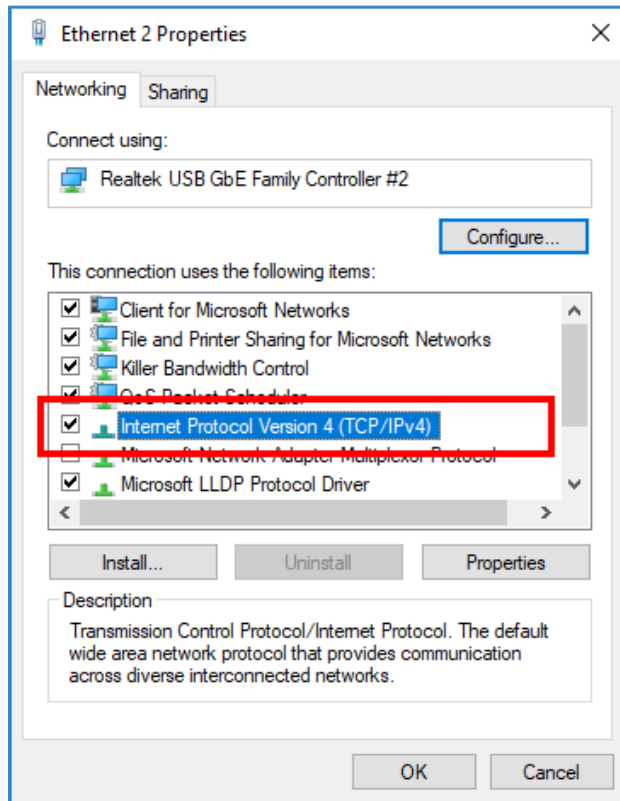

This will bring up the TCP/IP Setting screen shown below.

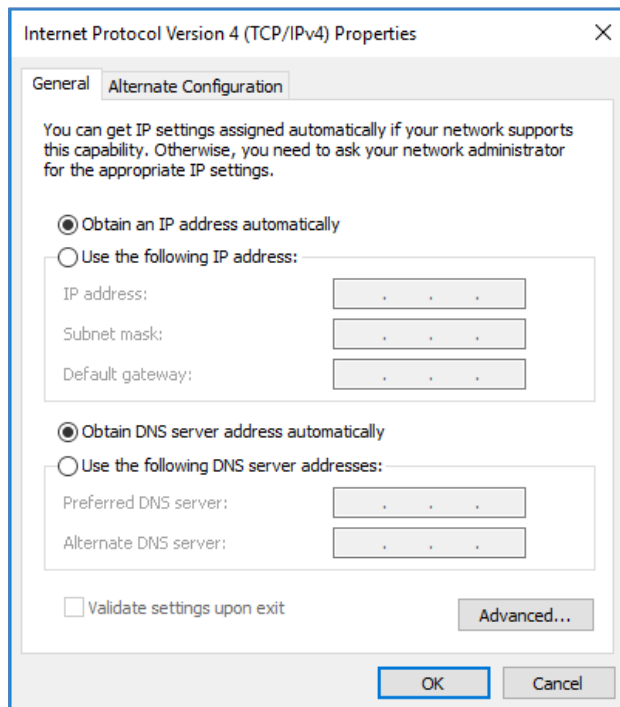

Select the “Use the following IP address:” radio button and enter a static IP address. Use a subnet mask as shown below and a default gateway that matches the IP address except for the last octet. Then click the OK button.

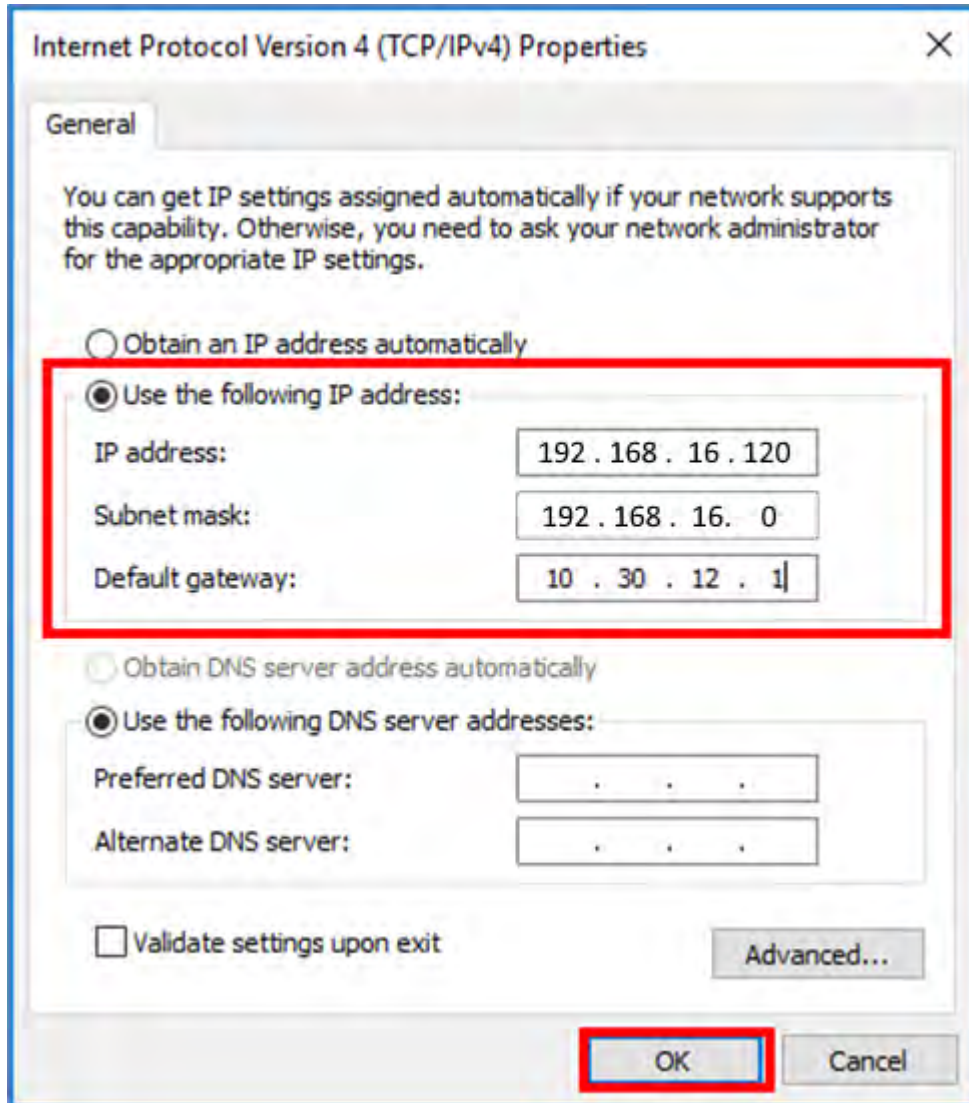

Close the Network setting screens as the fixed IP PC setup is complete. Connect a CAT5 Cable between the PC and the instrument to connect to it.

## 11 Auto Sequence Programming Examples

### 11.1 Overview

An auto-sequence allows the user to step through previously saved set-ups stored in the mainframe's memory. Up to nine auto-sequences can be saved. Each auto-sequence can consist of up to sixteen steps. There are two modes available for the auto-sequence function. These are **edit mode** - to set up an auto-sequence and **test mode** - to recall and start an auto-sequence execution.

### 11.2 Edit Mode

To set up a new auto-sequence using the Edit mode, proceed as follows:

1. Set-up all load parameters such as the operating mode, along with sink values and the LOAD ON/OFF status. Configuration and limit settings can also be set and the NG ON function may be selected as part of the setup.
2. Press the STORE key and one of the numbered STATE keys to store the set up in one of the memory locations. The BANK number can also be changed to provide additional memory locations.
3. Repeat the previous steps as needed to create additional load set-ups and saved them to separate memory locations using the STORE, BANK and STATE keys.
4. Once the required number of load setups has been saved enter the EDIT mode by pressing the EDIT key. The EDIT key will light up indicating the EDIT mode is active.
5. With the EDIT button lit, the auto-sequence identity (F1 to F9) can be selected using the numbered STATE keys.
6. Now select the first memory location by pressing the up/down arrow keys to select the BANK and STATE. This will become the first step of the AUTO-SEQUENCE.
7. Press ENTER to set the chosen BANK and STATE memory location.
8. Using the arrow keys set the test time (T1) and NG/LIMIT checking time (T2) for that step of the auto-sequence.
9. Press ENTER to save the time setting and move onto the next step of the auto-sequence.
10. Repeat steps 6 to 9 to as needed to enter up to 16 steps to form the auto-sequence.
11. Once the desired number of steps have been set, press the STORE button.
12. The LCD will show REP (repetitions).
13. Use the arrow keys to set the number of auto-sequence repetitions.
14. Press STORE to confirm the sequence edit.

This completes the programming sequence.

### 11.3 Test Mode

To execute a previously stored auto-test sequence, proceed as follows:

1. Press the TEST key on the mainframe to enter the TEST mode.
2. Use the numbered STATE keys (1 to 9) to select the previously saved auto-sequence.
3. Press ENTER to start the auto-sequence.
4. The LCD shows "PASS" or "FAIL" after testing.  
If limits and the NG functions have been set and a test step fails, the mainframe LCD display will flash "NG". The user must then press ENTER to continue the auto-sequence execution or EXIT to abort the auto-sequence.
5. Press Auto-sequence or EXIT at any time to abort an auto-test sequence.

### 11.4 AUTO TEST SEQUENCE Example

In this example, we will create a program based on following illustration of a varying current over time. A total of eight sequence steps will be needed to implement this sequence. The program executes steps 1 to 8 in sequence.

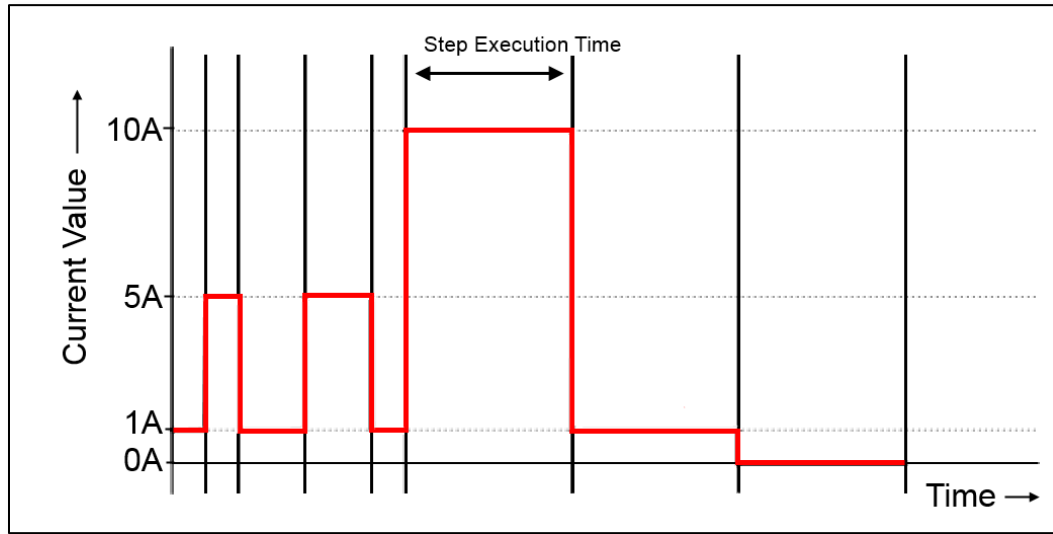

Figure 11-1 Auto-Test Sequence Example Illustration

The desired current levels and durations are shown in the table below.

Auto-sequence Step number	Memory BANK	Memory STATE	Current Value	Execution Time (T1+T2)
1	3	1	1.0 Adc	200 ms
2	3	2	5.0 Adc	200 ms
3	3	3	1.0 Adc	400 ms
4	3	4	5.0 Adc	400 ms
5	3	5	1.0 Adc	200 ms
6	3	6	10.0 Adc	1000 ms
7	3	7	1.0 Adc	1000 ms
8	3	8	0.0 Adc	1000 ms

Table 11-1: Auto-Test Sequence Example Values



To program this sample sequence, proceed as follows:

1. Set the operation mode: Press the mode key to CC mode.
2. Set the range: Press RANGE key to force range 2.
3. Set LOAD ON/OFF Status: Press load ON.
4. Set the current values steps 1-8 and store to memory BANK 3 STATES 1-8.
5. Press EDIT key.
6. Press the number 2 key to select F2 as the auto sequence location.
7. Press up/down key to memory bank 3 and state 1.
8. Press ENTER key to confirm the sequence memory.
9. Press up/down key to set the test time for that step (T1+ T2).
10. Press ENTER key to confirm the sequence step.
11. Repeat steps 7 to 10 to set auto-sequence steps 1-8.
12. After setting the final step, press the STORE key.
13. Press up/down key to 1 to repeat the auto-sequence one time.
14. Press STORE key to confirm the number of repetitions.
15. Press TEST key to enter TEST mode.
16. Press number 2 to select auto-sequence F2.
17. Press ENTER to confirm selection and start TEST.
18. The load will now step through the auto-sequence.

The current test waveform can be checked on an oscilloscope as shown below - assuming that the DC source can supply the programmed load currents.

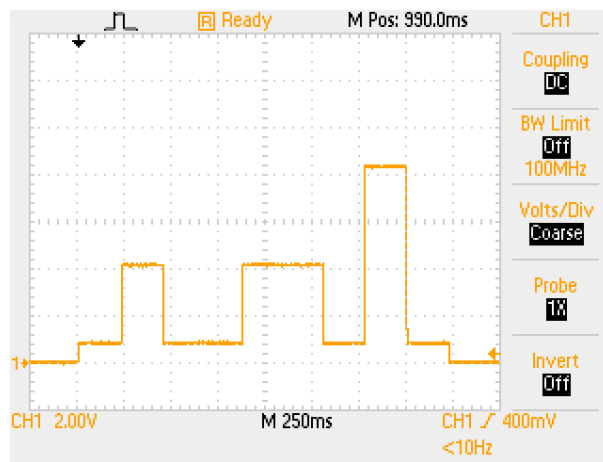

## 12 Short Circuit, OPP and OCP Test Examples

### 12.1 Overview

This appendix provides examples on how to program the built-in test modes of the 5 Series loads. These tests allow commonly used functional testing of power supplies with minimal programming effort.

The parameters for the Short, Over Power Protection and Over Current Protection tests can all be programmed over the optional computer interfaces. The following examples may prove useful.

### 12.2 SHORT Test

To invoke short circuit testing of a unit under test, send the following sequence of commands to the load:

#### SHORT Test

This example sets a short test for 500ms until the STOP command is received.

REMOTE	Set Remote
TCONFIG SHORT	Set SHORT test function
STIME 500	Sets short time to 500ms time*
START	Start SHORT testing
TESTING?	Ask Testing? 1:Testing, 0:Testing End
STOP	Stop SHORT testing

\* if 500 is replaced with 0 the short test is continuous until STOP command

### 12.3 OPP Test

To invoke over power protection circuit testing of a unit under test, send the following sequence of commands to the load:

#### OPP Test

In this example, threshold limits are set and the NG signal is enabled.

REMOTE	Set Remote	
TCONFIG OPP	Set OCP test	
OPP:START 3	Set start load watt 3W	
OPP:STEP 1	Set step load watt 1W	
OPP:STOP 5	Set stop load watt 5W	
VTH 0.6	Set OPP VTH 0.6V	
WL 0	Set watt low limit 0W	
WH 5	Set watt high limit 5W	
NGENABLE ON	Set NG Enable ON	
START	Start OPP testing	
TESTING?	Ask Testing?	1:Testing, 0:Testing End
NG?	Ask PASS/FAIL?	0:PASS,1:FAIL
OPP?	Ask OPP watt value	
STOP	Stop OPP testing	

## 12.4 OCP Test

To invoke over current protection circuit testing of a unit under test, send the following sequence of commands to the load:

### OCP Test

This test will start sinking current at 3A and increase to 5A in 1A steps.

REMOTE	Set Remote
TCONFIG OCP	Set OCP test
OCP:START 3	Set start load current 3A
OCP:STEP 1	Set step load current 1A
OCP:STOP 5	Set stop load current 5A
VTH 0.6	Set OCP VTH 0.6V
IL 0	Set current low limit 0A
IH 5	Set current high limit 5A
NGENABLE ON	Set NG Enable ON
START	Start OCP testing
TESTING?	Ask Testing? 1:Testing, 0:Testing End
NG?	Ask PASS/FAIL?,0:PASS,1:FAIL
OCP?	Ask OCP current value
STOP	Stop OCP testing.

## 13 CE MARK Declaration of Conformity

**Directive:** 2004/108/EC  
**Product Name** 5P Series DC Electronic Loads  
**Serial Number** \_\_\_\_\_

The manufacturer hereby declares that the products are in conformity with the following standards or other normative documents:

**SAFETY:**  
Standard applied IEC 61010-1:2001

**EMC:**  
Standard applied EN 61326-1:2006

**Reference Basic Standards:**

**EMISSIONS:**  
CISPR11: 2003+A1: 2004+A2: 2006  
EN 61000-3-2: 2006  
EN 61000-3-3: 2008

**IMMUNITY:**  
IEC 61000-4-2: 2008  
IEC 61000-4-3: 2008  
IEC 61000-4-4: 2004 +Corr.1: 2006 +Corr.2: 2007  
IEC 61000-4-5: 2005  
IEC 61000-4-6: 2003+A1: 2004+A2: 2006  
IEC 61000-4-8: 2001  
IEC 61000-4-11: 2004

**Supplemental Information:**

**When and Where Issued:** March 28, 2014  
Irvine, California, USA

**Authorized Signatory** Loc Tran  
Quality Assurance Inspector  
Adaptive Power Systems

**Responsible Person** Joe Abranko  
Adaptive Power Systems  
17711 Fitch  
Irvine, California, 92649, USA



**Mark of Compliance**

## 14 RoHS Material Content Declaration

The table below shows where these substances may be found in the supply chain of APS's products, as of the date of sale of the relevant product. Note that some of the component types listed above may or may not be a part of the enclosed product.

Part Name	Hazardous Substance					
	<i>Pb</i>	<i>Hg</i>	<i>Cd</i>	<i>Cr6+</i>	<i>PBB</i>	<i>PBDE</i>
PCB Assy's	x	0	x	0	0	0
Electrical Parts not on PCB Assy's	x	0	x	0	0	0
Metal Parts	0	0	0	x	0	0
Plastic Parts	0	0	0	0	x	x
Wiring	x	0	0	0	0	0
Packaging	x	0	0	0	0	0

### Legend:

0: Indicates that the concentration of the hazardous substance in all homogeneous materials in the parts is below the relevant RoHS threshold.

x: Indicates that the concentration of the hazardous substance of at least one of all homogeneous materials in the parts is above the relevant RoHS threshold.

### Notes:

1. APS has not fully transitioned to lead-free solder assembly at this point in time. However, the vast majority of components used in production are RoHS compliant.
2. These APS products are labeled with an environmental-friendly usage period in years. The marked period is assumed under the operating environment specified in the product specifications.

Example of marking for a 10 year period.



## Index

<b>A</b>	
AC Input .....	25, 46, 49
Accessories.....	20
<b>B</b>	
Bank .....	75, 76
<b>C</b>	
Configuration.....	150
Connections .....	98
Constant Current.....	14, 16, 19, 22, 24, 25, 54, 55, 58, 59, 60, 61, 62, 64, 87, 88, 89, 90, 91, 92, 93, 99, 118, 125, 128, 130, 133, 153
Constant Power	14, 15, 19, 22, 54, 58, 59, 60, 61, 62, 65, 87, 88, 89, 90, 91, 92, 93, 99, 119, 125, 128, 130
Constant Resistance.....	14, 15, 22, 58, 59, 60, 61, 62, 68, 87, 88, 89, 90, 91, 92, 93, 99, 106, 119, 120, 125, 128, 130
Constant Voltage ....	14, 15, 22, 58, 59, 60, 61, 62, 87, 88, 89, 90, 91, 92, 93, 99, 100, 120, 121, 128, 130
Contact .....	9, 50, 52
Contents .....	3
Cooling .....	25
<b>D</b>	
Display.....	60, 61, 68, 74, 75
Displays.....	74
Dynamic mode.....	61
<b>F</b>	
Features .....	19, 94, 101
Frequency .....	17
Front panel operation.....	59
Fuse.....	47, 48
<b>G</b>	
Go/NoGo.....	58
<b>I</b>	
Installation.....	10, 46, 78, 139, 142
<b>L</b>	
LED61, 62, 63, 64, 65, 132	
Level.....	62
<b>O</b>	
OCP test .....	60, 61, 64, 121, 122, 124, 155, 156
OPP test.....	60, 61, 65, 66, 122, 123, 124, 155
<b>P</b>	
Parallel operation.....	99
Programming.....	54, 57, 103, 105, 150
Protection.....	23, 94, 101, 102, 132, 154
<b>S</b>	
Series operation .....	99
Short test.....	60, 61, 63
Size 94	
Slew rate .....	17
Specifications.....	21, 55, 96
State.....	74, 113, 115
<b>T</b>	
Terminals .....	94, 95
Turn on.....	50
<b>W</b>	
Warranty .....	10
Waveform .....	17
Weight.....	25, 26









# **ADAPTIVE** Power Systems

Worldwide Supplier of Power Equipment