

Operation Manual

DCS Series – Rev 1.7 P/N 160934-10

DCS Series Programmable DC Power Supply



ADAPTIVE Power Systems

Worldwide Supplier of Power Equipment

Copyright © 2024, Adaptive Power Systems, Inc. (APS) • All Rights Reserved • No reproduction without written authorization from APS.

PAGE LEFT INTENTIONALLY LEFT BLANK FOR HARDCOPY VERSIONS OF THIS DOCUMENT



Table of Contents

1	Contact Information	9
2	Warranty, Service and Safety Information	10
2.1	General.....	10
2.2	Limited Warranty	10
2.3	Service and Spare Parts Limited Warranty	10
2.4	Equipment Disposal.....	10
2.5	Safety Information.....	11
2.6	Safety Notices	13
2.7	Intended Usage	15
3	Product Overview	16
3.1	General Description.....	16
3.2	Product Features	17
3.3	Block Diagram	17
3.4	Operating Modes	18
3.4.1	Constant Voltage (CV) Mode	18
3.4.2	Constant Current (CC) Mode	19
3.4.3	Constant Power (CP) Mode.....	19
3.4.4	Internal Resistance (IR) Mode.....	20
3.5	Alarm Conditions	21
3.5.1	Power Fail.....	21
3.5.2	Over Temperature Protection	21
3.5.3	Over Voltage Protection.....	21
3.5.4	Over Current Protection.....	22
3.5.5	Over Power Protection.....	22
3.6	Accessories Included	23
3.7	Remote Control Interfaces.....	24
3.7.1	USB Interface (standard)	24
3.7.2	Ethernet Interface (standard on 4U models).....	24
3.7.3	Interface Module Slot.....	24
3.7.4	Analog Interface.....	25
3.7.5	Share Connections.....	25
3.7.6	Voltage Sense Connections (Remote Sense)	25
3.7.7	Master-Slave Bus	26
3.7.8	GPIB Interface Option.....	26
3.8	Other Options	26
4	Technical Specifications	28
4.1	5kW 3U Models – 208Vac Input (-2)	28
4.2	10kW 3U Models –208Vac Input (-2)	30
4.3	15kW 3U Models –208Vac Input (-2)	32
4.1	15kW 4U Models – 208Vac Input (-2)	36
4.2	5kW 3U HP Models – 208V~480Vac Input (-4).....	37
4.3	5kW 3U Models – 380V~480Vac Input (-4)	38
4.4	10kW 3U HP Models – 208V~480Vac Input (-4).....	40
4.5	10kW 3U Models – 380V~480Vac Input (-4)	41
4.6	15kW 3U HP Models – 208V~480Vac Input (-4).....	43
4.7	15kW 3U Models – 380V~480Vac Input (-4)	44
4.8	30kW 4U Models – 380V~480Vac Input (-4)	48

4.9	Mechanical Chassis Outlines – 3U Models.....	52
4.1	Mechanical Chassis Outlines – 4U Models.....	54
4.1.1	Water Cooled Version – 4U.....	56
5	Unpacking and Installation	58
5.1	Packaging	58
5.2	Inspection	58
5.3	Ship Kit	59
5.4	Check AC Line Voltage.....	60
5.5	Rear Panel Connections	60
5.6	AC Input Connections.....	60
5.6.1	Mains Supply.....	60
5.6.2	Wire Sizing – 208V AC Input “-2” Models.....	61
5.6.3	Wire Sizing – 380V~480V AC Input “-4” Models.....	61
5.6.4	AC Line Cord – 208Vac “-2” Models	61
5.6.1	AC Line Cord – 380V~480Vac “-4” Models.....	62
5.6.2	Strain Relief and plug fixture	64
5.6.3	Grid Connection Variations.....	64
5.6.4	Suggestions for phase assignments:.....	64
5.6.5	AC Input Fuses	66
5.7	Grounding Requirements	67
5.8	Rack Mounting.....	67
5.9	Bench Use	68
5.10	Loads Connections	68
5.10.1	Recommended Wire Size	68
5.10.2	DC Terminal Types.....	68
5.10.3	Output Cable Safety Covers	69
5.10.4	DC Output Grounding.....	70
5.10.5	Remote Voltage Sense Connections.....	70
5.11	Analog Interface Connections.....	72
5.12	Optional Interface Module Installation.....	72
5.12.1	Before Installation	72
5.12.2	Procedure.....	72
5.13	Share Bus Connections.....	73
5.14	Slave Units.....	73
5.15	Firmware Update	74
5.16	Cleaning.....	74
5.17	In Case of Malfunction	75
6	Front Panel Operation	76
6.1	Front Panel Layout	76
6.2	Touch Screen Display	77
6.2.1	Settings.....	78
6.2.2	General display and setting ranges:.....	78
6.2.3	Status Display.....	78
6.2.4	Rotary Knob Assignments	79
6.2.5	Rotary Knob Operation	79
6.2.6	Available resolutions by voltage models:.....	79
6.3	Front Panel USB Port.....	80
6.4	Manual Operation	81
6.4.1	Turn On the Power Supply	81
6.4.2	Turn Off the Power Supply.....	81

6.4.3	MENU System Overview	81
6.4.4	Adjustment or User Limits	94
6.4.5	Changing Operating Modes	94
6.4.6	Manual Adjustment of Set Values	95
6.4.7	Switching the main screen view	96
6.4.8	Metering / Read back Displays	97
6.4.9	Turning Output DC ON or OFF	97
6.4.10	Saving data to USB Memory Device (Data Logging)	98
6.5	Quick Menu (4U Models only).....	100
6.6	The Graph Display	101
6.7	Remote Control	102
6.7.1	General Analog I/O Info.....	102
6.7.2	Control Locations.....	102
6.7.3	Remote Control using Analog Interface (AI)	103
6.8	Alarms and Monitoring	109
6.8.1	Definition of Terms.....	109
6.8.2	Unit Alarm and Event Handling	109
6.8.3	User defined events.....	111
6.9	Front Panel Lockout	112
6.10	Limits Settings Lock	113
6.11	Function Generator Use.....	113
6.11.1	FG Introduction.....	113
6.11.2	General FG Description	114
6.11.3	Method of Operation	115
6.11.4	Manual Operation	116
6.11.5	Sine Wave Function	118
6.11.6	Triangular Function.....	119
6.11.7	Rectangular Function	119
6.11.8	Trapezoidal function.....	120
6.11.9	DIN 40839 Function.....	120
6.11.10	Arbitrary Function.....	121
6.11.11	Ramp Function.....	127
6.11.12	UI and IU Table Functions (XY Table).....	128
6.11.13	PV Table Function (Photovoltaics).....	130
6.12	Remote Control of the Function Generator.....	132
7	Remote Control Programming.....	133
7.1	Overview	133
7.2	General Comments	133
7.2.1	Interface Startup Times	133
7.2.2	Linear Network Topologies	133
7.2.3	Browser HTTP Access	133
7.2.4	TCP Network Access	134
7.2.5	General Unit Communication	134
7.2.6	Message timing and command execution time	135
7.3	Communications Protocols Overview	136
7.3.1	Supported Protocols by Interface Module.....	137
7.3.2	Remote Control Characteristics	137
7.3.3	Fragmented messages on serial transmissions.....	138
7.3.4	Connection Timeout.....	138
7.3.5	Effective Programming Resolution	138
7.4	Function Generator Minimum Slope	139
7.5	ModBus Protocol.....	140

7.5.1	Preface	140
7.5.2	General ModBus RTU Information	140
7.5.3	General ModBus TCP Information	140
7.5.4	Format of set values and resolution	140
7.5.5	Translating Set values to Actual values	141
7.6	USB Communication	141
7.6.1	USB driver installation	141
7.6.2	First steps	142
7.7	Other Digital Interface Communication	142
7.8	Register Lists	142
7.9	ModBus RTU Details	144
7.9.1	Control Message (write)	145
7.9.2	Response Message (read)	146
7.9.3	The ModBus Checksum	146
7.9.4	Communication Errors	147
7.9.5	Examples of ModBus RTU messages	148
7.10	ModBus TCP Details	151
7.10.1	Example of ModBus TCP messages	151
7.11	Information on Specific Registers	152
7.11.1	Register 171	152
7.11.2	Register 408	152
7.11.3	Register 411	152
7.11.4	Registers 500-503 (Set values)	152
7.11.5	Register 505 (Device status)	153
7.11.6	Registers 650 - 662 (Master-slave configuration)	153
7.11.7	Registers 850 - 6695 (Function generator)	154
7.11.8	Registers 9000 - 9009 (Adjustment limits)	157
7.11.9	Registers 10007 - 10900	157
7.11.10	Register from 12000 (PV simulation / DIN EN 50530)	157
7.12	SCPI Command Language	160
7.12.1	SCPI Examples	160
7.12.2	SCPI Command Syntax	161
7.12.3	SCPI Errors	163
7.12.4	Standard IEEE Commands	163
7.12.5	Status Register	164
7.12.6	Set Value Commands	167
7.12.7	Measurement Commands	169
7.12.8	Status commands	170
7.12.9	Supervisory Commands	172
7.12.10	Master/Slave Operation Commands	173
7.12.11	Commands for general queries	174
7.12.12	Unit Configuration Commands	174
7.12.13	Interface Module Commands (Excl. Ethernet)	176
7.12.14	Ethernet Interface Commands	177
7.12.15	Function Generator Commands	179
7.12.16	Alarm Management Commands	184
7.12.17	Commands for Extended PV Simulation	186
7.12.18	Application Examples	191
7.13	Profibus & Profinet	201
7.13.1	General	201
7.13.2	Preparation	201
7.13.3	Slot configuration for Profibus	201
7.13.4	Slot configuration for Profinet	202
7.13.5	Cyclic communication via Profibus/Profinet	203

7.13.6	Acyclic communication via Profibus/Profinet	203
7.13.7	Examples for acyclic access	205
7.13.8	Data interpretation	207
7.14	CANopen	208
7.14.1	Preparation	208
7.14.2	User objects (indexes)	208
7.14.3	Translation ADI -> register	208
7.14.4	Specific examples	209
7.14.5	Using the arbitrary generator	209
7.14.6	Error codes	210
7.15	CAN Bus	210
7.15.1	Preparation	210
7.15.2	Introduction	211
7.15.3	Message formats	211
7.15.4	Message examples	216
7.16	EtherCAT	218
7.16.1	Introduction	218
7.16.2	Integrating your unit in TwinCAT	218
7.16.3	Data objects	218
7.16.4	PDOs	219
7.16.5	SDOs	219
7.16.6	Use of the data objects	219
8	Master/Slave (M/S) Operation	220
8.1	Parallel Operation	220
8.1.1	Restrictions	221
8.1.2	DC Output Wiring Parallel Mode	221
8.1.3	Wire Sizing for Share Bus	221
8.1.4	Wiring and set-up of the Digital Master/Slave bus	221
8.1.5	Operating a Master/Slave System	223
8.1.6	Alarms and other problem situations	224
8.2	Series Operation	225
8.3	Battery Charging Operation	225
8.4	Two Quadrant Operation (2QO)	226
8.4.1	2QO Application:	226
8.4.2	Connecting Units to a 2QO Test Systems	226
8.4.3	2QO Operation Unit Settings	227
8.4.4	Restrictions	227
8.4.5	Application example	227
9	Calibration	229
9.1	Preface	229
9.2	Preparation	229
9.3	Calibration Procedure	230
9.3.1	Calibrating Set Values	230
9.3.2	Calibrating Remote Sense	230
9.3.3	Calibrating Measurement Values	231
9.3.4	Save Cal Coefficients and Exit	231
10	CE MARK Declaration of Conformity	232
	Index	233

Table of Tables

Table 3-1: Included Accessories	23
Table 3-2: Available Remote Control Interface Options.....	24
Table 3-3: Available Options.....	26
Table 5-1: Ship Kit Content	59
Table 5-2: DC Load Wire Size Table	68
Table 6-1: USB Memory File Types for Loading.....	80
Table 6-2: USB Memory File Types for saving	80
Table 6-3: Analog Interface Specifications	105
Table 6-4: Alarm Signals	109
Table 6-5: Function Generator Capacities Overview	114
Table 7-1: Interface Modules supported Protocols.....	137
Table 7-2: ModBus RTU Functions	145
Table 7-3: Supported SCPI Command and Parameter formats	162
Table 7-4: SCPI Error Messages	163

Table of Figures

Figure 3-1: DCS Series Block Diagram.....	17
Figure 3-2: DCS Series Ship Kit Content.....	23
Figure 5-2: DCS Series Ship Kit Content.....	59
Figure 5-3: AC Input Mating Connector- 3U Models - (Cable shown not included)	61
Figure 5-4: AC Input Mating Connector 208V – 4U Models – 4 Wire.....	62
Figure 5-5: AC Input Mating Connector 480V – 3U Models - (Cable shown not included)	63
Figure 5-6: AC Input Mating Connector 480V – 4U Models – 4 Wire.....	63
Figure 5-7: AC Input Mating Connector 480V – 4U Models – 5 Wire.....	63
Figure 5-8: DC Terminal Types 1 & 2 for 3U Models	69
Figure 5-9: DC Terminal Types 1 & 2 for 4U Models	69
Figure 5-10: External Voltage Sense Connection – 3U Models	71
Figure 5-11: External Voltage Sense Connection – 4U Models	71
Figure 5-12: Effect of Current Slew Rate Settings on Power Supply Testing.....	75
Figure 6-1: DCS Series Front Panel View	76
Figure 7-1: SCPI Register Model	165

1 Contact Information

AMERICA / CANADA

Adaptive Power Systems
Irvine, USA
Phone: +1(949) 752-8400
Fax: +1 (949) 756-0838
Email: support@adaptivepower.com

EUROPE

Caltest Instruments GmbH.
Kappelrodeck, Germany
Phone: +49 7842 99722-00
Fax: +49 7842 99722-29
Email: support@adaptivepower.com

CHINA

PPST Shanghai Co. Ltd.
Shanghai, China
Phone: +86-21-6763-9223
Fax: +86-21-5763-8240
Email: support@adaptivepower.com

Web: <http://www.adaptivepower.com>

2 Warranty, Service and Safety Information

2.1 General

This document is to be kept in either hardcopy or PDF electronic form near the equipment for future reference and explanation of the operation of the instrument. This document or its electronic equivalent is to be retained and kept with the equipment in case of change of location and/or user.

2.2 Limited Warranty

Adaptive Power Systems, Inc. (APS) warrants each unit to be free from defects in material and workmanship. For the period of three (3) years from the date of shipment to the purchaser, APS will either repair or replace, at its sole discretion, any unit returned to the APS factory in Irvine, California or one of its designated service facilities. It does not cover damage arising from misuse of the unit or attempted field modifications or repairs. This warranty specifically excludes damage to other equipment connected to this unit.

Upon notice from the purchaser within (30) days of shipment of units found to be defective in material or workmanship, APS will pay all shipping charges for the repair or replacement. If notice is received more than thirty (30) days from shipment, all shipping charges shall be paid by the purchaser. Units returned on debit memos will not be accepted and will be returned without repair.

This warranty is exclusive of all other warranties, expressed or implied.

2.3 Service and Spare Parts Limited Warranty

APS warrants repair work to be free from defects in material and workmanship for the period of ninety (90) days from the invoice date. This Service and Spare Parts Limited Warranty applies to replacement parts or to subassemblies only. All shipping and packaging charges are the sole responsibility of the buyer. APS will not accept debit memos for returned power sources or for subassemblies. Debit memos will cause return of power sources or assemblies without repair.

This warranty is exclusive of all other warranties, expressed or implied.

2.4 Equipment Disposal

Disposal of this equipment at the end of its technical or economical life must be done in accordance with local prevailing recycling regulations for electronic waste.

2.5 Safety Information

This chapter contains important information you should read **BEFORE** attempting to install and power-up APS Equipment. The information in this chapter is provided for use by experienced operators. Experienced operators understand the necessity of becoming familiar with, and then observing, life-critical safety and installation issues. Topics in this chapter include:

- Safety Notices
- Warnings
- Cautions
- Preparation for Installation
- Installation Instructions



Make sure to familiarize yourself with the **SAFETY SYMBOLS** shown on the next page. These symbols are used throughout this manual and relate to important safety information and issues affecting the end user or operator.

SAFETY SYMBOLS



Direct current (DC)



Alternating current (AC)



Both direct and alternating current



Three-phase alternating current



Protective Earth (ground) terminal



On (Supply)



Off (Supply)



Fuse



Caution: Refer to this manual before this Product.



Caution, risk of electric shock

2.6 Safety Notices

SAFETY SUMMARY

The following general safety precautions must be observed during all phases of operation, service, and repair of this instrument. Failure to comply with these precautions or with specific warnings elsewhere in this manual violates safety standards of design, manufacture, and intended use of the instrument. Adaptive Power Systems assumes no liability for the customer's failure to comply with these requirements.

GENERAL

This product is a Safety Class 1 instrument (provided with a protective earth terminal). The protective features of this product may be impaired if it is used in a manner not specified in the operation instructions.

ENVIRONMENTAL CONDITIONS

This instrument is intended for indoor use in an installation category I, pollution degree 2 environments. It is designed to operate at a maximum relative humidity of 80% and at altitudes of up to 2000 meters. Refer to the specifications tables for the ac mains voltage requirements and ambient operating temperature range.

BEFORE APPLYING POWER

Verify that the product is set to match the available line voltage.

GROUND THE INSTRUMENT

This product is a Safety Class 1 instrument (provided with a protective earth terminal). To minimize shock hazard, the instrument chassis and cabinet must be connected to an electrical ground. The instrument must be connected to the AC power supply mains through a properly rated three-conductor power cable, with the third wire firmly connected to an electrical ground (safety ground) at the power outlet. Any interruption of the protective (grounding) conductor or disconnection of the protective earth terminal will cause a potential shock hazard that could result in personal injury.

FUSES

Only fuses with the required rated current, voltage, and specified type (normal blow, time delay, etc.) should be used. Do not use repaired Fuses or short circuit the fuse holder. To do so could cause a shock or fire hazard.

DO NOT OPERATE IN AN EXPLOSIVE ATMOSPHERE.

Do not operate the instrument in the presence of flammable gases or fumes.

KEEP AWAY FROM LIVE CIRCUITS.

Operating personnel must not remove instrument covers. Component replacement and internal adjustments must be made by qualified service personnel. Do not replace components with power cable connected. Under certain conditions, dangerous voltages

may exist even with the power cable removed. To avoid injuries, always disconnect power, discharge circuits and remove external voltage sources before touching components.

LETHAL DANGER - HAZARDOUS VOLTAGE



Electrical equipment operation means that some parts can be under hazardous voltage. Therefore all parts under voltage must be covered! This applies to all DCS Series models.

All work on connections must be carried out under zero voltage (output not connected to load) and may only be performed by qualified and informed persons. Improper actions can cause fatal injury as well as serious material damage.



Never touch cables or connectors directly after unplugging from mains supply as the danger of electric shock remains!

Never touch the contacts on the DC output terminal directly after switching off the DC output, because there still can dangerous voltage present, sinking more or less slowly depending on the load! There also can be dangerous potential between negative DC output to PE or positive DC output to PE due to charged X capacitors, which may not discharge.

Always follow these five safety rules when working with electric devices:

1. Disconnect completely
2. Secure against reconnection
3. Verify that the system is dead
4. Carry out earthing and short-circuiting
5. Provide protection from adjacent live parts

DO NOT SERVICE OR ADJUST ALONE.

Do not attempt internal service or adjustment unless another person, capable of rendering first aid and resuscitation, is present.

DO NOT EXCEED INPUT RATINGS.

This instrument may be equipped with a line filter to reduce electromagnetic interference and must be connected to a properly grounded receptacle to minimize electric shock hazard. Operation at line voltages or frequencies in excess of those stated on the data plate may cause leakage currents in excess of 5.0 mA peak.

DO NOT SUBSTITUTE PARTS OR MODIFY INSTRUMENT.

Because of the danger of introducing additional hazards, do not install substitute parts or perform any unauthorized modification to the instrument. Return the instrument to an Adaptive Power Systems Sales and Service Office for service and repair to ensure that safety features are maintained.

Instruments that appear damaged or defective should be made inoperative and secured against unintended operation until they can be repaired by qualified service personnel.

OTHER DO'S AND DONT'S

- Do not insert any object, particularly metallic, through the ventilator slots
- Avoid any use of liquids near the equipment. Protect the unit from wet, damp and condensation.
- Do not connect loads, particularly low resistance, to units under power; sparking may occur which can cause burns as well as damage to the equipment and to the user.
- ESD regulations must be applied when plugging interface cards or modules into the relative slot
- Interface cards or modules may only be attached or removed after the unit is **switched off**. It is not necessary to open the unit.
- Do not connect external power sources with reversed polarity to DC input or outputs! The equipment will be damaged.
- Avoid where possible connecting external power sources to the DC output, and never those that can generate a higher voltage than the nominal voltage of the unit.
- Never insert a network cable which is connected to Ethernet or its components into the master- slave socket on the back of the unit!
- Always configure the various protecting features against overvoltage etc. for sensitive loads to what the target application requires!

2.7 Intended Usage

This equipment is intended to be used only as a variable voltage and current source. Typical application for a power supply is to supply precision controlled DC power to any relevant DC load.

- Claims of any sort due to damage caused by non-intended usage will not be accepted.
- All damage caused by non-intended usage is the sole responsibility of the operator.

3 Product Overview

This chapter provides an overview of the APS DCS Series programmable DC power supplies. It introduces the reader to general operating characteristics of these power supplies.

3.1 General Description

The APS DCS Series DC power supply is designed to provide accurate, stable and clean DC power to a unit under test. The APS DCS Series power supply can be operated from the front panel (manual mode, also referred to as Human Machine Interface or HMI) or using any of the available digital or analog remote control interfaces. Standard interfaces are USB and isolated analog I/O. Other interfaces can be added as options.

These programmable DC power supplies are especially suitable for test systems and industrial controls due to their compact construction in a 19" enclosure (3U or 4U rack height). Apart from basic functions of power supplies, voltage and current set point curves can be generated using the integrated function generator (sine, rectangular, triangular and other curve types). If needed, arbitrary generator curves up to 100 points can be saved to and loaded from an USB memory stick.

Using the optional plug-in digital interface modules, other interfaces such as Profibus, ProfiNet, ModBus TCP, CAN or CANopen can be added easily. These enable the units to be connected to standard industrial buses simply by changing or adding a small interface module. The configuration for each of these, if required at all, is simple.

In addition, the units offer as standard the possibility for parallel connection using a Share bus master/slave mode for constant current sharing plus a genuine master-slave connection. Summing of master and slave units measurements by the master is standard. Operating in this way allows up to 32 units to be combined to a single system with a total power of up to 960 kW.

All models are controlled by microprocessors. This enables an exact and fast measurement and display of setting and read back values.

The performance of the DCS Series DC power supply models are detailed in section 4, "Technical Specifications". Maximum voltage, current and power capability depends on the specific model. This manual covers standard DCS Series models. If your unit has a custom voltage and current range, most of the information in this manual still applies.

3.2 Product Features

The following key characteristics apply to all DCS Series models:

- Fully programmable electronic DC power supply with advanced controller function.
- Fully remote control of all settings and metering read back.
- Dual high accuracy and high-resolution voltage, current and power meters.
- Constant Power Mode AUTO RANGING Voltage and Current output supports both high voltage and low current application requirements with a single model.
- Over voltage, current and over power protection.
- External voltage sense.
- Isolated Analog I/O
- Battery Charging Test Modes
- PV Simulation mode

3.3 Block Diagram

The block diagram illustrates the main components inside the unit and their relationships. There are digital, microprocessor controlled components (Controller, Communication, Front Panel Interface), which can be the target of firmware updates.

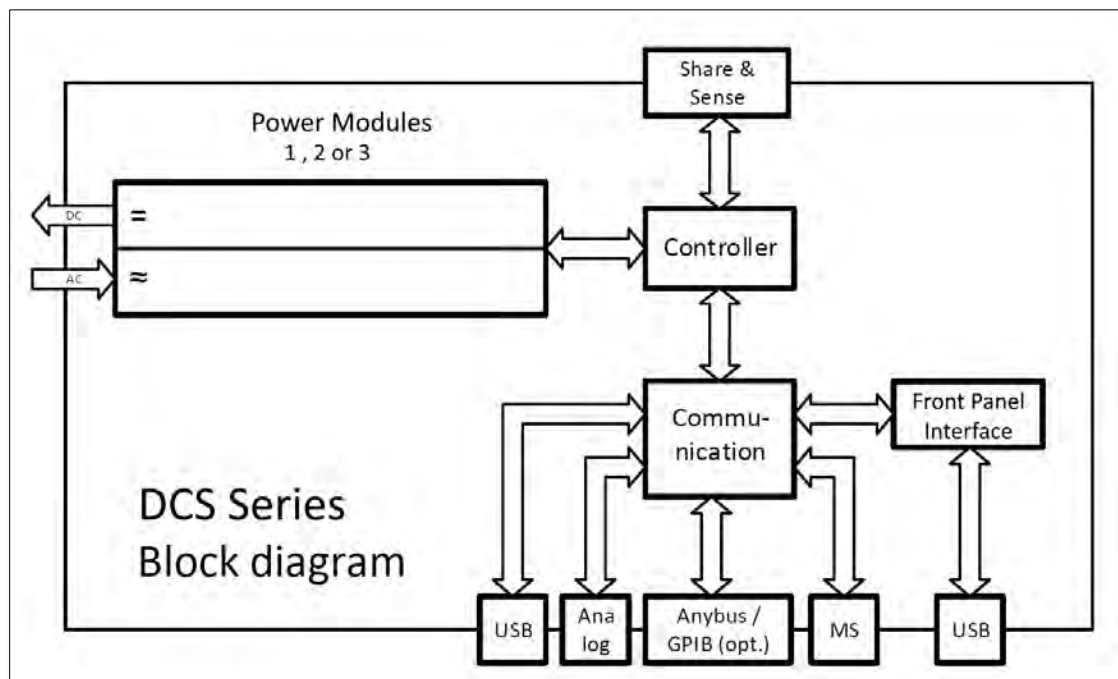

Figure 3-1: DCS Series Block Diagram

3.4 Operating Modes

The DCS Series programmable DC power supplies support the following operating modes:

- Constant Voltage (CV) mode
- Constant Current (CC) mode
- Constant Power (CP) mode
- Internal Resistance (IR) mode

Notes:

- Unloaded operation is not considered a normal operation mode and can thus lead to incorrect measurements. Keep this in mind when calibrating the unit
- The optimal working point of the unit is between 50% and 100% voltage and current
- It is recommended not to operate the unit below 10% of rated voltage and current to make sure technical specifications like ripple and transient times can be met.

3.4.1 Constant Voltage (CV) Mode

In Constant Voltage mode, the DC supply will attempt to maintain precise voltage regulation regardless of the amount of current demanded by the load. Thus, the power supply operates as a voltage source. Once the current demanded by the load reaches the current limit (I_{max}) or power limit (P_{max}) setting value, the power supply will cross over to operate in constant current or constant power mode, whichever condition occurs first. At this point, the voltage will be reduced as needed from the voltage set point to maintain the I_{max} current or P_{max} power level. Once the load impedance increases again, the supply will revert back to constant voltage mode at the set voltage.

While the DC output is switched on and constant voltage mode is active, the condition “CV mode active” will be indicated on the display by the abbreviation **CV** and this message will be passed as a signal to the analog interface. It is also stored as status condition, which can be read as a status message via the digital interface.

Note: When connecting the DC power supply to an active load such as a battery, make sure to use reverse current blocking diode to prevent current from flowing into the DC supply output. This could happen if the battery voltage exceeds the DC supply’s output voltage.

3.4.1.1 Load step transient times

For constant voltage mode (CV), the technical data “Transient time after load step” (see Section 4, Technical Specifications) defines a time that is required by the internal voltage control loop of the unit to settle the output voltage after a load step. Negative load steps, i.e. high load to lower load, will cause the output voltage to overshoot for a short time until compensated by the voltage loop. The same occurs with a positive load step, i.e. low load to high load. There the output collapses briefly. The amplitude of the voltage overshoot or undershoot depends on the power supply model.

This behavior is illustrated in the figures.

Example for neg. load step: the DC output will rise above the adjusted value for a short time. t = transient time to settle the output voltage.

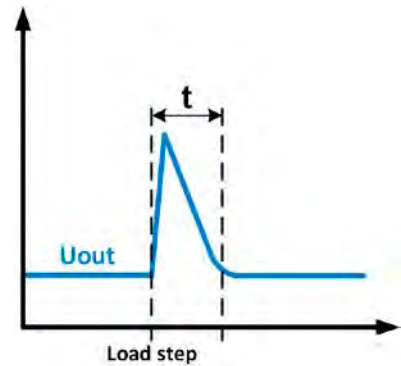

Example for pos. load step: the DC output will collapse below the adjusted value for a short time. t = transient time to settle the output voltage.

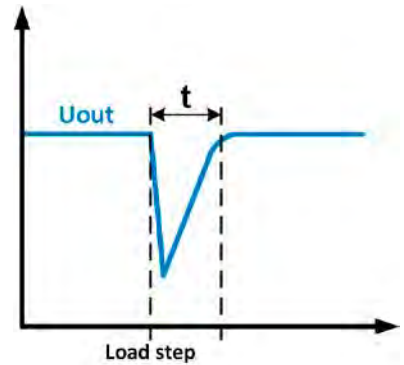

3.4.2 Constant Current (CC) Mode

Constant Current mode is also known as current limiting or current regulation mode. The DC output current is held constant by the power supply, once the output current to the load reaches the set current limit. Then the power supply automatically switches to CC mode. The current flowing from the power supply is determined by the output voltage and the load's resistance. As long as the output current is lower than the current limit set point, the power supply will be either in constant voltage or constant power mode. If, however, the power consumption reaches the maximum power set value P_{max} , the unit will switch to power limiting and sets the output current according to $I_{MAX} = P_{set} / V_{in}$, even if the maximum current value is higher. The current set point, as determined by the user, is always an upper limit value only.

While the DC output is switched on and constant current mode is active, the condition "CC mode active" will be indicated on the graphic display by the abbreviation **CC** and this message will be passed as a signal to the analog interface. It is also stored as a status condition, which can be read as a status message via the digital interface.

3.4.3 Constant Power (CP) Mode

Constant Power mode, also known as power limiting or power regulation, keeps the DC output power of a power supply constant if the current flowing to the load in relation to the output voltage and the resistance of load reaches the adjusted value according to $P = U \cdot I$ resp. $P = U^2 / R$. The power limiting then regulates the output current according to $I = \sqrt{P / R}$, where R is the load's resistance.

Power limiting operates according an auto-range method such that at lower output voltages, higher current is available and vice versa in order to maintain a constant output power level within the range P_N (see diagram to the right).

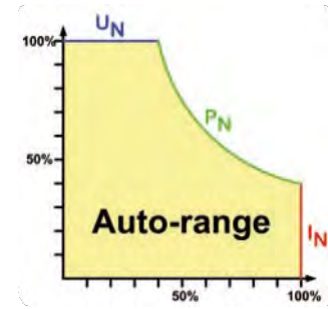

While the DC output is switched on and constant power mode is active, the condition “CP mode active” will be shown on the display by the abbreviation **CP**. It is also stored as a status condition, which can be read as a status message via digital interface.

Note: When using remote sensing, the power supply can deliver a higher voltage on the DC output than adjusted, which results in additional power and may also cause the unit to enter power limit condition without explicitly showing “CP” in the display.

3.4.4 Internal Resistance (IR) Mode

In Internal Resistance mode, the DC supply will not zero load regulate but rather operate the set voltage point minus a voltage drop determined by the load current and the programmed internal resistance setting. Thus, the DC supply will simulate having an internal impedance that causes the output voltage to drop as the load current increases.

$$V_{out} = V_{set} - (I_{out} * R_i)$$

IR mode is useful for simulating the effects of battery discharge over time by adjusting the value of R_i as a function of time.

This mode will work in constant current mode as well as in constant power mode, but here the output voltage will differ even more from the adjusted voltage, because then constant voltage is not active.

The adjustable resistance range is generally defined between 0 and $30 * U_{NOM} / I_{NOM}$ of the particular model used. The voltage setting is dependent on the resistance set value and the output current is obtained by calculation of the microcontroller and thus will be slower the other controllers inside the control circuit. Clarification:

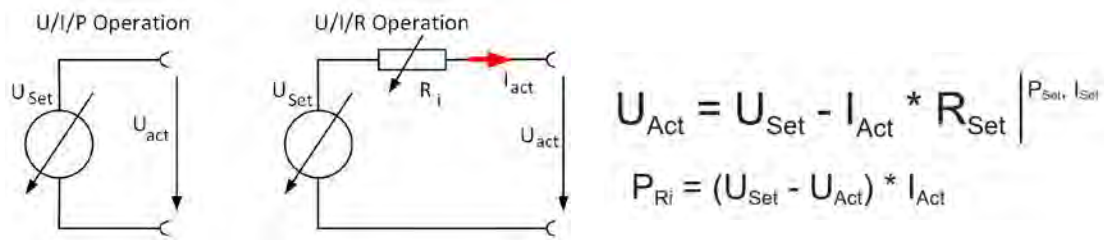

Note: With resistance mode active, the function generator will be unavailable and the actual power value provided by the unit does not include the simulated power dissipation of R_i .

3.5 Alarm Conditions

Note: This section only gives an overview of available unit alarms. What to do in case your unit indicates an alarm condition is described in section 6.6, “Alarms and Monitoring” on page 109.

In general, all alarm conditions are communicated visually (text + message in the display), audibly (if activated) and as a readable status and alarm count via the digital interface. In addition, the alarms OT and OVP are reported as signals on the analog interface. For later inquiries, an alarm counter can be read from the display or via the digital interface.

3.5.1 Power Fail

Power Fail (PF) indicates an alarm condition, which may have several causes:

1. AC input voltage too low (mains under voltage or mains failure)
2. Defect in the input circuit (PFC)

As soon as a power fail occurs, the unit will cease to supply power and switch off the DC output. In case the power fail was due to an under voltage condition that disappears again, the alarm will vanish from the display and no alarm acknowledgement is required to re-enable the DC output.

Note: Switching off the unit with the mains switch cannot be distinguished from a mains blackout and thus the unit will signal a PF alarm every time the device is switched off. This event can be ignored.

Note: The condition of the DC output after a PF alarm during normal operation can be set up. See section 6.4.3, “MENU System Overview” on page 81.

3.5.2 Over Temperature Protection

An over temperature alarm condition (OT) can occur as a result of excessive temperature inside the unit and temporarily causes it to stop supplying power. After cooling down, the unit will automatically resume supplying power. No alarm acknowledgment is required.

3.5.3 Over Voltage Protection

An overvoltage alarm (OVP) will switch off the DC output and can occur if:

1. The power supply itself, as a voltage source, generates an output voltage higher than set for the overvoltage alarm threshold (OVP, 0...110% U_{Nom}) or the connected load somehow returns voltage higher than this threshold.
2. The OVP threshold has been set too close to the output voltage. If the unit is in CC mode and if it then experiences a negative load step, it will make the voltage rise quickly, resulting in a voltage overshoot for a short period, which can trigger the OVP alarm.

This function serves to warn the user of the power supply audibly or visually that the unit probably has generated an excessive voltage, which could damage the connected load.



- The unit is **not** fitted with any protection from external over voltages
- The transition between operation modes CC -> CV can generate voltage overshoots

3.5.4 Over Current Protection

An overcurrent alarm (OCP) will switch off the DC output and can occur if:

1. The output current at the DC output reaches the set OCP limit.

This function serves to protect the connected load so that it is not over loaded and possibly damaged due to excessive current.

3.5.5 Over Power Protection

An Over Power Protection alarm (OPP) will switch off the DC output and can occur if:

1. The output power (product of the output voltage and output current) at the DC output reaches the set OPP limit.

This function serves to protect the connected load so that it is not over loaded and possibly damaged due to excessive power consumption.

3.6 Accessories Included

The following accessories are included with each DCS Series DC power supply. If one or more of these is missing upon incoming inspection of the product, please contact Adaptive Power Systems customer service.

Item	Description	Quantity
A	Share Bus plug	1
B	Remote sensing plug	1
C	1.8 m USB cable	1
D	Set of DC terminal covers	1 Set
E	Share/Sense terminal cover (only for models from 750 V)	1
F	USB stick with documentation and software	1
G	AC connector plug (clamp type)	1
H	Strain relieves (pre-mounted)	1 Set

Table 3-1: Included Accessories

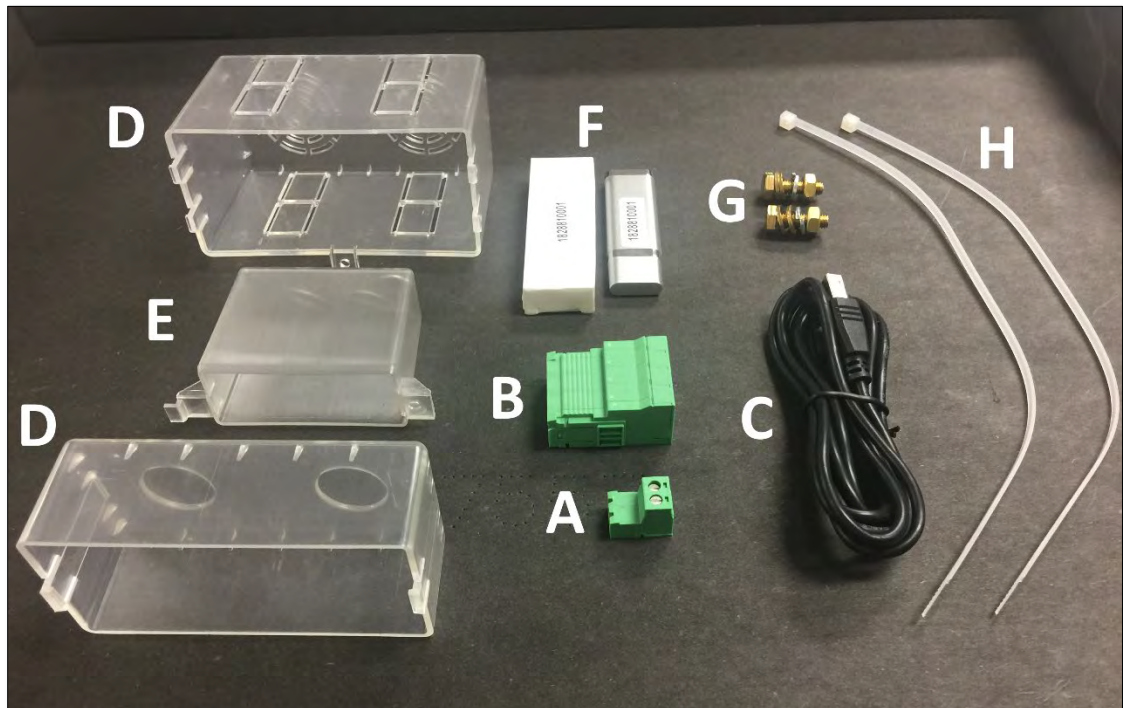

Figure 3-2: DCS Series Ship Kit Content

3.7 Remote Control Interfaces

3.7.1 USB Interface (standard)

The USB port on the rear panel of the unit is provided for remote control and for firmware updates. The included USB cable can be used to connect the unit to a PC (USB 2.0 or 3.0). The driver is delivered with the unit and installs as a virtual COM port. Details about remote control can be found in section 7 “Remote Control Programming”.

The unit can be addressed via this port using either the international standard ModBus RTU protocol or by SCPI language. The unit recognizes the message protocol used automatically.

If remote control is in use, the USB port has no priority over either the interface module (see below) or the analog interface and should therefore only be used in place of any of these. However, monitoring is always available.

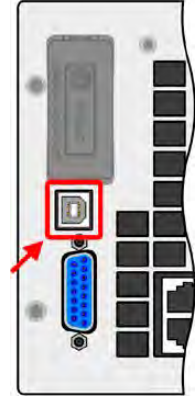

3.7.2 Ethernet Interface (standard on 4U models)

On 4U rack height models, the Ethernet (LAN) Interface is standard.

3.7.3 Interface Module Slot

One additional interface can be installed in the interface module slot on the rear panel. These removable interfaces are easy to exchange in order to change interface types. Details about the interface modules and the programming of the unit using those interfaces can be found in section 7.

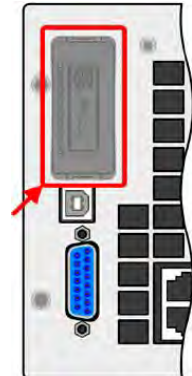

OPTIONS	DESCRIPTION	OPTIONS	DESCRIPTION
OPT-232	RS232 Serial Interface	OPT-ETH2P	Ethernet/IP 2 Port Interface
OPT-PBUS	Profibus DPV1-Interface	OPT-PNET1P	Profinet-IO 1 Port Interface
OPT-CANO	CANopen Interface	OPT-PNET2P	Profinet-IO 2 Port Interface
OPT-DNET	DeviceNet Interface	OPT-CAN	CAN Interface
OPT-MBUS1P	Modbus-TCP 1 Port Interface	OPT-ECT	EtherCAT Interface
OPT-MBUS2P	Modbus-TCP 2 Port Interface	OPT-3IF	3 Way Interface Analog/USB/GPIB available on 3U height models only
OPT-ETH1P	Ethernet/IP 1 Port Interface	Opt-RCT	Redundant Contactors

Table 3-2: Available Remote Control Interface Options

These modules are installed by the user and can be retrofitted without problem. A firmware update of the unit may be necessary in order to recognize and support certain modules.

If remote control is in operation the interface module has no priority over either the USB port or the analog interface and can, therefore, only be used alternately to these. However, monitoring is always available.

 **Note:** Switch off unit before adding or removing modules!

3.7.4 Analog Interface

This 15 pole Sub-D socket on the rear panel of the unit is provided for remote control of the unit via analog or digital signals. If remote control is in operation this analog interface can only be used alternately to the digital interface. Also, monitoring is always available.

The input voltage range of the set values and the output voltage range of the monitor values, as well as reference voltage levels can be configured in the **SETTINGS** menu of the unit between as 0-5 V or 0-10 V, in each case for 0-100%.

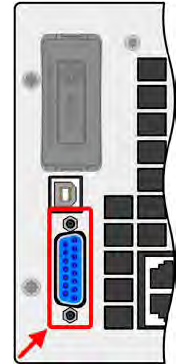

3.7.5 Share Connections

The two-pole WAGO style socket (labelled “Share”) on the rear panel of the unit is provided for connection to same sockets on compatible APS power supplies series to achieve a balanced load current distribution during parallel connection. The same socket is also used to connect the power supply to compatible APS electronic loads, in order to build a two-quadrant operation setup. Following power supply and electronic load series are compatible:

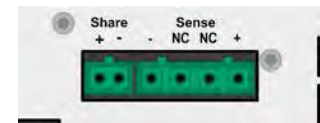

- APS DCS Series
- APS 6RL Series

3.7.6 Voltage Sense Connections (Remote Sense)

In order to compensate for voltage drops along the DC cables to the load, the Sense input can be connected to the load. The maximum possible voltage drop compensation is provided in the technical specifications.

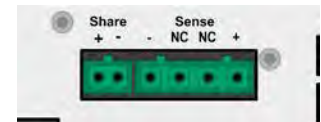

Note: In order to ensure safety and to comply with international directives, insulation of high voltage models, i. e. such with a nominal voltage of 500 V or higher, must be ensured by using only the two outer pins of the 4-pole terminal. The inner two pins, marked with NC, must remain unconnected at all times.

3.7.7 Master-Slave Bus

A Master/Slave bus port is provided on the rear of the unit. This port is comprised of two RJ45 sockets and enables multiple identical units to be connected via a digital bus (RS485) to create a master-slave system. Connections are made using standard CAT5 network cables. These can theoretically have a length of up to 1200 m, but it is recommended to keep these connections as short as possible.



3.7.8 GPIB Interface Option

An optional GPIB connector is available as option –GPIB on **3U height models only** and replaces the modular interface slot of standard power source models. The unit with the GPIB option then offers a three-way interface using GPIB, USB and analog. The connection to a PC or other GPIB port is done with standard GPIB cables, which can have straight or 90° angle connectors.

Note: When using cable with 90° connectors, the USB port will be inaccessible.

Note: The modular digital optional interface are not supported on DCS models configured with the –GPIB interface option.

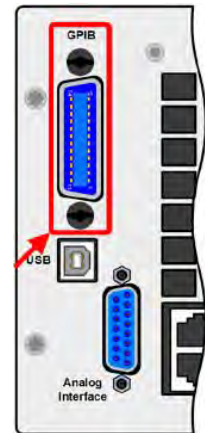

3.8 Other Options

The following options are available for these units.

Option	Description
CABINET 19"-rack	Racks in various configurations up to 42U as parallel systems are available, or mixed with electronic load units to create test systems. Further information in our product catalogue, on our website or upon request
HS High-Speed Ramping	Increased output voltage dynamics through reduced output capacity. NOTE: other output values, as well as ripple also increase. This is a permanent hardware feature, which cannot be switched off.
GPIB interface	Replaces the standard slot for pluggable interface modules by a rigidly installed GPIB port. Available on 3U height models only. The unit will keep the USB and analog interfaces. Via the GPIB port only SCPI commands are supported.
DCS SLAVE Additional slave units	Slave units are intended to extend the power of specific standard models. They do not feature an HMI and are intended to only run being controlled by the master. The slave units can be ordered by model number and retrofitted on location. A patch cable for master-slave bus connection of the additional slave is included.

Table 3-3: Available Options

4 Technical Specifications

Technical specifications shown here apply at an ambient temperature of 25° C ± 5°.

4.1 5kW 3U Models – 208Vac Input (-2)

5 kW	Model				
	DCS80-170-2	DCS200-70-2	DCS360-40-2	DCS500-30-2	DSC750-20-2
AC Input					
Voltage (L-L), Frequency	208V AC, ±10%, 45 - 65 Hz				
Connection	2ph, PE	2ph, PE	2ph, PE	2ph, PE	2ph, PE
Fusing (internal)	2x T32 A	2x T32 A	2x T32 A	2x T32 A	2x T32 A
Leak current	< 3.5 mA	< 3.5 mA	< 3.5 mA	< 3.5 mA	< 3.5 mA
Power factor	> 0.99	> 0.99	> 0.99	> 0.99	> 0.99
DC Output					
Max. output voltage U_{Max}	80 V	200 V	360 V	500 V	750 V
Max. output current I_{Max}	170 A	70 A	40 A	30 A	20 A
Max. output power P_{Max}	5 kW	5 kW	5 kW	5 kW	5 kW
Overvoltage protection range	0...88 V	0...220 V	0...396 V	0...550 V	0...825 V
Overcurrent protection range	0...187 A	0...77 A	0...44 A	0...33 A	0...22 A
Overpower protection range	0...5.5 kW	0...5.5 kW	0...5.5 kW	0...5.5 kW	0...5.5 kW
Temp.coefficient Δ/K	Voltage / current: 100 ppm				
Output capacitance (approx.)	8500 μ F	2500 μ F	400 μ F	250 μ F	100 μ F
Voltage regulation					
Adjustment range	0...81.6 V	0...204 V	0...367.2 V	0...510 V	0...765 V
Accuracy ⁽¹⁾ (at 23±5°C / 73±9°F)	< 0.1% U_{Max}	< 0.1% U_{Max}	< 0.1% U_{Max}	< 0.1% U_{Max}	< 0.1% U_{Max}
Line regulation at ±10% ΔU_{AC}	< 0.02% U_{Max}	< 0.02% U_{Max}	< 0.02% U_{Max}	< 0.02% U_{Max}	< 0.02% U_{Max}
Load regulation at 0...100% load	< 0.05% U_{Max}	< 0.05% U_{Max}	< 0.05% U_{Max}	< 0.05% U_{Max}	< 0.05% U_{Max}
Rise time 10...90% ΔU	Max. 30 ms	Max. 30 ms	Max. 30 ms	Max. 30 ms	Max. 30 ms
Transient time after load step	< 1.5 ms	< 1.5 ms	< 1.5 ms	< 1.5 ms	< 1.5 ms
Display: Accuracy ⁽⁴⁾	≤ 0.2% U_{Max}	≤ 0.2% U_{Max}	≤ 0.2% U_{Max}	≤ 0.2% U_{Max}	≤ 0.2% U_{Max}
Ripple ⁽²⁾	< 200 mV _{pp} < 16 mV _{RMS}	< 300 mV _{pp} < 40 mV _{RMS}	< 550 mV _{pp} < 65 mV _{RMS}	< 350 mV _{pp} < 70 mV _{RMS}	< 800 mV _{pp} < 200 mV
Remote sensing compensation	Max. 5% U_{Max}	Max. 5% U_{Max}	Max. 5% U_{Max}	Max. 5% U_{Max}	Max. 5% U_{Max}
Fall time at no load after switching DC output off	Down from 100% to <60 V: less than 10 s				
Current regulation					
Adjustment range	0...173.4 A	0...71.4 A	0...40.8 A	0...30.6 A	0...20.4 A
Accuracy ⁽¹⁾ (at 23±5°C / 73±9°F)	< 0.2% I_{Max}	< 0.2% I_{Max}	< 0.2% I_{Max}	< 0.2% I_{Max}	< 0.2% I_{Max}
Line regulation at ±10% ΔU_{AC}	< 0.05% I_{Max}	< 0.05% I_{Max}	< 0.05% I_{Max}	< 0.05% I_{Max}	< 0.05% I_{Max}
Load regulation at 0...100% ΔU_{OUT}	< 0.15% I_{Max}	< 0.15% I_{Max}	< 0.15% I_{Max}	< 0.15% I_{Max}	< 0.15% I_{Max}
Ripple ⁽²⁾	< 80 mA _{RMS}	< 22 mA _{RMS}	< 5.2 mA _{RMS}	< 16 mA _{RMS}	< 16 mA _{RMS}
Display: Accuracy ⁽⁴⁾	≤ 0.2% I_{Max}	≤ 0.2% I_{Max}	≤ 0.2% I_{Max}	≤ 0.2% I_{Max}	≤ 0.2% I_{Max}
Power regulation					
Adjustment range	0...5.1 kW	0...5.1 kW	0...5.1 kW	0...5.1 kW	0...5.1 kW
Accuracy ⁽¹⁾ (at 23±5°C / 73±9°F)	< 1% P_{Max}	< 1% P_{Max}	< 1% P_{Max}	< 1% P_{Max}	< 1% P_{Max}
Line regulation at ±10% ΔU_{AC}	< 0.05% P_{Max}	< 0.05% P_{Max}	< 0.05% P_{Max}	< 0.05% P_{Max}	< 0.05% P_{Max}
Load reg. at 10-90% ΔU_{OUT} * ΔI_{OUT}	< 0.75% P_{Max}	< 0.75% P_{Max}	< 0.75% P_{Max}	< 0.75% P_{Max}	< 0.75% P_{Max}
Display: Accuracy ⁽⁴⁾	≤ 0.8% P_{Max}	≤ 0.8% P_{Max}	≤ 0.8% P_{Max}	≤ 0.8% P_{Max}	≤ 0.8% P_{Max}
Efficiency ⁽³⁾	~ 93%	~ 95%	~ 95%	~ 95,5%	~ 94%

5 kW	<i>Model</i>				
	<i>DCS80-170-2</i>	<i>DCS200-70-2</i>	<i>DCS360-40-2</i>	<i>DCS500-30-2</i>	<i>DSC750-20-2</i>
Internal resistance regulation					
Adjustment range	0...14 Ω	0...85 Ω	0...270 Ω	0...500 Ω	0...1125 Ω
Accuracy ⁽¹⁾	≤1% of max. resistance ± 0.3% of rated current				
Analog interface ⁽²⁾					
Set value inputs	U, I, P, R				
Actual value output	U, I				
Control signals	DC on/off, remote control on/off, resistance mode on/off				
Status signals	CV, OVP, OT				
Galvanic isolation to the unit	Max. 1500 V DC				
Sample rate of inputs & outputs	500 Hz				
Insulation					
Allowed float (potential shift) on the DC output:					
Negative terminal to PE Max.	±400 V DC	±400 V DC	±400 V DC	±725 V DC	±725 V DC
Positive terminal to PE Max.	±400 V DC	±600 V DC	±600 V DC	±1000 V DC	±1000 V DC
AC input <-> PE	2.5 kV DC				
AC input <-> DC output	2.5 kV DC				
Miscellaneous					
Cooling	Temperature controlled fans, front inlet, rear exhaust				
Ambient temperature	0...50°C (32...122°F)				
Storage temperature	-20...70°C (-4...158°F)				
Humidity	< 80%, not condensing				
Standards	IEC 61010:2010 EMC TÜV approved acc. IEC 61000-6-2:2005 and IEC 61000-6-3:2006 Class B				
Overvoltage category	2				
Protection class	1				
Pollution degree	2				
Operational altitude	< 2000 m (1.242 mi)				
Digital interfaces					
Featured	1x USB-B for communication, 1x USB-A for functions, 1x GPIB (optional on 3U models only)				
Slot (standard version)	optional: CANopen, Profibus, Profinet, RS232, CAN, Ethernet, ModBus TCP				
Galvanic isolation from unit	Max. 1500 V DC				
Terminals					
Rear side	Share Bus, DC output, AC input, remote sensing, analog interface, USB-B, master-slave bus, interface module slot				
Front side	USB-A				
Dimensions					
Enclosure (WxHxD)	19" x 3U x 682 mm (26.8")				
Total (WxHxD)	483 x 133 x 787 mm (19" x 5.2 x 31")				
Weight	~ 17 kg/37.5 lbs.	~ 17 kg/37.5 lbs.	~ 17 kg/37.5 lbs.	~ 17 kg/37.5 lbs.	~ 17 kg/37.5 lbs.

Notes:

1. Related to the nominal values, the accuracy defines the maximum deviation between an adjusted values and the true (actual) value. For example, a 80 V model has min. 0.1% voltage accuracy, that is 80 mV. When adjusting the voltage to 5 V, the actual value is allowed to differ max. 80 mV, which means it might be between 4.92 V and 5.08 V.
2. RMS value: LF 0...300 kHz, PP value: HF 0...20MHz
3. Typical value at 100% output voltage and 100% power
4. The display error adds to the error of the related actual value on the DC output

4.2 10kW 3U Models -208Vac Input (-2)

10 kW	<i>Model</i>				
	<i>DCS80-340-2</i>	<i>DCS200-140-2</i>	<i>DCS360-80-2</i>	<i>DCS500-60-2</i>	<i>DCS750-40-2</i>
AC Input					
Voltage (L-L)	208V AC, ±10%, 45 - 65 Hz				
Connection	3ph,PE	3ph,PE	3ph,PE	3ph,PE	3ph,PE
Fusing (internal)	4x T32 A	4x T32 A	4x T32 A	4x T32 A	4x T32 A
Leak current	< 3.5 mA	< 3.5 mA	< 3.5 mA	< 3.5 mA	< 3.5 mA
Power factor	> 0.99	> 0.99	> 0.99	> 0.99	> 0.99
DC Output					
Max. output voltage U _{Max}	80 V	200 V	360 V	500 V	750 V
Max. output current I _{Max}	340 A	140 A	80 A	60 A	40 A
Max. output power P _{Max}	10 kW	10 kW	10 kW	10 kW	10 kW
Oversvoltage protection range	0...88 V	0...220 V	0...396 V	0...550 V	0...825 V
Overcurrent protection range	0...374 A	0...154 A	0...88 A	0...66 A	0...44 A
Overpower protection range	0...11 kW	0...11 kW	0...11 kW	0...11 kW	0...11 kW
Temp. coefficient Δ/K	Voltage / current: 100 ppm				
Output capacitance (approx.)	16900 μF	5040 μF	800 μF	500 μF	210 μF
Voltage regulation					
Adjustment range	0...81.6 V	0...204 V	0...367.2 V	0...510 V	0...785 V
Accuracy ⁽¹⁾ (at 23±5°C / 73±9°F)	< 0.1% U _{Max}	< 0.1% U _{Max}	< 0.1% U _{Max}	< 0.1% U _{Max}	< 0.1% U _{Max}
Line regulation at ±10% ΔU _{AC}	< 0.02% U _{Max}	< 0.02% U _{Max}	< 0.02% U _{Max}	< 0.02% U _{Max}	< 0.02% U _{Max}
Load regulation at 0...100% load	< 0.05% U _{Max}	< 0.05% U _{Max}	< 0.05% U _{Max}	< 0.05% U _{Max}	< 0.05% U _{Max}
Rise time 10...90% ΔU	Max. 30 ms	Max. 30 ms	Max. 30 ms	Max. 30 ms	Max. 30 ms
Transient time after load step	< 1.5 ms	< 1.5 ms	< 1.5 ms	< 1.5 ms	< 1.5 ms
Display: Accuracy ⁽⁴⁾	≤ 0.2% U _{Max}	≤ 0.2% U _{Max}	≤ 0.2% U _{Max}	0...510 V	0...785 V
Ripple ⁽²⁾	< 320 mVpp < 25 mV	< 300 mVpp < 40 mV	< 550 mVpp < 65 mV	< 350 mVpp < 70 mV	< 800 mVpp < 200 mV
Remote sensing compensation	Max. 5% U _{Max}	Max. 5% U _{Max}	Max. 5% U _{Max}	Max. 5% U _{Max}	Max. 5% U _{Max}
Fall time at no load after switching DC output off	Down from 100% to <60 V: less than 10 s				
Current regulation					
Adjustment range	0...346.8 A	0...142.8 A	0...81.6 A	0...61.2 A	0...40.8 A
Accuracy ⁽¹⁾ (at 23±5°C / 73±9°F)	< 0.2% I _{Max}	< 0.2% I _{Max}	< 0.2% I _{Max}	< 0.2% I _{Max}	< 0.2% I _{Max}
Line regulation at ±10% ΔU _{AC}	< 0.05% I _{Max}	< 0.05% I _{Max}	< 0.05% I _{Max}	< 0.05% I _{Max}	< 0.05% I _{Max}
Load regulation at 0...100% ΔU _{OUT}	< 0.15% I _{Max}	< 0.15% I _{Max}	< 0.15% I _{Max}	< 0.15% I _{Max}	< 0.15% I _{Max}
Ripple ⁽²⁾	< 160 mARMS	< 44 mARMS	< 35 mARMS	< 32 mARMS	< 32 mARMS
Display: Accuracy ⁽⁴⁾	≤ 0.2% I _{Max}	≤ 0.2% I _{Max}	≤ 0.2% I _{Max}	≤ 0.2% I _{Max}	≤ 0.2% I _{Max}
Power regulation					
Adjustment range	0...10.2 kW	0...10.2 kW	0...10.2 kW	0...10.2 kW	0...10.2 kW
Accuracy ⁽¹⁾ (at 23±5°C / 73±9°F)	< 1% P _{Max}	< 1% P _{Max}	< 1.2% P _{Max}	< 1% P _{Max}	< 1% P _{Max}
Line regulation at ±10% ΔU _{AC}	< 0.05% P _{Max}	< 0.05% P _{Max}	< 0.05% P _{Max}	< 0.05% P _{Max}	< 0.05% P _{Max}
Load reg. at 10-90% ΔU _{OUT} * ΔI _{OUT}	< 0.75% P _{Max}	< 0.75% P _{Max}	< 0.75% P _{Max}	< 0.75% P _{Max}	< 0.75% P _{Max}
Display: Accuracy ⁽⁴⁾	≤ 0.8% P _{Max}	≤ 0.85% P _{Max}	≤ 0.8% P _{Max}	0...10.2 kW	0...10.2 kW
Efficiency ⁽³⁾	~ 93%	~ 95%	~ 93%	~ 95%	~ 94%

10 kW	<i>Model</i>				
	<i>DCS80-340-2</i>	<i>DCS200-140-2</i>	<i>DCS360-80-2</i>	<i>DCS500-60-2</i>	<i>DCS750-40-2</i>
Internal resistance regulation					
Adjustment range	0...7 Ω	0...42 Ω	0...135 Ω	0...250 Ω	0...562 Ω
Accuracy ¹	≤1% of max. resistance ± 0.3% of rated current				
Analog interface ²					
Set value inputs	U, I, P, R				
Actual value output	U, I				
Control signals	DC on/off, remote control on/off, resistance mode on/off				
Status signals	CV, OVP, OT				
Galvanic isolation to the unit	Max. 1500 V DC				
Sample rate of inputs & outputs	500 Hz				
Insulation					
Allowed float (potential shift) on the DC output:					
Negative terminal to PE Max.	±400 V DC	±725 V DC	±725 V DC	±1500 V DC	±1500 V DC
Positive terminal to PE Max.	±400 V DC	±1000 V DC	±1000 V DC	±1800 V DC	±1800 V DC
AC input <-> PE	2.5 kV DC				
AC input <-> DC output	2.5 kV DC				
Miscellaneous					
Cooling	Temperature controlled fans, front inlet, rear exhaust				
Ambient temperature	0..50°C (32...122°F)				
Storage temperature	-20...70°C (-4...158°F)				
Humidity	< 80%, not condensing				
Standards	IEC 61010:2010 EMC TÜV approved acc. IEC 61000-6-2:2005 and IEC 61000-6-3:2006 Class B				
Overvoltage category	2				
Protection class	1				
Pollution degree	2				
Operational altitude	< 2000 m (1.242 mi)				
Digital interfaces					
Featured	1x USB-B for communication, 1x USB-A for functions, 1x GPIB (optional on 3U height models only)				
Slot (standard version)	optional: CANopen, Profibus, Profinet, RS232, CAN, Ethernet, ModBus TCP				
Galvanic isolation from unit	Max. 1500 V DC				
Terminals					
Rear side	Share Bus, DC output, AC input, remote sensing, analog interface, USB-B, master-slave bus, interface module slot				
Front side	USB-A				
Dimensions					
Enclosure (WxHxD)	19" x 3U x 682 mm (26.8")				
Total (WxHxD)	483 x 133 x 787 mm (19" x 5.2 x 31")				
Weight	~ 24 kg/52.9 lbs.	~ 24 kg/52.9 lbs.	~ 24 kg/52.9 lbs.	~ 24 kg/52.9 lbs.	~ 24 kg/52.9 lbs.

Notes:

1. Related to the nominal values, the accuracy defines the maximum deviation between an adjusted values and the true (actual) value. For example, a 80 V model has min. 0.1% voltage accuracy, that is 80 mV. When adjusting the voltage to 5 V, the actual value is allowed to differ max. 80 mV, which means it might be between 4.92 V and 5.08 V.
2. RMS value: LF 0...300 kHz, PP value: HF 0...20MHz
3. Typical value at 100% output voltage and 100% power
4. The display error adds to the error of the related actual value on the DC output

4.3 15kW 3U Models -208Vac Input (-2)

15 kW	Model				
	DCS80-510-2	DCS200-210-2	DCS360-120-2	DCS500-90-2	DCS750-60-2
AC Input					
Voltage (L-L)	208V AC, ±10%, 45 - 65 Hz				
Connection	3ph,PE	3ph,PE	3ph,PE	3ph,PE	3ph,PE
Fusing (internal)	4x T32 A	4x T32 A	4x T32 A	4x T32 A	4x T32 A
Leak current	< 3.5 mA	< 3.5 mA	< 3.5 mA	< 3.5 mA	< 3.5 mA
Power factor	> 0.99	> 0.99	> 0.99	> 0.99	> 0.99
DC Output					
Max. output voltage U _{Max}	80 V	200 V	360 V	500 V	750 V
Max. output current I _{Max}	510 A	210 A	120 A	90 A	60 A
Max. output power P _{Max}	15 kW	15 kW	15 kW	15 kW	15 kW
Oversvoltage protection range	0...88 V	0...220 V	0...396 V	0...550 V	0...825 V
Overcurrent protection range	0...561 A	0...231 A	0...132 A	0...99 A	0...66 A
Overpower protection range	0...16.5 kW	0...16.5 kW	0...16.5 kW	0...16.5 kW	0...16.5 kW
Temp. coefficient Δ/K	Voltage / current: 100 ppm				
Output capacitance (approx.)	25380 μF	7560 μF	1200 μF	760 μF	310 μF
Voltage regulation					
Adjustment range	0...81.6 V	0...204 V	0...367.2 V	0...510 V	0...765 V
Accuracy ¹ (at 23±5°C / 73±9°F)	< 0.1% U _{Max}	< 0.1% U _{Max}	< 0.1% U _{Max}	< 0.1% U _{Max}	< 0.1% U _{Max}
Line regulation at ±10% ΔU _{AC}	< 0.02% U _{Max}	< 0.02% U _{Max}	< 0.02% U _{Max}	< 0.02% U _{Max}	< 0.02% U _{Max}
Load regulation at 0...100% load	< 0.05% U _{Max}	< 0.05% U _{Max}	< 0.05% U _{Max}	< 0.05% U _{Max}	< 0.05% U _{Max}
Rise time 10...90% ΔU	Max. 30 ms	Max. 30 ms	Max. 30 ms	Max. 30 ms	Max. 30 ms
Transient time after load step	< 1.5 ms	< 1.5 ms	< 1.5 ms	< 1.5 ms	< 1.5 ms
Display: Accuracy ⁴	≤ 0.2% U _{Max}	≤ 0.2% U _{Max}	≤ 0.2% U _{Max}	≤ 0.2% U _{Max}	≤ 0.2% U _{Max}
Ripple ²	< 320 mV _{pp} < 25 mV	< 300 mV _{pp} < 40 mV	< 550 mV _{pp} < 65 mV	< 350 mV _{pp} < 70 mV	< 800 mV _{pp} < 200 mV
Remote sensing compensation	Max. 5% U _{Max}	Max. 5% U _{Max}	Max. 5% U _{Max}	Max. 5% U _{Max}	Max. 5% U _{Max}
Fall time at no load after switching DC output off	Down from 100% to <60 V: less than 10 s				
Current regulation					
Adjustment range	0...520.2 A	0...214.2 A	0...122.4 A	0...91.8 A	0...61.2 A
Accuracy ¹ (at 23±5°C / 73±9°F)	< 0.2% I _{Max}	< 0.2% I _{Max}	< 0.2% I _{Max}	< 0.2% I _{Max}	< 0.2% I _{Max}
Line regulation at ±10% ΔU _{AC}	< 0.05% I _{Max}	< 0.05% I _{Max}	< 0.05% I _{Max}	< 0.05% I _{Max}	< 0.05% I _{Max}
Load regulation at 0...100% ΔU _{OUT}	< 0.15% I _{Max}	< 0.15% I _{Max}	< 0.15% I _{Max}	< 0.15% I _{Max}	< 0.15% I _{Max}
Ripple ²	< 240 mA _{RMS}	< 66 mA _{RMS}	< 50 mA _{RMS}	< 48 mA _{RMS}	< 48 mA _{RMS}
Display: Accuracy ⁴	≤ 0.2% I _{Max}	≤ 0.2% I _{Max}	≤ 0.2% I _{Max}	≤ 0.2% I _{Max}	≤ 0.2% I _{Max}
Power regulation					
Adjustment range	0...15.3 kW	0...15.3 kW	0...15.3 kW	0...15.3 kW	0...15.3 kW
Accuracy ¹ (at 23±5°C / 73±9°F)	< 1% P _{Max}	< 1% P _{Max}	< 1% P _{Max}	< 1% P _{Max}	< 1% P _{Max}
Line regulation at ±10% ΔU _{AC}	< 0.05% P _{Max}	< 0.05% P _{Max}	< 0.05% P _{Max}	< 0.05% P _{Max}	< 0.05% P _{Max}
Load reg. at 10-90% ΔU _{OUT} * ΔI _{OUT}	< 0.75% P _{Max}	< 0.75% P _{Max}	< 0.75% P _{Max}	< 0.75% P _{Max}	< 0.75% P _{Max}
Display: Accuracy ⁴	≤ 0.8% P _{Max}	≤ 0.8% P _{Max}	≤ 0.85% P _{Max}	≤ 0.85% P _{Max}	≤ 0.85% P _{Max}
Efficiency ³	~ 93%	~ 95%	~ 94%	~ 95%	~ 94%

15 kW	<i>Model</i>				
	<i>DCS80-510-2</i>	<i>DCS200-210-2</i>	<i>DCS360-120-2</i>	<i>DCS500-90-2</i>	<i>DCS750-60-2</i>
Internal resistance regulation					
Adjustment range	0...5 Ω	0...28 Ω	0...90 Ω	0...166 Ω	0...375 Ω
Accuracy ¹	≤1% of max. resistance ± 0.3% of rated current				
Analog interface ²					
Set value inputs	U, I, P, R				
Actual value output	U, I				
Control signals	DC on/off, remote control on/off, resistance mode on/off				
Status signals	CV, OVP, OT				
Galvanic isolation to the unit	Max. 1500 V DC				
Sample rate of inputs & outputs	500 Hz				
Insulation					
Allowed float (potential shift) on the DC output:					
Negative terminal to PE Max.	±400 V DC	±725 V DC	±725 V DC	±1500 V DC	±1500 V DC
Positive terminal to PE Max.	±400 V DC	±1000 V DC	±1000 V DC	±1800 V DC	±1800 V DC
AC input <-> PE	2.5 kV DC				
AC input <-> DC output	2.5 kV DC				
Miscellaneous					
Cooling	Temperature controlled fans, front inlet, rear exhaust				
Ambient temperature	0..50°C (32...122°F)				
Storage temperature	-20...70°C (-4...158°F)				
Humidity	< 80%, not condensing				
Standards	IEC 61010:2010 EMC TÜV approved acc. IEC 61000-6-2:2005 and IEC 61000-6-3:2006 Class B				
Overvoltage category	2				
Protection class	1				
Pollution degree	2				
Operational altitude	< 2000 m (1.242 mi)				
Digital interfaces					
Featured	1x USB-B for communication, 1x USB-A for functions, 1x GPIB (optional on 3U height models only)				
Slot (standard version)	optional: CANopen, Profibus, Profinet, RS232, CAN, Ethernet, ModBus TCP				
Galvanic isolation from unit	Max. 1500 V DC				
Terminals					
Rear side	Share Bus, DC output, AC input, remote sensing, analog interface, USB-B, master-slave bus, interface module slot				
Front side	USB-A				
Dimensions					
Enclosure (WxHxD)	19" x 3U x 682 mm (26.8")				
Total (WxHxD)	483 x 133 x 787mm (19" x 5.2 x 31")				
Weight	~ 30 kg/66.1 lbs.	~ 30 kg/66.1 lbs.	~ 30 kg/66.1 lbs.	~ 30 kg/66.1 lbs.	~ 30 kg/66.1 lbs.

Notes:

1. Related to the nominal values, the accuracy defines the maximum deviation between an adjusted values and the true (actual) value. For example, a 80 V model has min. 0.1% voltage accuracy, that is 80 mV. When adjusting the voltage to 5 V, the actual value is allowed to differ max. 80 mV, which means it might be between 4.92 V and 5.08 V.
2. RMS value: LF 0...300 kHz, PP value: HF 0...20MHz
3. Typical value at 100% output voltage and 100% power
4. The display error adds to the error of the related actual value on the DC output

15 kW	<i>Model</i>			
	<i>DCS1000-40-2</i>	<i>DCS1500-30-2</i>		
AC Input				
Voltage (L-L)	208V AC, ±10%, 45 - 65 Hz			
Connection	3ph,PE	3ph,PE		
Fusing (internal)	4x T32 A	4x T32 A		
Leak current	< 3.5 mA	< 3.5 mA		
Power factor	> 0.99	> 0.99		
DC Output				
Max. output voltage U _{Max}	1000 V	1500 V		
Max. output current I _{Max}	40 A	30 A		
Max. output power P _{Max}	15 kW	15 kW		
Overvoltage protection range	0...1100 V	0...1650 V		
Overcurrent protection range	0...44 A	0...33 A		
Overpower protection range	0...16.5 kW	0...16.5 kW		
Temp. coefficient Δ/K	Voltage / current: 100 ppm			
Output capacitance (approx.)	133 μF	84 μF		
Voltage regulation				
Adjustment range	0...1020 V	0...1560 V		
Accuracy ⁽¹⁾ (at 23±5°C / 73±9°F)	< 0.1% U _{Max}	< 0.1% U _{Max}		
Line regulation at ±10% ΔU _{AC}	< 0.02% U _{Max}	< 0.02% U _{Max}		
Load regulation at 0...100% load	< 0.05% U _{Max}	< 0.05% U _{Max}		
Rise time 10...90% ΔU	Max. 30 ms	Max. 30 ms		
Transient time after load step	< 1.5 ms	< 1.5 ms		
Display: Accuracy ⁽⁴⁾	≤ 0.2% U _{Max}	≤ 0.2% U _{Max}		
Ripple ⁽²⁾	< 2000 mV _{PP} < 300 mV	< 2400 mV _{PP} < 400 mV		
Remote sensing compensation	Max. 5% U _{Max}	Max. 5% U _{Max}		
Fall time at no load after switching DC output off	Down from 100% to <60 V: less than 10 s			
Current regulation				
Adjustment range	0...40.8 A	0...30.6 A		
Accuracy ⁽¹⁾ (at 23±5°C / 73±9°F)	< 0.2% I _{Max}	< 0.2% I _{Max}		
Line regulation at ±10% ΔU _{AC}	< 0.05% I _{Max}	< 0.05% I _{Max}		
Load regulation at 0...100% ΔU _{OUT}	< 0.15% I _{Max}	< 0.15% I _{Max}		
Ripple ⁽²⁾	< 36 mA _{RMS}	< 26 mA _{RMS}		
Display: Accuracy ⁽⁴⁾	≤ 0.2% I _{Max}	≤ 0.2% I _{Max}		
Power regulation				
Adjustment range	0...15.3 kW	0...15.3 kW		
Accuracy ⁽¹⁾ (at 23±5°C / 73±9°F)	< 1% P _{Max}	< 1% P _{Max}		
Line regulation at ±10% ΔU _{AC}	< 0.05% P _{Max}	< 0.05% P _{Max}		
Load reg. at 10-90% ΔU _{OUT} * ΔI _{OUT}	< 0.75% P _{Max}	< 0.75% P _{Max}		
Display: Accuracy ⁽⁴⁾	≤ 0.85% P _{Max}	≤ 0.85% P _{Max}		
Efficiency ⁽³⁾	~ 94%	~ 95%		

15 kW		<i>Model</i>			
		<i>DCS1000-40-2</i>	<i>DCS1500-30-2</i>		
Internal resistance regulation					
Adjustment range	0...1300 Ω	0...1500 Ω			
Accuracy ¹	≤1% of max. resistance ± 0.3% of rated current				
Analog interface ²					
Set value inputs	U, I, P, R				
Actual value output	U, I				
Control signals	DC on/off, remote control on/off, resistance mode on/off				
Status signals	CV, OVP, OT				
Galvanic isolation to the unit	Max. 1500 V DC				
Sample rate of inputs & outputs	500 Hz				
Insulation					
Allowed float (potential shift) on the DC output:					
Negative terminal to PE Max.	±1500 V DC	±1500 V DC			
Positive terminal to PE Max.	±1800 V DC	±1800 V DC			
AC input <-> PE	2.5 kV DC				
AC input <-> DC output	2.5 kV DC				
Miscellaneous					
Cooling	Temperature controlled fans, front inlet, rear exhaust				
Ambient temperature	0..50°C (32...122°F)				
Storage temperature	-20...70°C (-4...158°F)				
Humidity	< 80%, not condensing				
Standards	IEC 61010:2010 EMC TÜV approved acc. IEC 61000-6-2:2005 and IEC 61000-6-3:2006 Class B				
Overvoltage category	2				
Protection class	1				
Pollution degree	2				
Operational altitude	< 2000 m (1.242 mi)				
Digital interfaces					
Featured	1x USB-B for communication, 1x USB-A for functions, 1x GPIB (optional on 3U height models only)				
Slot (standard version)	optional: CANopen, Profibus, Profinet, RS232, CAN, Ethernet, ModBus TCP				
Galvanic isolation from unit	Max. 1500 V DC				
Terminals					
Rear side	Share Bus, DC output, AC input, remote sensing, analog interface, USB-B, master-slave bus, interface module slot				
Front side	USB-A				
Dimensions					
Enclosure (WxHxD)	19" x 3U x 682 mm (26.8")				
Total (WxHxD)	483 x 133 x 787mm (19" x 5.2 x 31")				
Weight	~ 30 kg/66.1 lbs.	~ 30 kg/66.1 lbs.			

Notes:

1. Related to the nominal values, the accuracy defines the maximum deviation between an adjusted values and the true (actual) value. For example, a 80 V model has min. 0.1% voltage accuracy, that is 80 mV. When adjusting the voltage to 5 V, the actual value is allowed to differ max. 80 mV, which means it might be between 4.92 V and 5.08 V.
2. RMS value: LF 0...300 kHz, PP value: HF 0...20MHz
3. Typical value at 100% output voltage and 100% power
4. The display error adds to the error of the related actual value on the DC output

4.1 15kW 4U Models – 208Vac Input (-2)

The 208 Vac AC Input models, designated on the type label as “-2”, are derivations from the standard models, intended to be sold on the US or Japan market or places where 208 V three-phase supply is typical. The differences compared to the standard models are in the AC supply and DC power rating, as listed in the tables below. The remaining specifications are listed in section 4.5, “30kW Models – 380V~480Vac Input (-4)” on page 48.

30 kW	<i>Model</i>			
	<i>DCS80-1000-4</i>	<i>DCS200-420-4</i>	<i>DCS360-240-4</i>	<i>DCS500-180-4</i>
AC Input				
Voltage (L-L)	187...228 V AC, 45 - 65 Hz			
Connection	3ph,PE	3ph,PE	3ph,PE	3ph,PE
DC Output				
Max. output power P _{Max}	15 kW	15 kW	15 kW	15 kW
Overpower protection range	0...16.5 kW	0...16.5 kW	0...16.5 kW	0...16.5 kW
Power regulation				
Adjustment range	0...15.3 kW	0...15.3 kW	0...15.3 kW	0...15.3 kW

30 kW	<i>Model</i>			
	<i>DCS750-120-4</i>	<i>DCS1000-80-4</i>	<i>DCS1500-60-4</i>	<i>DCS2000-40-4</i>
AC Input				
Voltage (L-L)	187...228 V AC, 45 - 65 Hz			
Connection	3ph,PE	3ph,PE	3ph,PE	3ph,PE
DC Output				
Max. output power P _{Max}	15 kW	15 kW	15 kW	15 kW
Overpower protection range	0...16.5 kW	0...16.5 kW	0...16.5 kW	0...16.5 kW
Power regulation				
Adjustment range	0...15.3 kW	0...15.3 kW	0...15.3 kW	0...15.3 kW

4.2 5kW 3U HP Models – 208V~480Vac Input (-4)

HP version models provide improved specifications compared to non HP versions and supports a universal wide AC input range. Note that max. output power with US region 208Vac input is only 60% of full rated power.

5kW MODEL	DCS80-170HP ³	DCS200-70HP	DCS360-40HP	DCS500-30HP	DCS750-20HP
Voltage Range	0~80 V	0~200 V	0~360 V	0~500 V	0~750 V
Current Range	0...170 A	0...70 A	0...40 A	0...30 A	0...20 A
CP V-I Range	29.4V@170A ~ 80V@62.5A	71.4V@70A ~ 200V@25A	125V@40A ~ 360V@13.9A	166.7V@30A ~ 500V@10A	250V@20A ~ 750V@6.7A
Voltage Ripple	<100 mVpp <10 mVrms	<300 mVpp <40 mVrms	<320mVpp <55mVrms	<350mVpp <70mVrms	<800mVpp <200mVrms
Current Ripple	<80 mArms	<22 mArms	<18 mArms	<16 mArms	<16 mArms
Insulation -DC to PE	±600 Vdc	±1000 Vdc	±1000 Vdc	±1500 Vdc	±1500 Vdc
Insulation +DC to PE	+600 Vdc	+1000 Vdc	+1000 Vdc	+2000 Vdc	+2000 Vdc
Power Range ⁴	0~5000 W	0~5000 W	0~5000 W	0~5000 W	0~5000 W
Resistance Range	0.016~26 Ω	0.1~160 Ω	0.3~520 Ω	0.6~1000 Ω	1.2~2200 Ω
Output Capacitance	7790 μF	2520 μF	393 μF	180 μF	180 μF
Efficiency	94.5%	94.5%	95.5%	95.5%	95.5%
Weight	18kg/39.7lbs	18kg/39.7lbs	18kg/39.7lbs	18kg/39.7lbs	18kg/39.7lbs

4.3 5kW 3U Models – 380V~480Vac Input (-4)

5 kW	Model				
	DCS80-170-4	DCS200-70-4	DCS360-40-4	DCS500-30-4	DSC750-20-4
AC Input					
Voltage (L-L), Frequency	342...528 V AC, 45 - 65 Hz				
Connection	2ph, PE	2ph, PE	2ph, PE	2ph, PE	2ph, PE
Fusing (internal)	2x T16 A	2x T16 A	2x T16 A	2x T16 A	2x T16 A
Leak current	< 3.5 mA	< 3.5 mA	< 3.5 mA	< 3.5 mA	< 3.5 mA
Power factor	> 0.99	> 0.99	> 0.99	> 0.99	> 0.99
DC Output					
Max. output voltage U_{Max}	80 V	200 V	360 V	500 V	750 V
Max. output current I_{Max}	170 A	70 A	40 A	30 A	20 A
Max. output power P_{Max}	5 kW	5 kW	5 kW	5 kW	5 kW
Overvoltage protection range	0...88 V	0...220 V	0...396 V	0...550 V	0...825 V
Overcurrent protection range	0...187 A	0...77 A	0...44 A	0...33 A	0...22 A
Overpower protection range	0...5.5 kW	0...5.5 kW	0...5.5 kW	0...5.5 kW	0...5.5 kW
Temp.coefficient Δ/K	Voltage / current: 100 ppm				
Output capacitance (approx.)	8500 μF	2500 μF	400 μF	250 μF	100 μF
Voltage regulation					
Adjustment range	0...81.6 V	0...204 V	0...367.2 V	0...510 V	0...765 V
Accuracy ⁽¹⁾ (at 23 \pm 5°C / 73 \pm 9°F)	< 0.1% U_{Max}	< 0.1% U_{Max}	< 0.1% U_{Max}	< 0.1% U_{Max}	< 0.1% U_{Max}
Line regulation at $\pm 10\% \Delta U_{AC}$	< 0.02% U_{Max}	< 0.02% U_{Max}	< 0.02% U_{Max}	< 0.02% U_{Max}	< 0.02% U_{Max}
Load regulation at 0...100% load	< 0.05% U_{Max}	< 0.05% U_{Max}	< 0.05% U_{Max}	< 0.05% U_{Max}	< 0.05% U_{Max}
Rise time 10...90% ΔU	Max. 30 ms	Max. 30 ms	Max. 30 ms	Max. 30 ms	Max. 30 ms
Transient time after load step	< 1.5 ms	< 1.5 ms	< 1.5 ms	< 1.5 ms	< 1.5 ms
Display: Accuracy ⁽⁴⁾	$\leq 0.2\% U_{Max}$	$\leq 0.2\% U_{Max}$	$\leq 0.2\% U_{Max}$	$\leq 0.2\% U_{Max}$	$\leq 0.2\% U_{Max}$
Ripple ⁽²⁾	< 200 mV _{PP} < 16 mV _{RMS}	< 300 mV _{PP} < 40 mV _{RMS}	< 550 mV _{PP} < 65 mV _{RMS}	< 350 mV _{PP} < 70 mV _{RMS}	< 800 mV _{PP} < 200 mV
Remote sensing compensation	Max. 5% U_{Max}	Max. 5% U_{Max}	Max. 5% U_{Max}	Max. 5% U_{Max}	Max. 5% U_{Max}
Fall time at no load after switching DC output off	Down from 100% to <60 V: less than 10 s				
Current regulation					
Adjustment range	0...173.4 A	0...71.4 A	0...40.8 A	0...30.6 A	0...20.4 A
Accuracy ⁽¹⁾ (at 23 \pm 5°C / 73 \pm 9°F)	< 0.2% I_{Max}	< 0.2% I_{Max}	< 0.2% I_{Max}	< 0.2% I_{Max}	< 0.2% I_{Max}
Line regulation at $\pm 10\% \Delta U_{AC}$	< 0.05% I_{Max}	< 0.05% I_{Max}	< 0.05% I_{Max}	< 0.05% I_{Max}	< 0.05% I_{Max}
Load regulation at 0...100% ΔU_{OUT}	< 0.15% I_{Max}	< 0.15% I_{Max}	< 0.15% I_{Max}	< 0.15% I_{Max}	< 0.15% I_{Max}
Ripple ⁽²⁾	< 80 mA _{RMS}	< 22 mA _{RMS}	< 5.2 mA _{RMS}	< 16 mA _{RMS}	< 16 mA _{RMS}
Display: Accuracy ⁽⁴⁾	$\leq 0.2\% I_{Max}$	$\leq 0.2\% I_{Max}$	$\leq 0.2\% I_{Max}$	$\leq 0.2\% I_{Max}$	$\leq 0.2\% I_{Max}$
Power regulation					
Adjustment range	0...5.1 kW	0...5.1 kW	0...5.1 kW	0...5.1 kW	0...5.1 kW
Accuracy ⁽¹⁾ (at 23 \pm 5°C / 73 \pm 9°F)	< 1% P_{Max}	< 1% P_{Max}	< 1% P_{Max}	< 1% P_{Max}	< 1% P_{Max}
Line regulation at $\pm 10\% \Delta U_{AC}$	< 0.05% P_{Max}	< 0.05% P_{Max}	< 0.05% P_{Max}	< 0.05% P_{Max}	< 0.05% P_{Max}
Load reg. at 10-90% ΔU_{OUT} * ΔI_{OUT}	< 0.75% P_{Max}	< 0.75% P_{Max}	< 0.75% P_{Max}	< 0.75% P_{Max}	< 0.75% P_{Max}
Display: Accuracy ⁽⁴⁾	$\leq 0.8\% P_{Max}$	$\leq 0.8\% P_{Max}$	$\leq 0.8\% P_{Max}$	$\leq 0.8\% P_{Max}$	$\leq 0.8\% P_{Max}$
Efficiency ⁽³⁾	~ 93%	~ 95%	~ 95%	~ 95,5%	~ 94%

5 kW	<i>Model</i>				
	<i>DCS80-170-4</i>	<i>DCS200-70-4</i>	<i>DCS360-40-4</i>	<i>DCS500-30-4</i>	<i>DSC750-20-4</i>
Internal resistance regulation					
Adjustment range	0...14 Ω	0...85 Ω	0...270 Ω	0...500 Ω	0...1125 Ω
Accuracy ⁽¹⁾	≤1% of max. resistance ± 0.3% of rated current				
Analog interface ⁽²⁾					
Set value inputs	U, I, P, R				
Actual value output	U, I				
Control signals	DC on/off, remote control on/off, resistance mode on/off				
Status signals	CV, OVP, OT				
Galvanic isolation to the unit	Max. 1500 V DC				
Sample rate of inputs & outputs	500 Hz				
Insulation					
Allowed float (potential shift) on the DC output:					
Negative terminal to PE Max.	±400 V DC	±400 V DC	±400 V DC	±725 V DC	±725 V DC
Positive terminal to PE Max.	±400 V DC	±600 V DC	±600 V DC	±1000 V DC	±1000 V DC
AC input <-> PE	2.5 kV DC				
AC input <-> DC output	2.5 kV DC				
Miscellaneous					
Cooling	Temperature controlled fans, front inlet, rear exhaust				
Ambient temperature	0...50°C (32...122°F)				
Storage temperature	-20...70°C (-4...158°F)				
Humidity	< 80%, not condensing				
Standards	IEC 61010:2010 EMC TÜV approved acc. IEC 61000-6-2:2005 and IEC 61000-6-3:2006 Class B				
Overvoltage category	2				
Protection class	1				
Pollution degree	2				
Operational altitude	< 2000 m (1.242 mi)				
Digital interfaces					
Featured	1x USB-B for communication, 1x USB-A for functions, 1x GPIB (optional on 3U height models only)				
Slot (standard version)	optional: CANopen, Profibus, Profinet, RS232, CAN, Ethernet, ModBus TCP				
Galvanic isolation from unit	Max. 1500 V DC				
Terminals					
Rear side	Share Bus, DC output, AC input, remote sensing, analog interface, USB-B, master-slave bus, interface module slot				
Front side	USB-A				
Dimensions					
Enclosure (WxHxD)	19" x 3U x 670 mm (26.4")				
Total (WxHxD)	483 x 133 x 774 mm (19" x 5.2x 30.5")				
Weight	~ 18 kg/39.7 lbs.	~ 18 kg/39.7 lbs.	~ 18 kg/39.7 lbs.	~ 18 kg/39.7 lbs.	~ 18 kg/39.7 lbs.

Notes:

1. Related to the nominal values, the accuracy defines the maximum deviation between an adjusted values and the true (actual) value. For example, a 80 V model has min. 0.1% voltage accuracy, that is 80 mV. When adjusting the voltage to 5 V, the actual value is allowed to differ max. 80 mV, which means it might be between 4.92 V and 5.08 V.
2. RMS value: LF 0...300 kHz, PP value: HF 0...20MHz
3. Typical value at 100% output voltage and 100% power
4. The display error adds to the error of the related actual value on the DC output

4.4 10kW 3U HP Models – 208V~480Vac Input (-4)

HP version models provide improved specifications compared to non HP versions and supports a universal wide AC input range. Note that max. output power with US region 208Vac input is only 60% of full rated power.

10kW MODEL	DCS80-340HP ³	DCS200-140HP	DCS360-80HP	DCS500-60HP
Voltage Range	0~80 V	0~200 V	0~360 V	0~500 V
Current Range	0...340 A	0...140 A	0~80 A	0~60 A
CP V-I Range	29.4V@340A ~ 80V@125A	71.4V@140A ~ 200V@50A	125V@80A ~ 360V@27.8A	166.7V@60A ~ 500V@20A
Voltage Ripple	<100mVpp <10mVrm	<300mVpp <40mVrms	<320mVpp <55mVrms	<350mVpp <70mVrms
Current Ripple	<160 mArms	<44 mArms	<35mArms	<32mArms
Insulation -DC to PE	±600 Vdc	±1000 Vdc	±1000 Vdc	±1500 Vdc
Insulation +DC to PE	+600 Vdc	+1000 Vdc	+1000 Vdc	+2000 Vdc
Power Range ⁴	0~10000 W	0~10000 W	0~10000 W	0~10000 W
Resistance Range	0.008~13 Ω	0.05~80 Ω	0.15~260 Ω	0.3~500 Ω
Output Capacitance	15980 μF	5040 μF	786 μF	360 μF
Efficiency	94.5%	94.5%	95.5%	95.5%
Weight	25kg/55.1lbs	25kg/55.1lbs	25kg/55.1lbs	25kg/55.1lbs

10kW MODEL	DCS750-40HP	DCS1000-30HP	DCS1500-20HP
Voltage Range	0~750 V	0~1000 V	0~1500 V
Current Range	0~40 A	0~30 A	0~20 A
CP V-I Range	250V@40A ~ 750V@13.3A	333.3V@30A ~ 1000V@10A	500V@20A ~ 1500V@6.7A
Voltage Ripple	<800mVpp <200mVrms	<1000mVpp <200mVrms	<2000mVpp <400mVrms
Current Ripple	<32mArms	<22mArms	<22mArms
Insulation -DC to PE	±1500 Vdc	±1500 Vdc	±1500 Vdc
Insulation +DC to PE	+2000 Vdc	+2000 Vdc	+2000 Vdc
Power Range ⁴	0~10000 W	0~10000 W	0~10000 W
Resistance Range	0.6~1100 Ω	1.2~2200 Ω	2.6~4500 Ω
Output Capacitance	360 μF	90 μF	90 μF
Efficiency	95.5%	95.5%	95.5%
Weight	25kg/55.1lbs	25kg/55.1lbs	25kg/55.1lbs

4.5 10kW 3U Models – 380V~480Vac Input (-4)

10 kW	<i>Model</i>				
	<i>DCS80-340-4</i>	<i>DCS200-140-4</i>	<i>DCS360-80-4</i>	<i>DCS500-60-4</i>	<i>DCS750-40-4</i>
AC Input					
Voltage (L-L)	342...528 V AC, 45 - 65 Hz				
Connection	3ph,PE	3ph,PE	3ph,PE	3ph,PE	3ph,PE
Fusing (internal)	4x T16 A	4x T16 A	4x T16 A	4x T16 A	4x T16 A
Leak current	< 3.5 mA	< 3.5 mA	< 3.5 mA	< 3.5 mA	< 3.5 mA
Power factor	> 0.99	> 0.99	> 0.99	> 0.99	> 0.99
DC Output					
Max. output voltage U _{Max}	80 V	200 V	360 V	500 V	750 V
Max. output current I _{Max}	340 A	140 A	80 A	60 A	40 A
Max. output power P _{Max}	10 kW	10 kW	10 kW	10 kW	10 kW
Oversvoltage protection range	0...88 V	0...220 V	0...396 V	0...550 V	0...825 V
Overcurrent protection range	0...374 A	0...154 A	0...88 A	0...66 A	0...44 A
Overpower protection range	0...11 kW	0...11 kW	0...11 kW	0...11 kW	0...11 kW
Temp. coefficient Δ/K	Voltage / current: 100 ppm				
Output capacitance (approx.)	16900 μF	5040 μF	800 μF	500 μF	210 μF
Voltage regulation					
Adjustment range	0...81.6 V	0...204 V	0...367.2 V	0...510 V	0...785 V
Accuracy ⁽¹⁾ (at 23±5°C / 73±9°F)	< 0.1% U _{Max}	< 0.1% U _{Max}	< 0.1% U _{Max}	< 0.1% U _{Max}	< 0.1% U _{Max}
Line regulation at ±10% ΔU _{AC}	< 0.02% U _{Max}	< 0.02% U _{Max}	< 0.02% U _{Max}	< 0.02% U _{Max}	< 0.02% U _{Max}
Load regulation at 0...100% load	< 0.05% U _{Max}	< 0.05% U _{Max}	< 0.05% U _{Max}	< 0.05% U _{Max}	< 0.05% U _{Max}
Rise time 10...90% ΔU	Max. 30 ms	Max. 30 ms	Max. 30 ms	Max. 30 ms	Max. 30 ms
Transient time after load step	< 1.5 ms	< 1.5 ms	< 1.5 ms	< 1.5 ms	< 1.5 ms
Display: Accuracy ⁽⁴⁾	≤ 0.2% U _{Max}	≤ 0.2% U _{Max}	≤ 0.2% U _{Max}	0...510 V	0...785 V
Ripple ⁽²⁾	< 320 mVpp < 25 mV	< 300 mVpp < 40 mV	< 550 mVpp < 65 mV	< 350 mVpp < 70 mV	< 800 mVpp < 200 mV
Remote sensing compensation	Max. 5% U _{Max}	Max. 5% U _{Max}	Max. 5% U _{Max}	Max. 5% U _{Max}	Max. 5% U _{Max}
Fall time at no load after switching DC output off	Down from 100% to <60 V: less than 10 s				
Current regulation					
Adjustment range	0...346.8 A	0...142.8 A	0...81.6 A	0...61.2 A	0...40.8 A
Accuracy ⁽¹⁾ (at 23±5°C / 73±9°F)	< 0.2% I _{Max}	< 0.2% I _{Max}	< 0.2% I _{Max}	< 0.2% I _{Max}	< 0.2% I _{Max}
Line regulation at ±10% ΔU _{AC}	< 0.05% I _{Max}	< 0.05% I _{Max}	< 0.05% I _{Max}	< 0.05% I _{Max}	< 0.05% I _{Max}
Load regulation at 0...100% ΔU _{OUT}	< 0.15% I _{Max}	< 0.15% I _{Max}	< 0.15% I _{Max}	< 0.15% I _{Max}	< 0.15% I _{Max}
Ripple ⁽²⁾	< 160 mARMS	< 44 mARMS	< 35 mARMS	< 32 mARMS	< 32 mARMS
Display: Accuracy ⁽⁴⁾	≤ 0.2% I _{Max}	≤ 0.2% I _{Max}	≤ 0.2% I _{Max}	≤ 0.2% I _{Max}	≤ 0.2% I _{Max}
Power regulation					
Adjustment range	0...10.2 kW	0...10.2 kW	0...10.2 kW	0...10.2 kW	0...10.2 kW
Accuracy ⁽¹⁾ (at 23±5°C / 73±9°F)	< 1% P _{Max}	< 1% P _{Max}	< 1.2% P _{Max}	< 1% P _{Max}	< 1% P _{Max}
Line regulation at ±10% ΔU _{AC}	< 0.05% P _{Max}	< 0.05% P _{Max}	< 0.05% P _{Max}	< 0.05% P _{Max}	< 0.05% P _{Max}
Load reg. at 10-90% ΔU _{OUT} * ΔI _{OUT}	< 0.75% P _{Max}	< 0.75% P _{Max}	< 0.75% P _{Max}	< 0.75% P _{Max}	< 0.75% P _{Max}
Display: Accuracy ⁽⁴⁾	≤ 0.8% P _{Max}	≤ 0.85% P _{Max}	≤ 0.8% P _{Max}	0...10.2 kW	0...10.2 kW
Efficiency ⁽³⁾	~ 93%	~ 95%	~ 93%	~ 95%	~ 94%

10 kW	<i>Model</i>				
	<i>DCS80-340-4</i>	<i>DCS200-140-4</i>	<i>DCS360-80-4</i>	<i>DCS500-60-4</i>	<i>DCS750-40-4</i>
Internal resistance regulation					
Adjustment range	0...7 Ω	0...42 Ω	0...135 Ω	0...250 Ω	0...562 Ω
Accuracy ¹	≤1% of max. resistance ± 0.3% of rated current				
Analog interface ²					
Set value inputs	U, I, P, R				
Actual value output	U, I				
Control signals	DC on/off, remote control on/off, resistance mode on/off				
Status signals	CV, OVP, OT				
Galvanic isolation to the unit	Max. 1500 V DC				
Sample rate of inputs & outputs	500 Hz				
Insulation					
Allowed float (potential shift) on the DC output:					
Negative terminal to PE Max.	±400 V DC	±725 V DC	±725 V DC	±1500 V DC	±1500 V DC
Positive terminal to PE Max.	±400 V DC	±1000 V DC	±1000 V DC	±1800 V DC	±1800 V DC
AC input <-> PE	2.5 kV DC				
AC input <-> DC output	2.5 kV DC				
Miscellaneous					
Cooling	Temperature controlled fans, front inlet, rear exhaust				
Ambient temperature	0..50°C (32...122°F)				
Storage temperature	-20...70°C (-4...158°F)				
Humidity	< 80%, not condensing				
Standards	IEC 61010:2010 EMC TÜV approved acc. IEC 61000-6-2:2005 and IEC 61000-6-3:2006 Class B				
Overvoltage category	2				
Protection class	1				
Pollution degree	2				
Operational altitude	< 2000 m (1.242 mi)				
Digital interfaces					
Featured	1x USB-B for communication, 1x USB-A for functions, 1x GPIB (optional on 3U height models only)				
Slot (standard version)	optional: CANopen, Profibus, Profinet, RS232, CAN, Ethernet, ModBus TCP				
Galvanic isolation from unit	Max. 1500 V DC				
Terminals					
Rear side	Share Bus, DC output, AC input, remote sensing, analog interface, USB-B, master-slave bus, interface module slot				
Front side	USB-A				
Dimensions					
Enclosure (WxHxD)	19" x 3U x 670 mm (26.4")				
Total (WxHxD)	483 x 133 x 774 mm (19" x 5.2x 30.5")				
Weight	~ 25 kg/55.1 lbs.	~ 25 kg/55.1 lbs.	~ 25 kg/55.1 lbs.	~ 25 kg/55.1 lbs.	~ 25 kg/55.1 lbs.

Notes:

1. Related to the nominal values, the accuracy defines the maximum deviation between an adjusted values and the true (actual) value. For example, a 80 V model has min. 0.1% voltage accuracy, that is 80 mV. When adjusting the voltage to 5 V, the actual value is allowed to differ max. 80 mV, which means it might be between 4.92 V and 5.08 V.
2. RMS value: LF 0...300 kHz, PP value: HF 0...20MHz
3. Typical value at 100% output voltage and 100% power
4. The display error adds to the error of the related actual value on the DC output

4.6 15kW 3U HP Models – 208V~480Vac Input (-4)

HP version models provide improved specifications compared to non HP versions and supports a universal wide AC input range. Note that max. output power with US region 208Vac input is only 60% of full rated power.

15kW MODEL	DCS80-510HP ³	DCS200-210HP	DCS360-120HP	DCS500-90HP
Voltage Range	0~80 V	0~200 V	0~360 V	0~500 V
Current Range	0~510 A	0~210 A	0~120 A	0~90 A
CP V-I Range	29.4V@510A ~ 80V@187.5A	71.4V@210A ~ 200V@75A	125V@120A ~ 360V@41.7A	166.7V@90A ~ 500V@30A
Voltage Ripple	<100mVpp <10mVrms	<300mVpp <40mVrms	<320mVpp <55mVrms	<350mVpp <70mVrms
Current Ripple	<240 mArms	<66 mArms	<50 mArms	<48 mArms
Insulation -DC to PE	±600 Vdc	±1000 Vdc	±1000 Vdc	±1500 Vdc
Insulation +DC to PE	+600 Vdc	+1000 Vdc	+1000 Vdc	+2000 Vdc
Power Range ⁴	0~15000 W	0~15000 W	0~15000 W	0~15000 W
Resistance Range	0.02~25 Ω	0.033~50 Ω	0.1~180 Ω	0.16~340 Ω
Output Capacitance	23970 μF	7560 μF	1179 μF	540 μF
Efficiency	94.5%	94.5%	95.5%	95.5%
Weight	31kg/68.3lbs	31kg/68.3lbs	30kg/66.1lbs	31kg/68.3lbs

15kW MODEL	DCS750-60HP	DCS1000-40HP	DCS1500-30HP	DCS2000-20HP
Voltage Range	0~750 V	0~1000 V	0~1500 V	0~2000 V
Current Range	0~60 A	0~40 A	0~30 A	0~20 A
CP V-I Range	250V@60A ~ 750V@20A	375V@40A ~ 1000V@15A	500V@30A ~ 1500V@10A	500V@30A ~ 1500V@10A
Voltage Ripple	<800mVpp <200mVrms	<1600mVpp <300mVrms	<2400mVpp <400mVrms	<2400mVpp <400mVrms
Current Ripple	<48 mArms	<22 mArms	<26 mArms	<26 mArms
Insulation -DC to PE	±1500 Vdc	±1500 Vdc	±1500 Vdc	±1500 Vdc
Insulation +DC to PE	+2000 Vdc	+2000 Vdc	+2000 Vdc	+2000 Vdc
Power Range ⁴	0~15000 W	0~15000 W	0~15000 W	0~15000 W
Resistance Range	0.4~740 Ω	0.8~1300 Ω	2.5~3000 Ω	3.5~5300 Ω
Output Capacitance	540 μF	131 μF	60 μF	60 μF
Efficiency	95.5%	95.5%	95.5%	95.5%
Weight	31kg/68.3lbs	31kg/68.3lbs	31kg/68.3lbs	31kg/68.3lbs

4.7 15kW 3U Models – 380V~480Vac Input (-4)

15 kW	Model				
	DCS80-510-4	DCS200-210-4	DCS360-120-4	DCS500-90-4	DCS750-60-4
AC Input					
Voltage (L-L)	342...528 V AC, 45 - 65 Hz				
Connection	3ph,PE	3ph,PE	3ph,PE	3ph,PE	3ph,PE
Fusing (internal)	6x T16 A	6x T16 A	6x T16 A	6x T16 A	6x T16 A
Leak current	< 3.5 mA	< 3.5 mA	< 3.5 mA	< 3.5 mA	< 3.5 mA
Power factor	> 0.99	> 0.99	> 0.99	> 0.99	> 0.99
DC Output					
Max. output voltage U_{Max}	80 V	200 V	360 V	500 V	750 V
Max. output current I_{Max}	510 A	210 A	120 A	90 A	60 A
Max. output power P_{Max}	15 kW	15 kW	15 kW	15 kW	15 kW
Oversvoltage protection range	0...88 V	0...220 V	0...396 V	0...550 V	0...825 V
Overcurrent protection range	0...561 A	0...231 A	0...132 A	0...99 A	0...66 A
Overpower protection range	0...16.5 kW	0...16.5 kW	0...16.5 kW	0...16.5 kW	0...16.5 kW
Temp. coefficient Δ/K	Voltage / current: 100 ppm				
Output capacitance (approx.)	25380 μF	7560 μF	1200 μF	760 μF	310 μF
Voltage regulation					
Adjustment range	0...81.6 V	0...204 V	0...367.2 V	0...510 V	0...765 V
Accuracy ⁽¹⁾ (at 23±5°C / 73±9°F)	< 0.1% U_{Max}	< 0.1% U_{Max}	< 0.1% U_{Max}	< 0.1% U_{Max}	< 0.1% U_{Max}
Line regulation at ±10% ΔU_{AC}	< 0.02% U_{Max}	< 0.02% U_{Max}	< 0.02% U_{Max}	< 0.02% U_{Max}	< 0.02% U_{Max}
Load regulation at 0...100% load	< 0.05% U_{Max}	< 0.05% U_{Max}	< 0.05% U_{Max}	< 0.05% U_{Max}	< 0.05% U_{Max}
Rise time 10...90% ΔU	Max. 30 ms	Max. 30 ms	Max. 30 ms	Max. 30 ms	Max. 30 ms
Transient time after load step	< 1.5 ms	< 1.5 ms	< 1.5 ms	< 1.5 ms	< 1.5 ms
Display: Accuracy ⁽⁴⁾	≤ 0.2% U_{Max}	≤ 0.2% U_{Max}	≤ 0.2% U_{Max}	≤ 0.2% U_{Max}	≤ 0.2% U_{Max}
Ripple ⁽²⁾	< 320 mV _{pp} < 25 mV	< 300 mV _{pp} < 40 mV	< 550 mV _{pp} < 65 mV	< 350 mV _{pp} < 70 mV	< 800 mV _{pp} < 200 mV
Remote sensing compensation	Max. 5% U_{Max}	Max. 5% U_{Max}	Max. 5% U_{Max}	Max. 5% U_{Max}	Max. 5% U_{Max}
Fall time at no load after switching DC output off	Down from 100% to <60 V: less than 10 s				
Current regulation					
Adjustment range	0...520.2 A	0...214.2 A	0...122.4 A	0...91.8 A	0...61.2 A
Accuracy ⁽¹⁾ (at 23±5°C / 73±9°F)	< 0.2% I_{Max}	< 0.2% I_{Max}	< 0.2% I_{Max}	< 0.2% I_{Max}	< 0.2% I_{Max}
Line regulation at ±10% ΔU_{AC}	< 0.05% I_{Max}	< 0.05% I_{Max}	< 0.05% I_{Max}	< 0.05% I_{Max}	< 0.05% I_{Max}
Load regulation at 0...100% ΔU_{OUT}	< 0.15% I_{Max}	< 0.15% I_{Max}	< 0.15% I_{Max}	< 0.15% I_{Max}	< 0.15% I_{Max}
Ripple ⁽²⁾	< 240 mA _{RMS}	< 66 mA _{RMS}	< 50 mA _{RMS}	< 48 mA _{RMS}	< 48 mA _{RMS}
Display: Accuracy ⁽⁴⁾	≤ 0.2% I_{Max}	≤ 0.2% I_{Max}	≤ 0.2% I_{Max}	≤ 0.2% I_{Max}	≤ 0.2% I_{Max}
Power regulation					
Adjustment range	0...15.3 kW	0...15.3 kW	0...15.3 kW	0...15.3 kW	0...15.3 kW
Accuracy ⁽¹⁾ (at 23±5°C / 73±9°F)	< 1% P_{Max}	< 1% P_{Max}	< 1% P_{Max}	< 1% P_{Max}	< 1% P_{Max}
Line regulation at ±10% ΔU_{AC}	< 0.05% P_{Max}	< 0.05% P_{Max}	< 0.05% P_{Max}	< 0.05% P_{Max}	< 0.05% P_{Max}
Load reg. at 10-90% ΔU_{OUT} * ΔI_{OUT}	< 0.75% P_{Max}	< 0.75% P_{Max}	< 0.75% P_{Max}	< 0.75% P_{Max}	< 0.75% P_{Max}
Display: Accuracy ⁽⁴⁾	≤ 0.8% P_{Max}	≤ 0.8% P_{Max}	≤ 0.85% P_{Max}	≤ 0.85% P_{Max}	≤ 0.85% P_{Max}
Efficiency ⁽³⁾	~ 93%	~ 95%	~ 94%	~ 95%	~ 94%

15 kW	<i>Model</i>				
	<i>DCS80-510-4</i>	<i>DCS200-210-4</i>	<i>DCS360-120-4</i>	<i>DCS500-90-4</i>	<i>DCS750-60-4</i>
Internal resistance regulation					
Adjustment range	0...5 Ω	0...28 Ω	0...90 Ω	0...166 Ω	0...375 Ω
Accuracy ¹	≤1% of max. resistance ± 0.3% of rated current				
Analog interface ²					
Set value inputs	U, I, P, R				
Actual value output	U, I				
Control signals	DC on/off, remote control on/off, resistance mode on/off				
Status signals	CV, OVP, OT				
Galvanic isolation to the unit	Max. 1500 V DC				
Sample rate of inputs & outputs	500 Hz				
Insulation					
Allowed float (potential shift) on the DC output:					
Negative terminal to PE Max.	±400 V DC	±725 V DC	±725 V DC	±1500 V DC	±1500 V DC
Positive terminal to PE Max.	±400 V DC	±1000 V DC	±1000 V DC	±1800 V DC	±1800 V DC
AC input <-> PE	2.5 kV DC				
AC input <-> DC output	2.5 kV DC				
Miscellaneous					
Cooling	Temperature controlled fans, front inlet, rear exhaust				
Ambient temperature	0..50°C (32...122°F)				
Storage temperature	-20...70°C (-4...158°F)				
Humidity	< 80%, not condensing				
Standards	IEC 61010:2010 EMC TÜV approved acc. IEC 61000-6-2:2005 and IEC 61000-6-3:2006 Class B				
Overvoltage category	2				
Protection class	1				
Pollution degree	2				
Operational altitude	< 2000 m (1.242 mi)				
Digital interfaces					
Featured	1x USB-B for communication, 1x USB-A for functions, 1x GPIB (optional on 3U height models only)				
Slot (standard version)	optional: CANopen, Profibus, Profinet, RS232, CAN, Ethernet, ModBus TCP				
Galvanic isolation from unit	Max. 1500 V DC				
Terminals					
Rear side	Share Bus, DC output, AC input, remote sensing, analog interface, USB-B, master-slave bus, interface module slot				
Front side	USB-A				
Dimensions					
Enclosure (WxHxD)	19" x 3U x 670 mm (26.4")				
Total (WxHxD)	483 x 133 x 774 mm (19" x 5.2x 30.5")				
Weight	~ 32 kg/70.5 lbs.	~ 32 kg/70.5 lbs.	~ 32 kg/70.5 lbs.	~ 32 kg/70.5 lbs.	~ 32 kg/70.5 lbs.

Notes:

1. Related to the nominal values, the accuracy defines the maximum deviation between an adjusted values and the true (actual) value. For example, a 80 V model has min. 0.1% voltage accuracy, that is 80 mV. When adjusting the voltage to 5 V, the actual value is allowed to differ max. 80 mV, which means it might be between 4.92 V and 5.08 V.
2. RMS value: LF 0...300 kHz, PP value: HF 0...20MHz
3. Typical value at 100% output voltage and 100% power
4. The display error adds to the error of the related actual value on the DC output

15 kW	<i>Model</i>			
	<i>DCS1000-40-4</i>	<i>DCS1500-30-4</i>		
AC Input				
Voltage (L-L)	342...528 V AC, 45 - 65 Hz			
Connection	3ph,PE	3ph,PE		
Fusing (internal)	6x T16 A	6x T16 A		
Leak current	< 3.5 mA	< 3.5 mA		
Power factor	> 0.99	> 0.99		
DC Output				
Max. output voltage U _{Max}	1000 V	1500 V		
Max. output current I _{Max}	40 A	30 A		
Max. output power P _{Max}	15 kW	15 kW		
Overvoltage protection range	0...1100 V	0...1650 V		
Overcurrent protection range	0...44 A	0...33 A		
Overpower protection range	0...16.5 kW	0...16.5 kW		
Temp. coefficient Δ/K	Voltage / current: 100 ppm			
Output capacitance (approx.)	133 μF	84 μF		
Voltage regulation				
Adjustment range	0...1020 V	0...1560 V		
Accuracy ⁽¹⁾ (at 23±5°C / 73±9°F)	< 0.1% U _{Max}	< 0.1% U _{Max}		
Line regulation at ±10% ΔU _{AC}	< 0.02% U _{Max}	< 0.02% U _{Max}		
Load regulation at 0...100% load	< 0.05% U _{Max}	< 0.05% U _{Max}		
Rise time 10...90% ΔU	Max. 30 ms	Max. 30 ms		
Transient time after load step	< 1.5 ms	< 1.5 ms		
Display: Accuracy ⁽⁴⁾	≤ 0.2% U _{Max}	≤ 0.2% U _{Max}		
Ripple ⁽²⁾	< 2000 mV _{PP} < 300 mV	< 2400 mV _{PP} < 400 mV		
Remote sensing compensation	Max. 5% U _{Max}	Max. 5% U _{Max}		
Fall time at no load after switching DC output off	Down from 100% to <60 V: less than 10 s			
Current regulation				
Adjustment range	0...40.8 A	0...30.6 A		
Accuracy ⁽¹⁾ (at 23±5°C / 73±9°F)	< 0.2% I _{Max}	< 0.2% I _{Max}		
Line regulation at ±10% ΔU _{AC}	< 0.05% I _{Max}	< 0.05% I _{Max}		
Load regulation at 0...100% ΔU _{OUT}	< 0.15% I _{Max}	< 0.15% I _{Max}		
Ripple ⁽²⁾	< 36 mA _{RMS}	< 26 mA _{RMS}		
Display: Accuracy ⁽⁴⁾	≤ 0.2% I _{Max}	≤ 0.2% I _{Max}		
Power regulation				
Adjustment range	0...15.3 kW	0...15.3 kW		
Accuracy ⁽¹⁾ (at 23±5°C / 73±9°F)	< 1% P _{Max}	< 1% P _{Max}		
Line regulation at ±10% ΔU _{AC}	< 0.05% P _{Max}	< 0.05% P _{Max}		
Load reg. at 10-90% ΔU _{OUT} * ΔI _{OUT}	< 0.75% P _{Max}	< 0.75% P _{Max}		
Display: Accuracy ⁽⁴⁾	≤ 0.85% P _{Max}	≤ 0.85% P _{Max}		
Efficiency ⁽³⁾	~ 94%	~ 95%		

15 kW		<i>Model</i>			
		<i>DCS1000-40-4</i>	<i>DCS1500-30-4</i>		
Internal resistance regulation					
Adjustment range	0...1300 Ω	0...1500 Ω			
Accuracy ¹	≤1% of max. resistance ± 0.3% of rated current				
Analog interface ²					
Set value inputs	U, I, P, R				
Actual value output	U, I				
Control signals	DC on/off, remote control on/off, resistance mode on/off				
Status signals	CV, OVP, OT				
Galvanic isolation to the unit	Max. 1500 V DC				
Sample rate of inputs & outputs	500 Hz				
Insulation					
Allowed float (potential shift) on the DC output:					
Negative terminal to PE Max.	±1500 V DC	±1500 V DC			
Positive terminal to PE Max.	±1800 V DC	±1800 V DC			
AC input <-> PE	2.5 kV DC				
AC input <-> DC output	2.5 kV DC				
Miscellaneous					
Cooling	Temperature controlled fans, front inlet, rear exhaust				
Ambient temperature	0..50°C (32...122°F)				
Storage temperature	-20...70°C (-4...158°F)				
Humidity	< 80%, not condensing				
Standards	IEC 61010:2010 EMC TÜV approved acc. IEC 61000-6-2:2005 and IEC 61000-6-3:2006 Class B				
Overvoltage category	2				
Protection class	1				
Pollution degree	2				
Operational altitude	< 2000 m (1.242 mi)				
Digital interfaces					
Featured	1x USB-B for communication, 1x USB-A for functions, 1x GPIB (optional on 3U height models only)				
Slot (standard version)	optional: CANopen, Profibus, Profinet, RS232, CAN, Ethernet, ModBus TCP				
Galvanic isolation from unit	Max. 1500 V DC				
Terminals					
Rear side	Share Bus, DC output, AC input, remote sensing, analog interface, USB-B, master-slave bus, interface module slot				
Front side	USB-A				
Dimensions					
Enclosure (WxHxD)	19" x 3U x 670 mm (26.4")				
Total (WxHxD)	483 x 133 x 774 mm (19" x 5.2x 30.5")				
Weight	~ 32 kg/70.5 lbs.	~ 32 kg/70.5 lbs.			

Notes:

1. Related to the nominal values, the accuracy defines the maximum deviation between an adjusted values and the true (actual) value. For example, a 80 V model has min. 0.1% voltage accuracy, that is 80 mV. When adjusting the voltage to 5 V, the actual value is allowed to differ max. 80 mV, which means it might be between 4.92 V and 5.08 V.
2. RMS value: LF 0...300 kHz, PP value: HF 0...20MHz
3. Typical value at 100% output voltage and 100% power
4. The display error adds to the error of the related actual value on the DC output

4.8 30kW 4U Models – 380V~480Vac Input (-4)

30 kW	Model			
	DCS80-1000-4	DCS200-420-4	DCS360-240-4	DCS500-180-4
AC Input				
Voltage (L-L)	342...528 V AC, 45 - 65 Hz			
Connection	3ph,PE	3ph,PE	3ph,PE	3ph,PE
Fusing (internal)	6x T32 A	6x T32 A	6x T32 A	6x T32 A
Leak current	< 3.5 mA	< 3.5 mA	< 3.5 mA	< 3.5 mA
Phase Current	56 Arms Max.			
Power factor	> 0.99	> 0.99	> 0.99	> 0.99
DC Output				
Max. output voltage U_{Max}	80 V	200 V	360 V	500 V
Max. output current I_{Max}	1000 A	420 A	240 A	180 A
Max. output power P_{Max}	30 kW	30 kW	30 kW	30 kW
Overvoltage protection range	0...88 V	0...220 V	0...396 V	0...550 V
Overcurrent protection range	0...1100 A	0...462 A	0...264 A	0...198 A
Overpower protection range	0...33.0 kW	0...33.0 kW	0...33.0 kW	0...33.0 kW
Temp. coefficient Δ/K	Voltage / current: 100 ppm			
Output capacitance (approx.)	25380 μF	5400 μF	1800 μF	675 μF
Voltage regulation				
Adjustment range	0...81.6 V	0...204 V	0...367.2 V	0...510 V
Accuracy ⁽¹⁾ (at 23 \pm 5 $^{\circ}$ C / 73 \pm 9 $^{\circ}$ F)	< 0.05% U_{Max}	< 0.05% U_{Max}	< 0.05% U_{Max}	< 0.05% U_{Max}
Line regulation at $\pm 10\%$ ΔU_{AC}	< 0.02% U_{Max}	< 0.02% U_{Max}	< 0.02% U_{Max}	< 0.02% U_{Max}
Display: Accuracy ⁽³⁾	$\leq 0.2\%$ U_{Max}	$\leq 0.2\%$ U_{Max}	$\leq 0.2\%$ U_{Max}	$\leq 0.2\%$ U_{Max}
Remote sensing compensation	Max. 5% U_{Max}	Max. 5% U_{Max}	Max. 5% U_{Max}	Max. 5% U_{Max}
Load regulation at 0...100% load	< 0.05% U_{Max}	< 0.05% U_{Max}	< 0.05% U_{Max}	< 0.05% U_{Max}
Rise time 10...90% ΔU	Max. 30 ms	Max. 30 ms	Max. 30 ms	Max. 30 ms
Transient time after load step	< 1.5 ms	< 1.5 ms	< 1.5 ms	< 1.5 ms
Ripple ⁽²⁾	< 320 mV _{pp} < 25 mV _{RMS}	< 300 mV _{pp} < 40 mV _{RMS}	< 320 mV _{pp} < 55 mV _{RMS}	< 350 mV _{pp} < 70 mV _{RMS}
Fall time at no load after switching DC output off	Down from 100% to < 60 V: less than 10 s			
Current regulation				
Adjustment range	0...1020 A	0...428.4 A	0...244.8 A	0...183.6 A
Accuracy ⁽¹⁾ (at 23 \pm 5 $^{\circ}$ C / 73 \pm 9 $^{\circ}$ F)	< 0.1% I_{Max}	< 0.1% I_{Max}	< 0.1% I_{Max}	< 0.1% I_{Max}
Line regulation at $\pm 10\%$ ΔU_{AC}	< 0.05% I_{Max}	< 0.05% I_{Max}	< 0.05% I_{Max}	< 0.05% I_{Max}
Display: Accuracy ⁽³⁾	$\leq 0.2\%$ I_{Max}	$\leq 0.2\%$ I_{Max}	$\leq 0.2\%$ I_{Max}	$\leq 0.2\%$ I_{Max}
Load regulation at 0...100% ΔU_{OUT}	< 0.15% I_{Max}	< 0.15% I_{Max}	< 0.15% I_{Max}	< 0.15% I_{Max}
Power regulation				
Adjustment range	0...30.6 kW	0...30.6 kW	0...30.6 kW	0...30.6 kW
Accuracy ⁽¹⁾ (at 23 \pm 5 $^{\circ}$ C / 73 \pm 9 $^{\circ}$ F)	< 0.3% P_{Max}	< 0.3% P_{Max}	< 0.3% P_{Max}	< 0.3% P_{Max}
Line regulation at $\pm 10\%$ ΔU_{AC}	< 0.05% P_{Max}	< 0.05% P_{Max}	< 0.05% P_{Max}	< 0.05% P_{Max}
Load reg. at 10-90% ΔU_{OUT} * ΔI_{OUT}	< 0.75% P_{Max}	< 0.75% P_{Max}	< 0.75% P_{Max}	< 0.75% P_{Max}
Display: Accuracy ⁽³⁾	$\leq 0.2\%$ P_{Max}	$\leq 0.2\%$ P_{Max}	$\leq 0.2\%$ P_{Max}	$\leq 0.2\%$ P_{Max}
Efficiency ⁽³⁾	$\sim 94\%$	$\sim 94\%$	$\sim 94.6\%$	$\sim 95.3\%$

Note 1: Related to the nominal values, the accuracy defines the maximum deviation between an adjusted values and the true (actual) value. Example: an 80 V model has min. 0.1% voltage accuracy or 80 mV. When adjusting the voltage to 5 V, the actual value is allowed to differ max. 80 mV, which means it may be between 4.92 V and 5.08 V.

Note 2: RMS value: LF 0...300 kHz, PP value: HF 0...20MHz

Note 3: The display error adds to the error of the related actual value on the DC terminal

30 kW	<i>Model</i>			
	<i>DCS80-1000-4</i>	<i>DCS200-420-4</i>	<i>DCS360-240-4</i>	<i>DCS500-180-4</i>
Internal resistance regulation				
Adjustment range	0.003 - 5 Ω	0.016 - 25 Ω	0.05 - 90 Ω	0.08 - 170 Ω
Accuracy ⁽¹⁾	≤ 0.3% of max. resistance ± 0.3% of rated current			
Analog interface ⁽⁵⁾				
Set value inputs	U, I, P, R			
Actual value output	U, I			
Control signals	DC on/off, remote control on/off, resistance mode on/off			
Status signals	CV, OVP, OT			
Galvanic isolation to the unit	Max. 1500 V DC			
Sample rate of inputs & outputs	500 Hz			
Insulation				
Allowed float (potential shift) on the DC output:				
Negative terminal to PE Max.	±500 V DC	±800 V DC	±1500 V DC	±1500 V DC
Positive terminal to PE Max.	±600 V DC	±1000 V DC	±2000 V DC	±2000 V DC
AC input <-> PE	2.5 kV DC			
AC input <-> DC output	2.5 kV DC			
Miscellaneous				
Cooling	Temperature controlled fans, front inlet, rear exhaust			
Ambient temperature	0..50°C (32...122°F)			
Storage temperature / Humidity	-20...70°C (-4...158°F) / < 80%, not condensing			
Standards	EN 61010-1:2007-11. EN 50160:2011-02 EN 61000-6-2:2016-05. EN 61000-6-3:2011-09			
Overvoltage category	2			
Protection class	1			
Pollution degree	2			
Operational altitude	< 2000 m (1.242 mi)			
Digital interfaces				
Featured	1x USB-B for communication, 1x USB-A for functions			
Slot (standard version)	optional: CANopen, Profibus, Profinet, RS232, CAN, Ethernet			
Galvanic isolation from unit	Max. 1500 V DC			
Terminals				
Rear side	Share Bus, DC output, AC input, remote sensing, analog interface, USB-B, master-slave bus, interface module slot			
Front side	USB-A			
Dimensions				
Enclosure (WxHxD)	19" x 4U x 670 mm (26.4")			
Total (WxHxD)	483 x 178 x 775 mm (19" x 7" x 30.5")			
Weight	~ 50 kg/110 lbs.	~ 50 kg/110 lbs.	~ 50 kg/110 lbs.	~ 50 kg/110 lbs.

Note 1: Related to the nominal values, the accuracy defines the maximum deviation between an adjusted values and the true (actual) value. With the resistance, the accuracy rating already includes the error of the actual resistance display.

Note 2: RMS value: LF 0...300 kHz, PP value: HF 0...20MHz

Note 3: The display error adds to the error of the related actual value on the DC terminal

Note 4: Typical value at 100% voltage and 100% power

Note 5: For technical specifications of the analog interface, section 6.4.3.4 on page **Error! Bookmark not defined.**

30 kW	<i>Model</i>			
	<i>DCS750-120-4</i>	<i>DCS1000-80-4</i>	<i>DCS1500-60-4</i>	<i>DCS2000-40-4</i>
AC Input				
Voltage (L-L)	342...528 V AC, 45 - 65 Hz			
Connection	3ph,PE	3ph,PE	3ph,PE	3ph,PE
Fusing (internal)	6x T32 A	6x T32 A	6x T32 A	6x T32 A
Leak current	< 3.5 mA	< 3.5 mA	< 3.5 mA	< 3.5 mA
Phase Current	56 Arms Max.			
Power factor	> 0.99	> 0.99	> 0.99	> 0.99
DC Output				
Max. output voltage U _{Max}	750 V	1000 V	1500 V	2000 V
Max. output current I _{Max}	120 A	80 A	60 A	40 A
Max. output power P _{Max}	30 kW	30 kW	30 kW	30 kW
Overvoltage protection range	0...825 V	0...1100 V	0...1650 V	0...2200 V
Overcurrent protection range	0...132 A	0...88 A	0...66 A	0...44 A
Overpower protection range	0...33.0 kW	0...33.0 kW	0...33.0 kW	0...33.0 kW
Temp. coefficient Δ/K	Voltage / current: 100 ppm			
Output capacitance (approx.)	450 μF	200 μF	75 μF	50 μF
Voltage regulation				
Adjustment range	0...765 V	0...1020 V	0...1560 V	0...2040 V
Accuracy ⁽¹⁾ (at 23±5°C / 73±9°F)	< 0.05% U _{Max}	< 0.05% U _{Max}	< 0.05% U _{Max}	< 0.05% U _{Max}
Line regulation at ±10% ΔU _{AC}	< 0.02% U _{Max}	< 0.02% U _{Max}	< 0.02% U _{Max}	< 0.02% U _{Max}
Display: Accuracy ⁽³⁾	≤ 0.2% U _{Max}	≤ 0.2% U _{Max}	≤ 0.2% U _{Max}	≤ 0.2% U _{Max}
Remote sensing compensation	Max. 5% U _{Max}	Max. 5% U _{Max}	Max. 5% U _{Max}	Max. 5% U _{Max}
Load regulation at 0...100% load	< 0.05% U _{Max}	< 0.05% U _{Max}	< 0.1% U _{Max}	< 0.1% U _{Max}
Rise time 10...90% ΔU	Max. 30 ms	Max. 30 ms	< 0.02% U _{Max}	< 0.02% U _{Max}
Transient time after load step	< 2 ms	< 2 ms	< 2 ms	< 2 ms
Ripple ⁽²⁾	< 800 mV _{PP} < 200 mV _{RMS}	< 1600 mV _{PP} < 300 mV _{RMS}	< 2400 mV _{PP} < 400 mV _{RMS}	< 2400 mV _{PP} < 400 mV _{RMS}
Fall time at no load after switching DC output off	Down from 100% to <60 V: less than 10 s			
Current regulation				
Adjustment range	0...122.4 A	0...81.6 A	0...61.2 A	0...40.8 A
Accuracy ⁽¹⁾ (at 23±5°C / 73±9°F)	< 0.2% I _{Max}	< 0.2% I _{Max}	< 0.2% I _{Max}	< 0.2% I _{Max}
Line regulation at ±10% ΔU _{AC}	< 0.05% I _{Max}	< 0.05% I _{Max}	< 0.05% I _{Max}	< 0.05% I _{Max}
Display: Accuracy ⁽³⁾	≤ 0.2% I _{Max}	≤ 0.2% I _{Max}	≤ 0.2% I _{Max}	≤ 0.2% I _{Max}
Load regulation at 0...100% ΔU _{OUT}	< 0.15% I _{Max}	< 0.15% I _{Max}	< 0.15% I _{Max}	< 0.15% I _{Max}
Power regulation				
Adjustment range	0...30.6 kW	0...30.6 kW	0...30.6 kW	0...30.6 kW
Accuracy ⁽¹⁾ (at 23±5°C / 73±9°F)	< 0.3% P _{Max}	< 0.3% P _{Max}	< 0.3% P _{Max}	< 0.3% P _{Max}
Line regulation at ±10% ΔU _{AC}	< 0.05% P _{Max}	< 0.05% P _{Max}	< 0.05% P _{Max}	< 0.05% P _{Max}
Load reg. at 10-90% ΔU _{OUT} * ΔI _{OUT}	< 0.75% P _{Max}	< 0.75% P _{Max}	< 0.75% P _{Max}	< 0.75% P _{Max}
Display: Accuracy ⁽³⁾	≤ 0.2% P _{Max}	≤ 0.2% P _{Max}	≤ 0.2% P _{Max}	≤ 0.2% P _{Max}
Efficiency ⁽³⁾	~ 95.5%	~ 94.6%	~ 95.3%	~ 95.5%

Note 1: Related to the nominal values, the accuracy defines the maximum deviation between an adjusted values and the true (actual) value. Example: an 80 V model has min. 0.1% voltage accuracy or 80 mV. When adjusting the voltage to 5 V, the actual value is allowed to differ max. 80 mV, which means it may be between 4.92 V and 5.08 V.

Note 2: RMS value: LF 0...300 kHz, PP value: HF 0...20MHz

Note 3: The display error adds to the error of the related actual value on the DC terminal

30 kW	<i>Model</i>			
	<i>DCS750-120-4</i>	<i>DCS1000-80-4</i>	<i>DCS1500-60-4</i>	<i>DCS2000-40-4</i>
Internal resistance regulation				
Adjustment range	0.2 - 370 Ω	0.4 - 650 Ω	1.25 - 1500 Ω	1.8 - 2700 Ω
Accuracy ⁽¹⁾	≤ 0.3 % of max. resistance ± 0.3% of rated current			
Analog interface ⁽⁵⁾				
Set value inputs	U, I, P, R			
Actual value output	U, I			
Control signals	DC on/off, remote control on/off, resistance mode on/off			
Status signals	CV, OVP, OT			
Galvanic isolation to the unit	Max. 1500 V DC			
Sample rate of inputs & outputs	500 Hz			
Insulation				
Allowed float (potential shift) on the DC output:				
Negative terminal to PE Max.	±1500 V DC	±1500 V DC	±1500 V DC	±1500 V DC
Positive terminal to PE Max.	±2000 V DC	±2000 V DC	±2000 V DC	±2000 V DC
AC input <-> PE	2.5 kV DC			
AC input <-> DC output	2.5 kV DC			
Miscellaneous				
Cooling	Temperature controlled fans, front inlet, rear exhaust			
Ambient temperature	0..50°C (32...122°F)			
Storage temperature	-20...70°C (-4...158°F)			
Humidity	< 80%, not condensing			
Standards	EN 61010-1:2007-11. EN 50160:2011-02 EN 61000-6-2:2016-05. EN 61000-6-3:2011-09			
Overvoltage category	2			
Protection class	1			
Pollution degree	2			
Operational altitude	< 2000 m (1.242 mi)			
Digital interfaces				
Featured	1x USB-B for communication, 1x USB-A for functions			
Slot (standard version)	optional: CANopen, Profibus, Profinet, RS232, CAN, Ethernet			
Galvanic isolation from unit	Max. 1500 V DC			
Terminals				
Rear side	Share Bus, DC output, AC input, remote sensing, analog interface, USB-B, master-slave bus, interface module slot			
Front side	USB-A			
Dimensions				
Enclosure (WxHxD)	19" x 4U x 670 mm (26.4")			
Total (WxHxD)	483 x 178 x 775 mm (19" x 7" x 30.5")			
Weight	~ 50 kg/110 lbs.	~ 50 kg/110 lbs.	~ 50 kg/110 lbs.	~ 50 kg/110 lbs.

Note 1: Related to the nominal values, the accuracy defines the maximum deviation between an adjusted values and the true (actual) value. With the resistance, the accuracy rating already includes the error of the actual resistance display.

Note 2: RMS value: LF 0...300 kHz, PP value: HF 0...20MHz

Note 3: The display error adds to the error of the related actual value on the DC terminal

Note 4: Typical value at 100% voltage and 100% power

Note 5: For technical specifications of the analog interface, section 6.4.3.4 on page **Error! Bookmark not defined.**

4.9 Mechanical Chassis Outlines – 3U Models

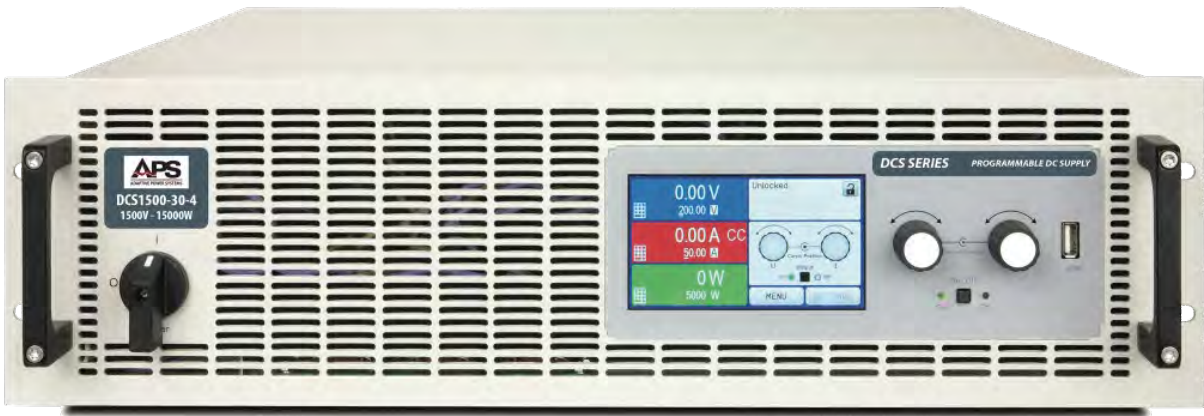

Front view

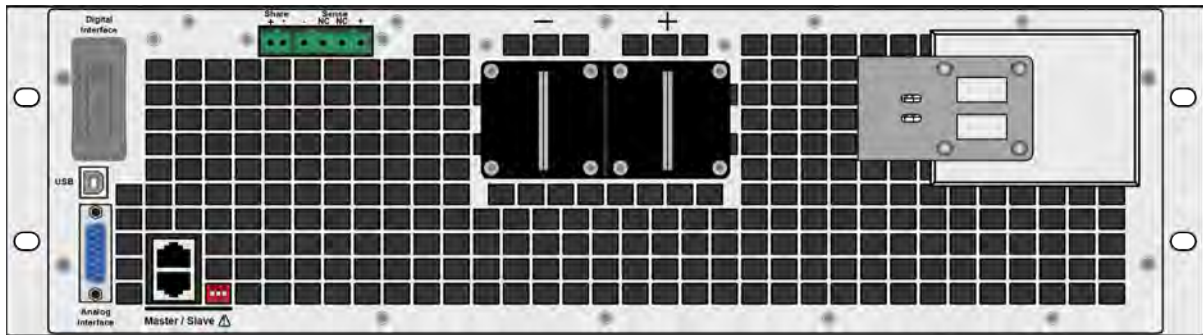

Rear Panel

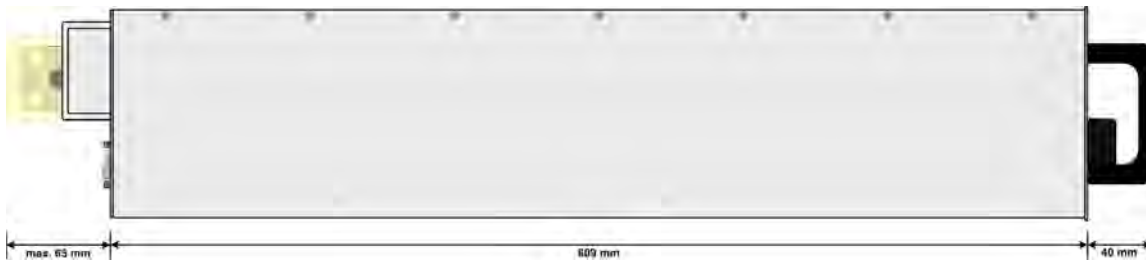

Left Side

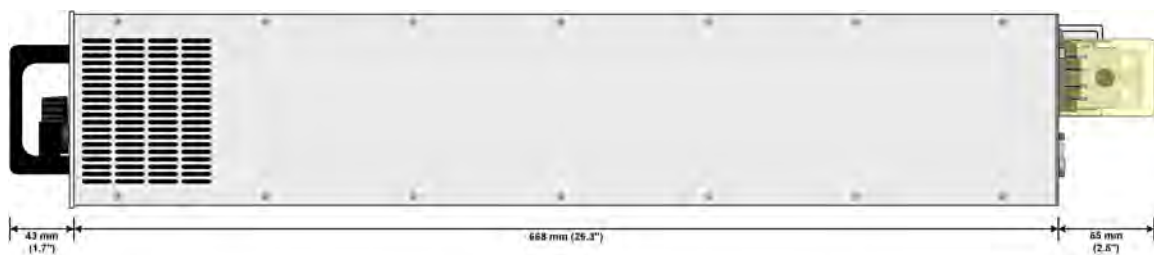

Right Side



Top view

4.1 Mechanical Chassis Outlines – 4U Models

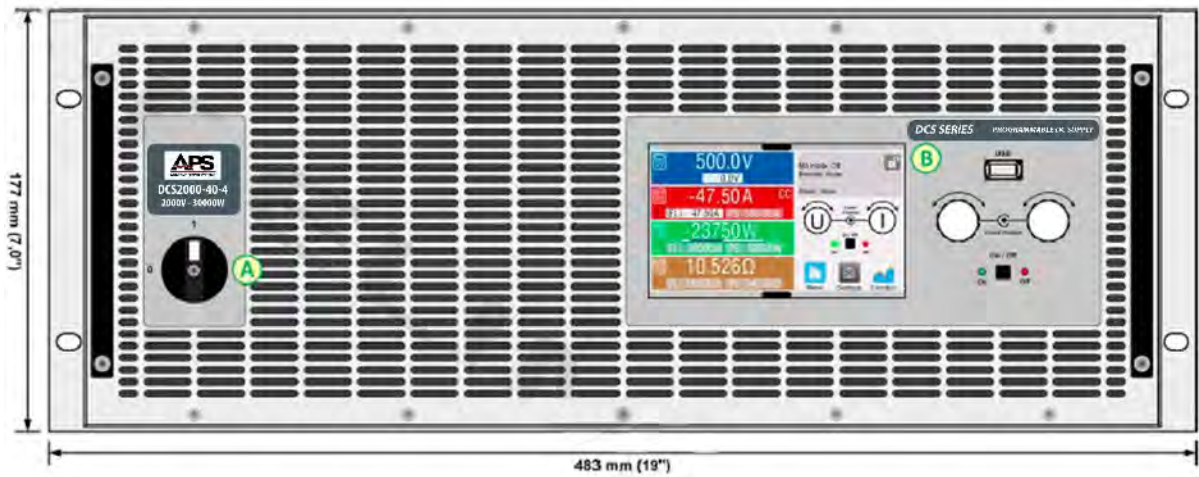

Front view

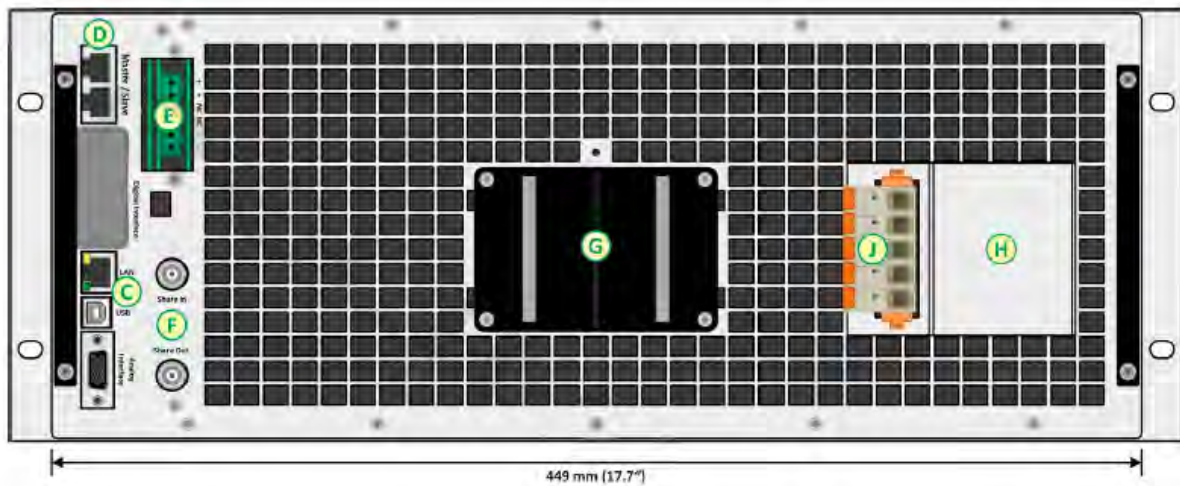

Rear Panel

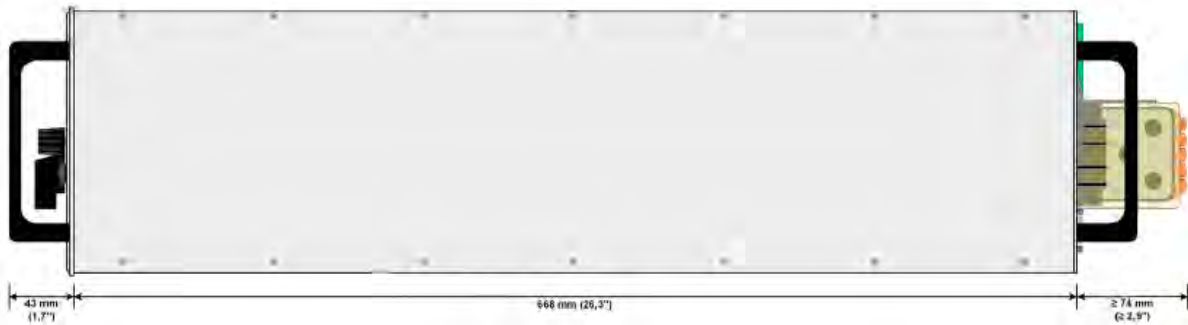

Right Side

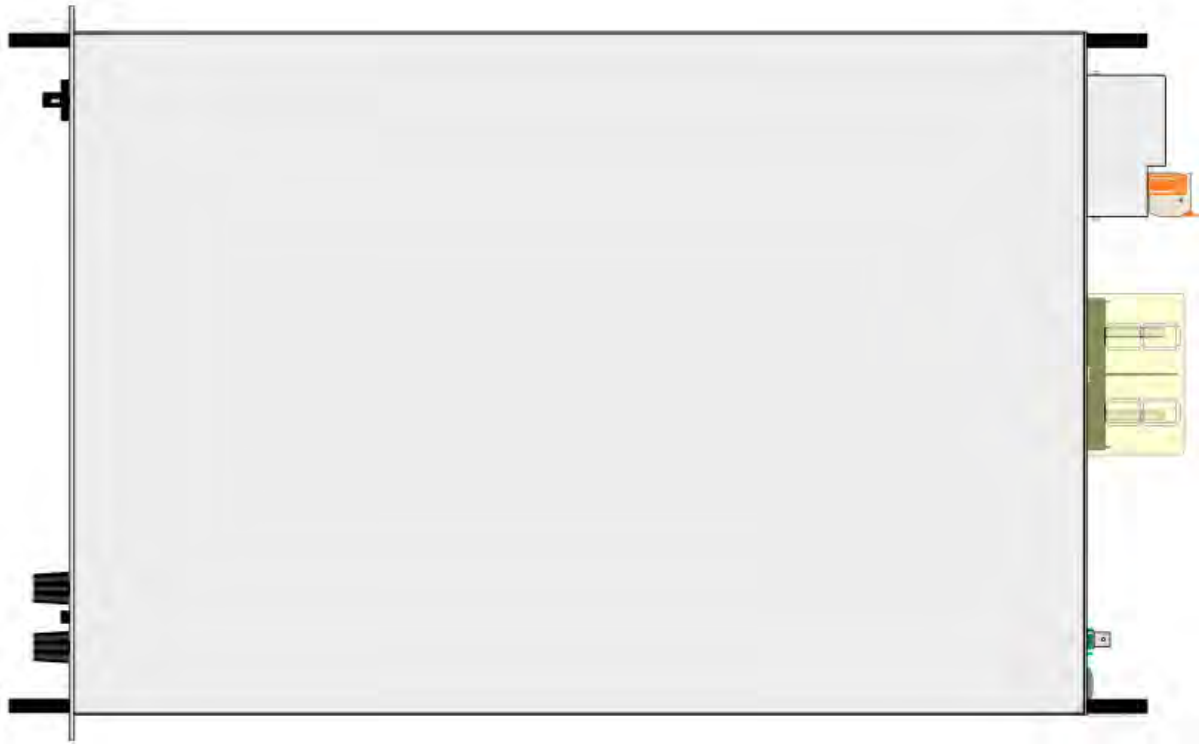

Top view

4.1.1 Water Cooled Version – 4U

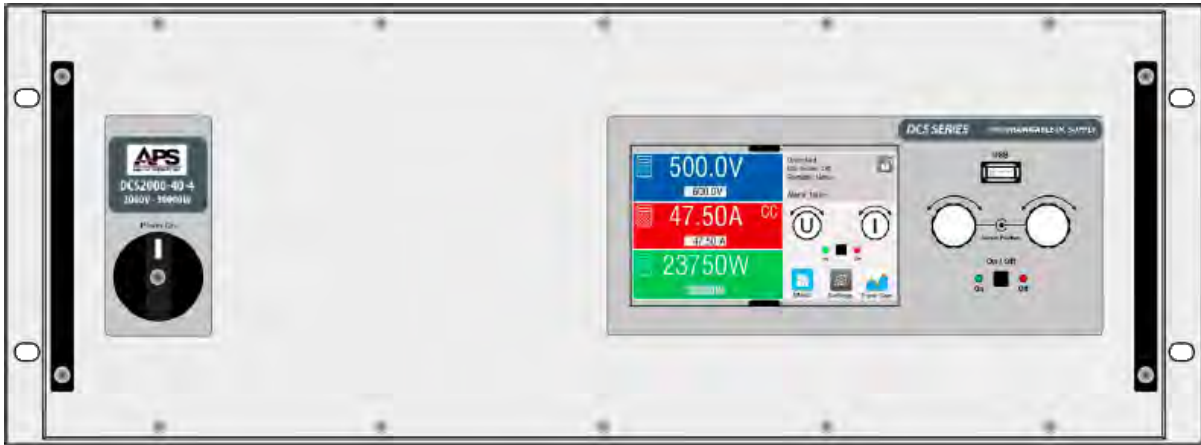

Front View (water cooled)

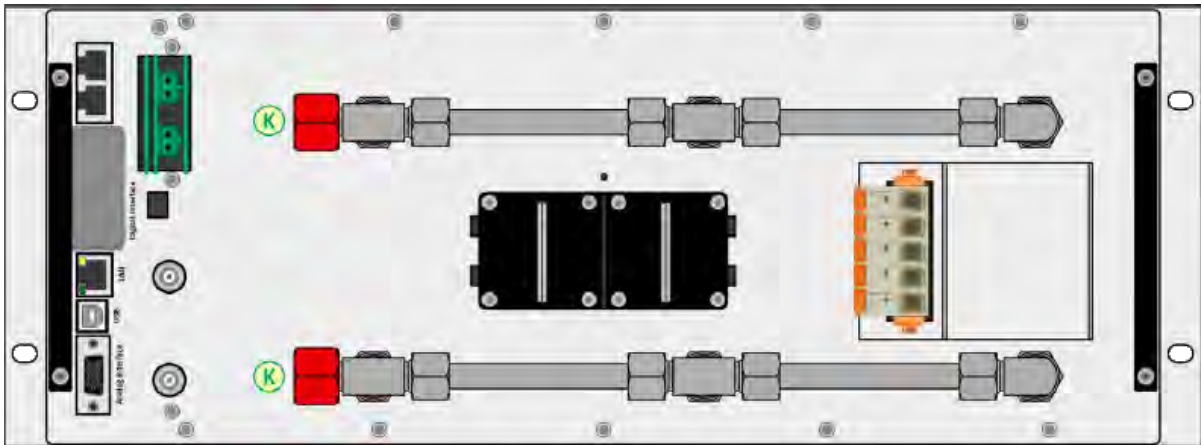

Rear View (water cooled)

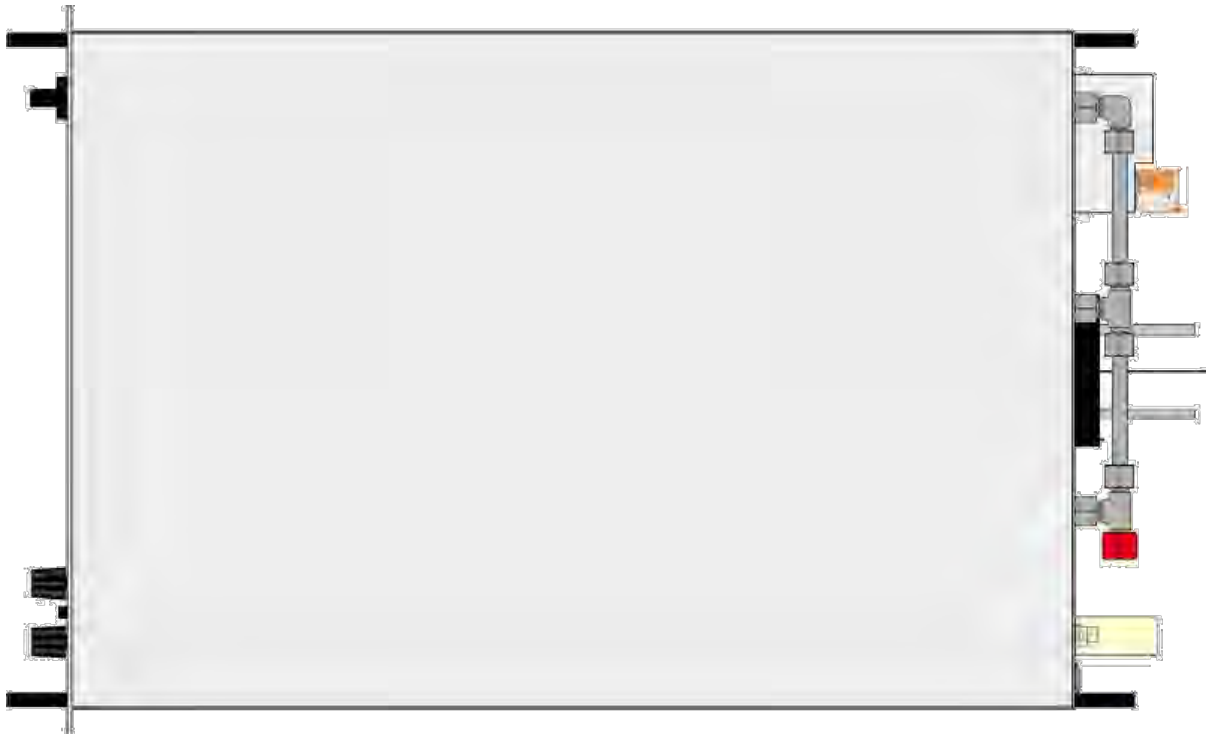

Top View (water cooled)

5 Unpacking and Installation

5.1 Packaging

It is strongly recommend to retain the original packaging used to ship the unit in case the unit ever needs to be returned for service or sent to a different location for re-deployment. The original packaging will provide proper protection for the unit during transport.

If the unit is to be stored for an extended period, use of the original packaging is recommended as well.

If retention is not possible or desired, the packaging should be disposed of in an environmentally responsible way.

5.2 Inspection

The DCS Series of DC power supplies are carefully inspected before shipment. Upon receipt and unpacking, always perform a careful visual inspection of the unit and the included ship kit accessories. If instrument damage has occurred during transport, please inform Adaptive Power Systems' nearest sales and service office or representative.



Note: Do not connect a visibly damaged unit to the mains and attempt to use.

5.3 Ship Kit

The following items are including in the unit’s ship kit. The ship kit is normally placed on top of the unit in its shipping box or container. **Do not** throw out the ship kit with the packaging of the unit.

Item	Description	Quantity
A	Share Bus plug	1
B	Remote sensing plug	1
C	1.8 m USB cable	1
D	Set of DC terminal covers	1 Set
E	Share/Sense terminal cover (only for models from 750 V)	1
F	USB stick with documentation and software	1
G	AC connector plug (clamp type)	1
H	Set for strain relief (pre-mounted)	1 Set

Table 5-1: Ship Kit Content

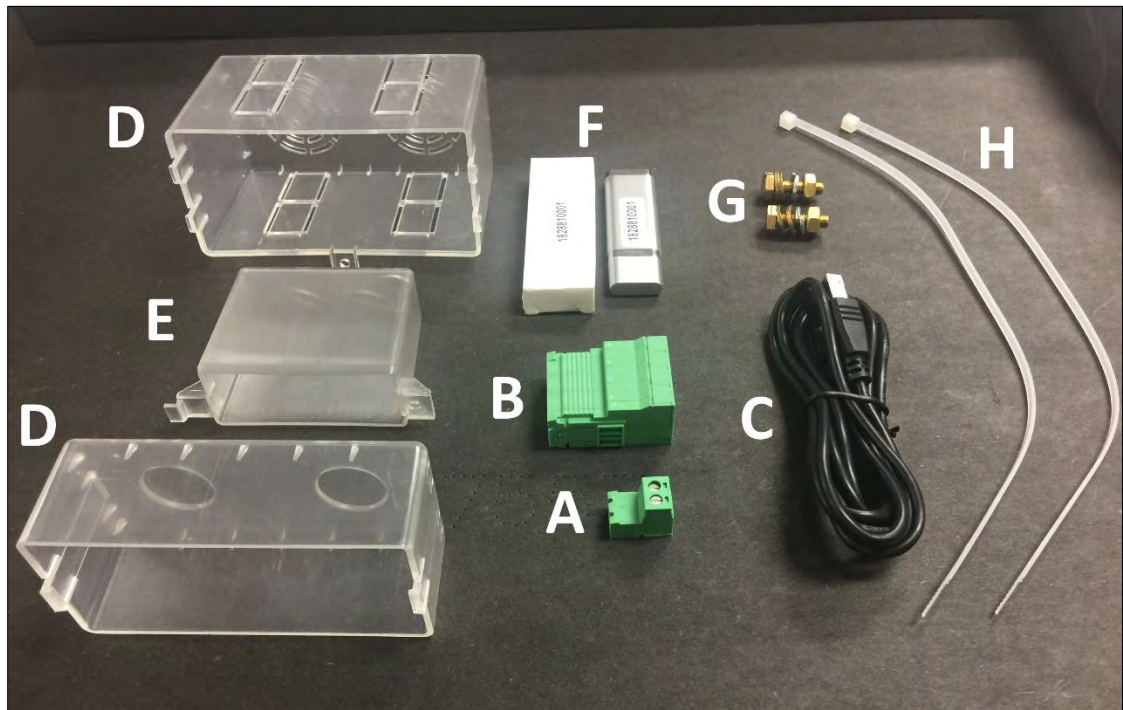

Figure 5-2: DCS Series Ship Kit Content

5.4 Check AC Line Voltage

The DCS Series power supply can be ordered with one of two available 3-phase AC input voltage configurations. Prior to connecting the DC power supply to the local mains, it is important to check the type label on the unit to verify that its AC input configuration matches the local utility power.



Note: Do not connect the power supply to the mains if the AC input voltage, phasing and frequency does not match.

5.5 Rear Panel Connections

All connections for input power and output DC power are made at the rear panel of the units. The same applies to digital interfaces and Analog I/O. The rear panel also contains the Share bus connectors. See reference image below.

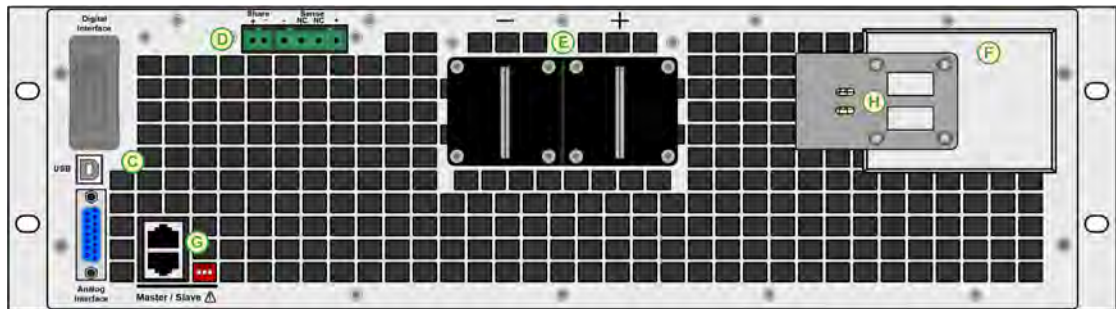

Rear panel connectors legend:

<i>C</i>	<i>Control Interface (Analog/Digital)</i>	<i>D</i>	<i>Share bus and remote voltage sensing connector</i>
<i>E</i>	<i>DC output (Terminal Type 1 shown)</i>	<i>F</i>	<i>AC Input Connection</i>
<i>G</i>	<i>Master/Slave Ports</i>	<i>H</i>	<i>AC Input plug fixture and strain relief</i>

5.6 AC Input Connections

5.6.1 Mains Supply

The equipment is delivered with a 5-pole mains plug. Depending on model, this will be connected with a 2-phase or 3-phase mains supply, which has to be connected according to the labelling on the plug. Required for the mains connection are following phases:

Nominal power	Phases	Supply type
5 kW	L2, L3, PE	Three-phase
10 - 15 kW, > 15 kW	L1, L2, L3, PE	Three-phase

5.6.2 Wire Sizing – 208V AC Input “-2” Models

For the sizing of wiring cross section, the power intake of the unit and the cable length are decisive. The table below gives the maximum input current for each phase.

Based on the connection of a **stand-alone unit**:

Nominal power	L1		L2		L3	
	∅	I _{ma}	∅	I _{ma}	∅	I _{ma}
5 kW	-	-	AWG 12	32 A	AWG 12	32 A
10 kW	AWG 8	56 A	AWG 8	32 A	AWG 8	32 A
15 kW	AWG 8	56 A	AWG 8	56 A	AWG 8	56 A

5.6.3 Wire Sizing – 380V-480V AC Input “-4” Models

For the sizing of wiring cross section, the power intake of the unit and the cable length are decisive. The table below gives the maximum input current for each phase.

Based on the connection of a **stand-alone unit**:

Nominal power	L1		L2		L3	
	∅	I _{ma}	∅	I _{ma}	∅	I _{ma}
5 kW	-	-	2,5 mm ²	16 A	2,5 mm ²	16 A
10 kW	4 mm ²	28 A	4 mm ²	16 A	4 mm ²	16 A
15 kW	4 mm ²	28 A	4 mm ²	28 A	4 mm ²	28 A
30 kW	10 mm ²	56 A	10 mm ²	56 A	10 mm ²	56 A

5.6.4 AC Line Cord – 208Vac “-2” Models

The included connection plug can receive soldered cable ends or such with cable end sleeves of up to 16 mm² (AWG 6) for 208Vac “-2” models. The longer the connection cable, the higher the voltage loss due to the cable resistance. Therefore, the mains cables should be kept as short as possible or use a bigger cross section. If possible, all three phase of a three-phase supply should be wired so that no phase is missing if the cable is going to be used for another model with different power rating.

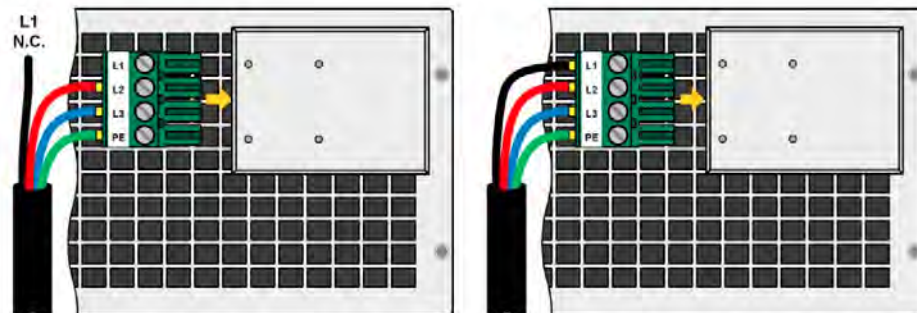

Figure 5-3: AC Input Mating Connector- 3U Models - (Cable shown not included)

The 4U chassis height -2 208V AC input models are also delivered with a 5 pole AC plug. This plug is connected to 3-phase AC supply, according to the labeling next the plug (filter housing). Required are following phases:

Rated power	Inputs on AC plug	Supply type	Configuration
15 kW	L1, L2, L3, (N), PE	Three-phase (3P)	Delta

Note: The PE (Protective Earth) connection is imperative and must always be connected.

The Neutral wire, if present on the power cable used, can be wired to the free position on the AC plug.

The included connection plug can receive lose/soldered cable ends of up to 16 mm² (AWG 6). The longer the connection cable, the higher the voltage loss due to the cable resistance. Therefore the mains cables should be kept as short as possible or use bigger cross section. Connection scheme is shown in the figure below.

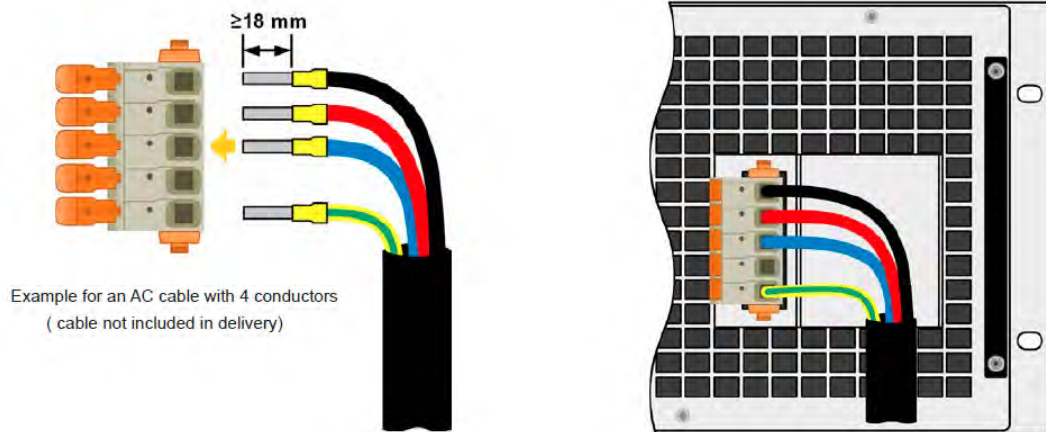

Figure 5-4: AC Input Mating Connector 208V – 4U Models – 4 Wire

5.6.1 AC Line Cord – 380V~480Vac “-4” Models

The included connection plug can receive soldered cable ends or such with cable end sleeves of up to 6 mm² for 380V~480Vac “-4” models. The longer the connection cable, the higher the voltage loss due to the cable resistance. Therefore, the mains cables should be kept as short as possible or use a bigger cross section. If possible, all three phase of a three-phase supply should be wired so that no phase is missing if the cable is going to be used for another model with different power rating.

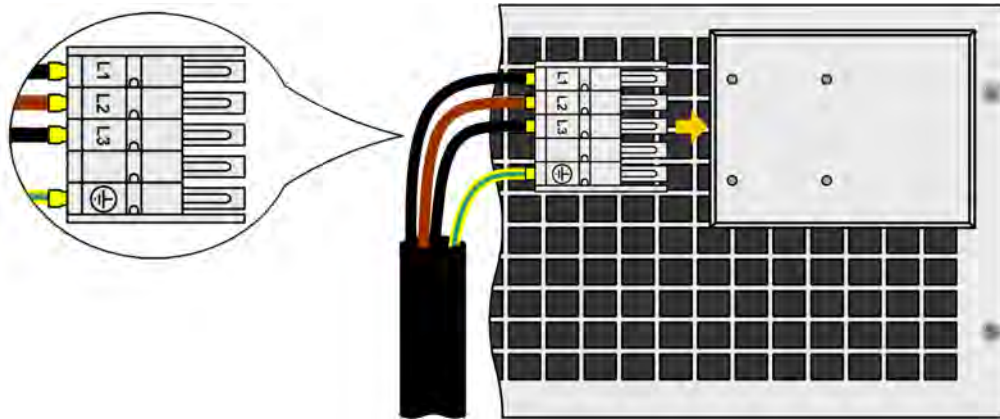

Figure 5-5: AC Input Mating Connector 480V – 3U Models - (Cable shown not included)

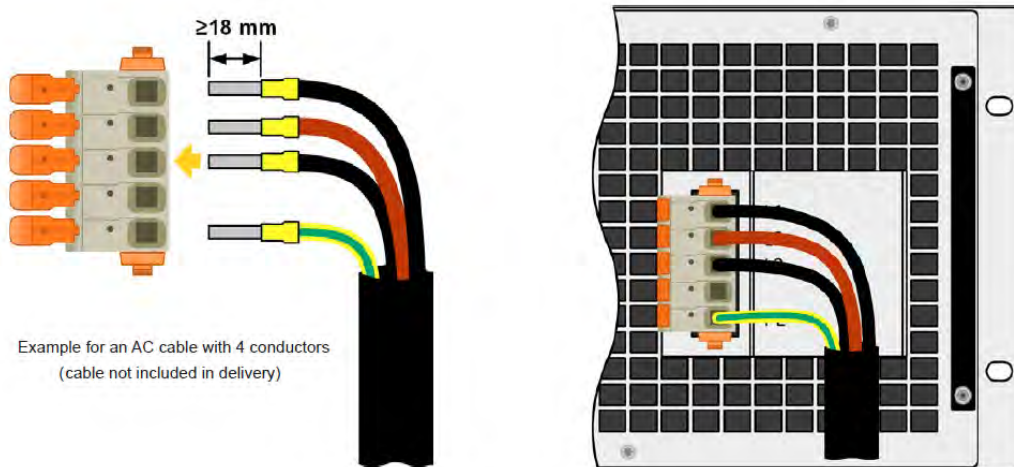

Figure 5-6: AC Input Mating Connector 480V – 4U Models – 4 Wire

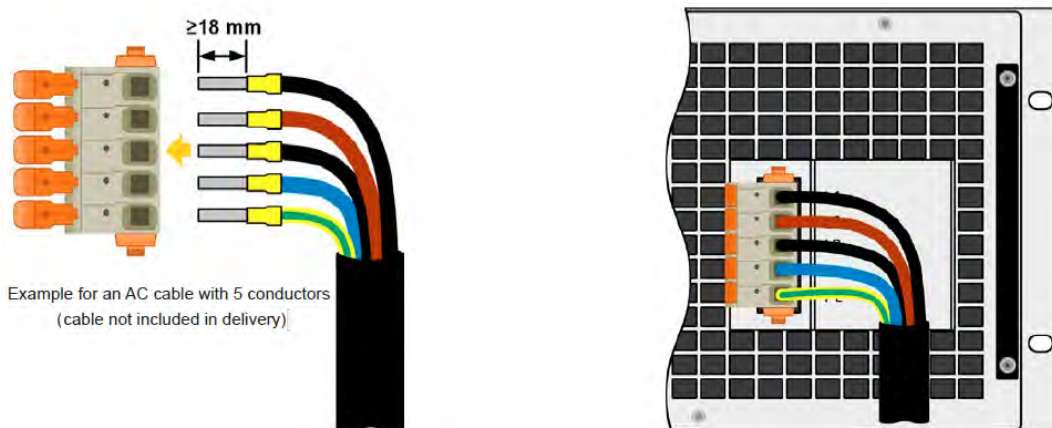

Figure 5-7: AC Input Mating Connector 480V – 4U Models – 5 Wire

5.6.2 Strain Relief and plug fixture

There is a standard fixture mounted to the AC input connector block on the rear. It is used to prevent the AC plug from loosening and disconnecting due to vibrations or other mechanical shock. The same fixture is also used as strain relief.

Using the 4x M3 nuts, it is recommended to mount the fixture to the AC filter block every time the AC plug has been unplugged and plugged in again.

It is furthermore recommended to install the strain relief by using suitable cable straps (not included), as depicted in the figure to the right.

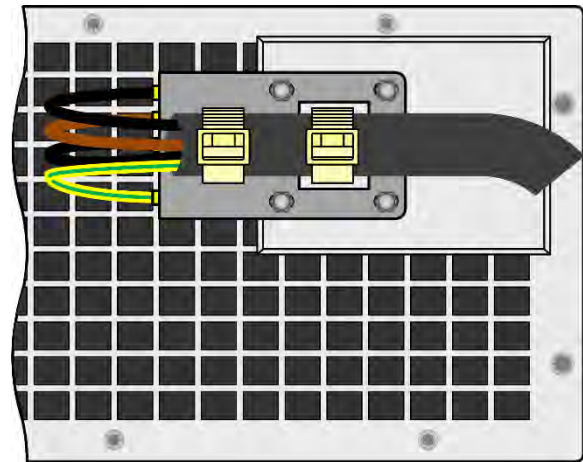

5.6.3 Grid Connection Variations

Depending on the max. output power rating of a certain model, it requires two or three phases of a three-phase AC supply. In case multiple units with 5kW or 10 kW power rating are connected to the same mains connection, it is important to ensure balanced current distribution on the three phases. The tables in paragraph 5.6.2 or 5.6.3 shows the phase currents.

The 15 kW models consume balanced current on all three phases. As long as only 15kW models are installed, no unbalanced AC load is expected. Mixed systems with units of different power ratings are not automatically balanced. Load balance can be achieved however given a certain number of units by calculation based on phase currents per unit.

5.6.4 Suggestions for phase assignments:

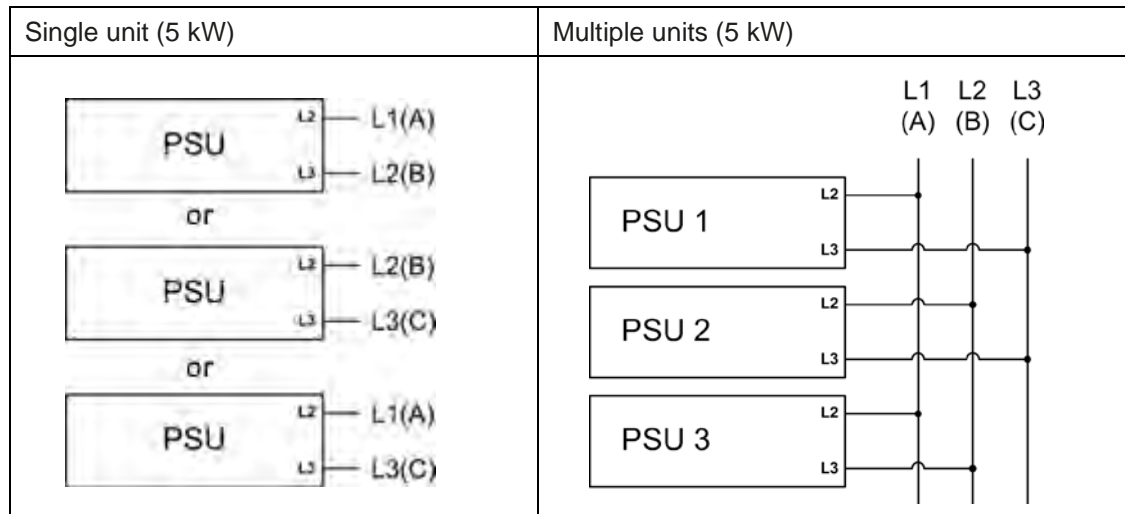

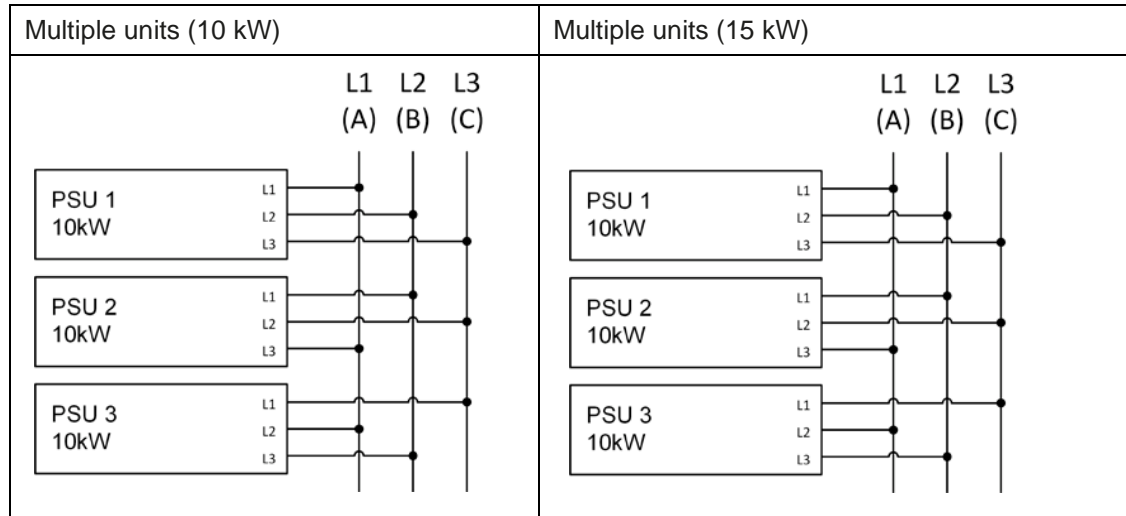

5.6.5 AC Input Fuses

This product is fitted with internal mains input fuses. If any of these need to be replaced, please contact customer service.

This unit is protected by up to six 6.3 x 32 mm fuses (500 V, ceramic) inside the unit. **Check the fuse rating for the DC Mode based on input voltage configuration in section 4, “Technical Specifications” on page 28.** To replace these, the unit must first be disconnected from the AC supply. Allow 15 minutes for any charged internal circuits to fully discharge. Remove the top cover to access the 1 to 3 power modules in black plastic housings, each of which holds two of the fuses.



Note: Removing the top cover and replacing fuses should only be performed by trained and qualified personnel.

Step 1: Opening the unit

1. Switch off at the mains switch and remove plug.
2. Remove the top cover of the unit (5 screws at the back, 5 on the front, 7 on each side, all Torx 10)
3. Remove the plastic cover(s) of the power modules.

Step 2: Replacing a defect fuse.

1. As it is usually unknown which fuse is defect, they should all be checked. The fuses are on the front side wall (looking from the front of the unit) of the power modules and are covered with a soft plastic cap.
2. Remove the soft plastic cap from the fuse to be tested and carefully pry out the fuse with a flat screwdriver.
3. Check whether the fuse is intact with a multi-meter, and if defective, replace with a similar type (size, rating, delay)
4. Repeat step 2 for all fuses.

Once all fuses have been checked and replaced, and if no other defect is apparent, the unit can be reassembled (Step 1 in reverse order)

5.7 Grounding Requirements



The unit is grounded via the AC Input. A line cord with proper Earth Ground must be used at all times. Correct grounding of your electrical system infrastructure according to applicable national standards must also be observed.

5.8 Rack Mounting

The DCS Series chassis is designed to be rack mounted in a standard 19 inch rack for system applications. Zero stacking with other DCS unit or test equipment is possible. The depth of the unit and its weight must be taken into account.

The mounting brackets provided to fix the unit in a 19" cabinet can be removed so that the unit can be operated on any flat surface as a desktop unit.

- Select the location for the unit so that the connection to the load is as short as possible.
- Leave sufficient space behind the equipment, minimum 30 cm/2.5ft, for ventilation

Acceptable and unacceptable installation positions are shown below:

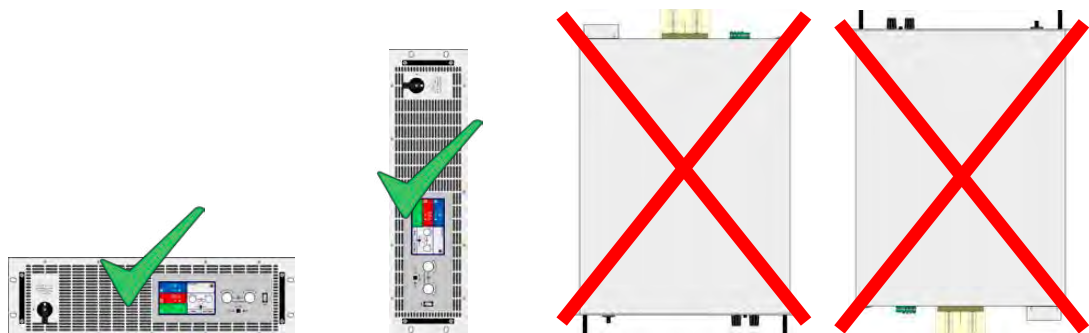

5.9 Bench Use

The handles on the front are for sliding in and out of the cabinet. Slots on the front plate are provided for fixing the unit (rack-mount screws not included). The DCS Series chassis is not equipped with surface protection feet as it is intended primarily for 19" rack mount use. For use on the bench, use protective sheet to prevent damage to tabletop surfaces.

5.10 Loads Connections

5.10.1 Recommended Wire Size

The DC load output bus bars are located on the rear panel of the unit and not protected by any fuses. The cross section of the DC load connection cables are determined by the maximum current consumption, cable length and ambient temperature.

For cables up to 1.5 m/ 5 feet and average ambient temperature up to 50°C, the following wire sizes are recommend:

Max. Curr.	Wire Size	Max Curr.	Wire Size
30 A	6 mm ²	70 A	16 mm ²
90 A	25 mm ²	140 A	50 mm ²
170 A	70 mm ²	210 A	95 mm ²
340 A	2 x 70 mm ²	420 A	2 x 95 mm ²
510 A	2 x 120 mm ²	1000 A	3 x 185 mm ²

Table 5-2: DC Load Wire Size Table

These values apply per connection pole for multi-conductor, insulated and openly suspended – not inside conduit- cables. Single cables of, for example, 70 mm² may be replaced by e.g. 2x35 mm² etc. For longer cables, the cross section dimensions must be increased to avoid excessive voltage loss and overheating.

5.10.2 DC Terminal Types

The table below shows an overview of the various DC terminals. It is recommended that of load cables connection always use flexible cables with properly sized ring lugs.

3U Models

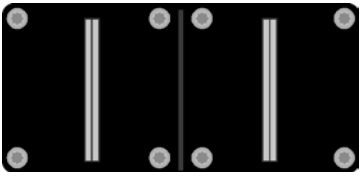
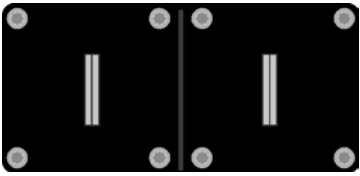
Type 1: Models up to 360 V output voltage	Type 2: Models from 500 V output voltage
	
M8 bolt on a metal rail Recommendation: ring lug with a 8 mm hole	M6 bolt on a metal rail Recommendation: ring lug with a 6 mm hole

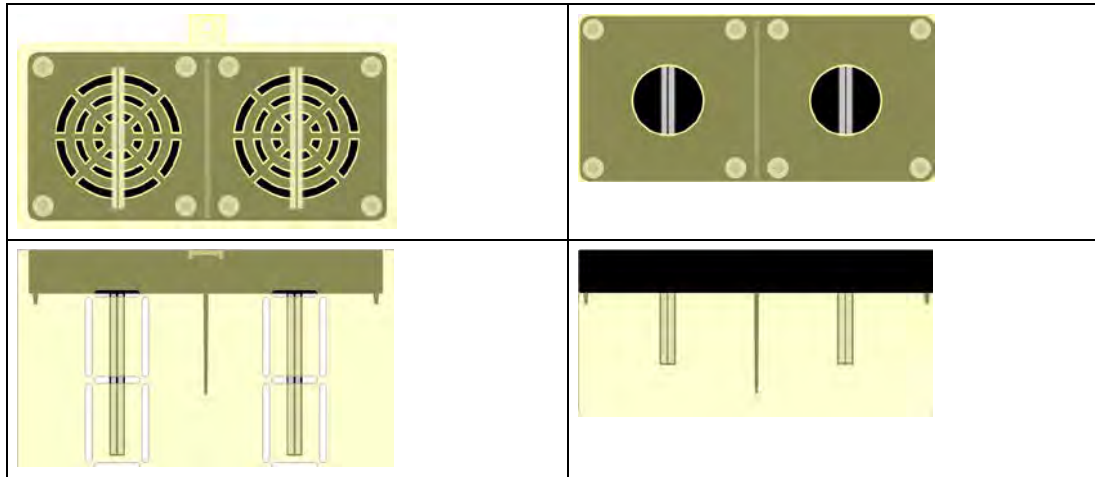

Figure 5-8: DC Terminal Types 1 & 2 for 3U Models

4U Models



Type 1: Models up to 200 V	Type 2: Models from 360 V
	
<p>M10 bolt on a metal rail Recommendation: ring lug with a 11 mm hole</p>	<p>M6 bolt on a metal rail Recommendation: ring lug with a 6.5 mm hole</p>
	

Figure 5-9: DC Terminal Types 1 & 2 for 4U Models

5.10.3 Output Cable Safety Covers

A plastic safety cover for contact protection is included for the DC terminals. This cover should always be installed. The cover for type 2 (see picture above) is fixed to the connector itself. The cover for type 1 attaches to the rear panel of the unit. The cover for type 1 has several breakouts so that the supply cable exit the cover in different directions.

The connection angle and the required bending radius for the DC cable must be taken into account when planning the depth of the complete unit + cabling, especially when installing in a 19" cabinet or similar. For type 2 connectors only a horizontal direction lead can be used to allow for installation of the safety cover.

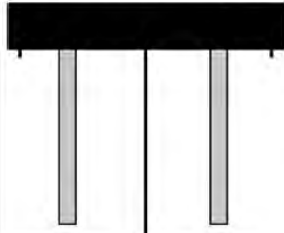
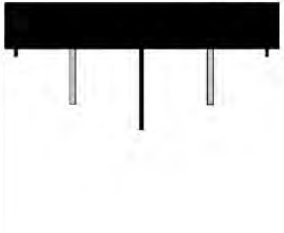
Examples of Type 1 terminal connections:

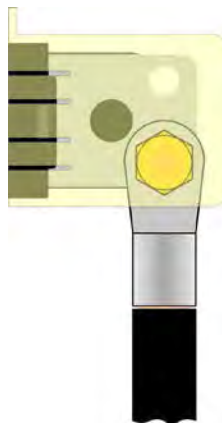

- 90° up or down
- Depth space savings
- No bending radius

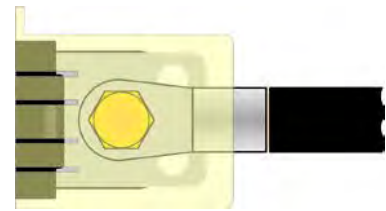

- Horizontal break-out
- Height space savings
- Bending radius required

5.10.4 DC Output Grounding

Regardless if the power supply is operated stand-alone or in series connection with others, it is always only permitted to ground **only one** of all the DC output poles. Following also has to be considered:

- Because of isolation, there is a maximum allowable potential shift of the DC output poles. This maximum potential depends on the power supply model. Refer to the Technical Specifications section for POS and NEG output to ground isolation levels.
- The DC minus pole of a stand-alone unit can be grounded right away, but it should only be done if absolutely necessary as the DC output is connected to PE via X capacitors in order to gain a better EMI filtering.
- Digital and analog interfaces are galvanically isolated from the DC output and should never be grounded but never when any of the DC output poles is grounded too, as this will cancel the galvanic isolation.
- When grounding one of the DC output poles, check if any pole of the load is already grounded. If so, this could lead to a short circuit condition!



5.10.5 Remote Voltage Sense Connections

To minimize voltage drop on the load cables to the unit under test, remote voltage sense connections are recommended. This is especially true for high current applications or in situations where the long cables are long. Voltage sense wires carry no load current so can be considerable smaller in diameter than load cables.

Remote sensing is only effective during constant voltage operation (CV). For other regulation modes, the external voltage sense inputs should be disconnected, if possible. Connecting them in non-CV mode generally increases the tendency of the output to oscillate.

- Use only the outer sense connector terminals marked + and -. The pins marked NC should **NOT** be used to ensure sufficient isolation clearance.

- The cross section of the sense cables is not critical. Recommendation for cables up to 5 m. is to at least 0.5 mm².
- Sense cables should be twisted and laid close to the DC cables to dampen oscillation. If necessary, an additional capacitor should be installed at the load terminal to eliminate any oscillation.
- The positive (+) sense cables must be connected to the positive terminal (+) on the load and negative (-) sense to the negative terminal (-) at the load, otherwise the sense input stage of the power supply can be damaged by the reversed polarity. See Figure 5-5 below for proper polarity.
- In master-slave configurations, the remote sensing should be connected to the **master unit only**.

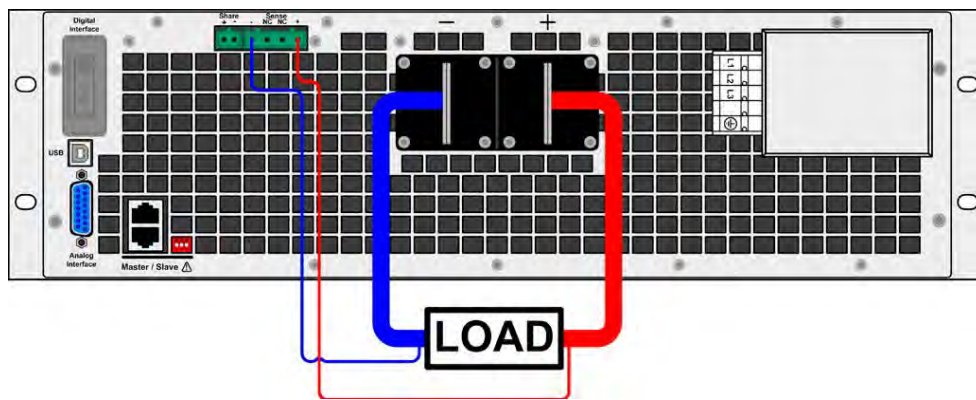

Figure 5-10: External Voltage Sense Connection – 3U Models

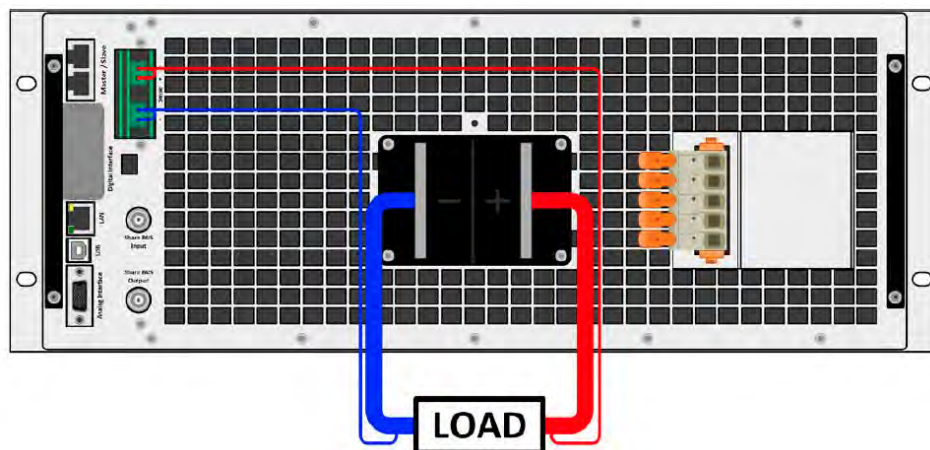

Figure 5-11: External Voltage Sense Connection – 4U Models



5.11 Analog Interface Connections

The 15 pole connector (Type: Sub-D, D-Sub) on the rear panel is an analog interface. To connect this interface to a controlling hardware (PC, PLC or other electronic circuit), a standard mating plug is necessary (not included in the ship kit). It is generally advisable to switch the unit completely off before connecting or disconnecting this connector, but at least the DC output.



Note: The analog interface is galvanically isolated from the unit internally. Therefore, do not connect any ground of the analog interface (AGND) to the DC minus output, as this will cancel the galvanic isolation.

5.12 Optional Interface Module Installation

5.12.1 Before Installation

The optional interface modules can be retrofitted by the user and are exchangeable with each other. The settings for the currently installed module vary and need to be checked and, if necessary, corrected on initial installation and after a module exchange.



- Common ESD protection procedures apply when inserting or exchanging a module.
- The unit must be switched off before insertion or removal of a module.
- Never insert any other hardware other than an interface module into the slot.
- If no module is in use it is recommended that the slot cover is mounted in order to avoid internal dust entering and affecting changes in the air flow.

5.12.2 Procedure

Use the images shown below for reference. To install or exchange an interface module, proceed as follows:

1. Remove the slot cover. If needed use a screwdriver.
2. Check that the attachment screws of an already installed module are fully retracted. If not, unscrew them (Torx 8) and remove the installed module.
3. Insert the new interface module into the slot. The shape ensures correct alignment.
4. When inserting, take care that it is held as close as possible to a 90° angle to the rear wall of the unit. Use the green PCB which you can recognize on the open slot as guide. At the end is a socket for the module.

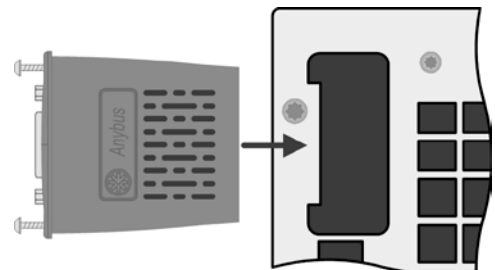
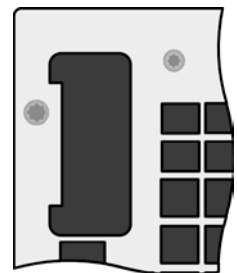

5. On the underside of the module are two plastic tabs, which must click into the green PCB so that the module is properly aligned on the rear panel of the unit.
6. The screws (Torx 8) are provided for fixing the module and should be fully screwed in. After installation, the module is ready for use and can be connected.

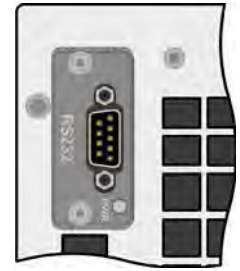

For removal, follow the reverse procedure. The screws can be used to assist in pulling out the module.

5.13 Share Bus Connections

The “Share” bus connector on the rear panel is intended to balance the current of multiple units in parallel operation, especially when using the integrated function generator of the master unit. Alternatively, it can be connected to a compatible electronic load like the 6RL Series, in order to create a two-quadrant source/sink system.

For the connection of the share bus, pay attention to the following issues:



- Connection is only permitted between compatible units (See section 3.7.4, “Share Connections” for details) and between a max. of 32 units
- If a two-quadrant system has to be set up where multiple power supplies are connected to one electronic load unit or a group of electronic loads, all units should be connected via the Share bus.
- When not using one or several units of a system configured with Share bus, because less power is required for an application, it is recommended to disconnect unused units from the Share bus, because even when not powered, they can have a negative impact on the control signal on the bus due to their impedance. Disconnection can be done by simply unplugging them from the bus or using external switches.
- The Share bus is referenced to the DC minus output terminal. When building a series connection system (where allowed, depending on model), the DC minus will shift its potential and thus so will the Share bus.

5.14 Slave Units

The 15 kW DCS Power supply models can be extended using slave units of the same voltage and power rating to extend power in a parallel system of up to 32 units in total. Other model configurations are not possible.

The slave units lack any display and feature a reduced control panel. They cannot be used stand-alone. They are configured solely to be used under remote control.

The parallel connection system uses master-slave operation and the Share bus. Slave units can be added incrementally as required. Every unit comes with a master-slave cable to

connect to the next unit. Cables for Share bus and DC output are not included and must be manufactured by the user.

When using 19" cabinets, there are DC bus bars available upon request, which are ready to be mounted directly to the DC output of the units. Since the number of bus bars and required screws varies depending on the maximum current you want to achieve, it is necessary to assemble individual sets. When planning to extend the system by further units, it is advised to order and install bus bars for the final configuration even when starting with just two units.

The configuration of the master unit is done either on the unit itself or via software in remote control. The slave units do not require any setup, as they are preconfigured to always be slaves on the master-slave bus

5.15 Firmware Update



Note: Firmware updates should only be installed when they can eliminate existing bugs in the firmware in the unit or contain new features.

The firmware of the front panel controller (HMI), the communication unit and the digital controller can be updated via the rear panel USB device port. For this the APS DCS Control software is required which is available as download from our website. Firmware image files are distributed through customer service.

However, be advised not to install updates casually. Each update includes inherent risk of an inoperable unit or system. We recommend to install updates only if:

- An imminent problem with your unit can directly be solved, especially if suggested by APS customer service to install an update because of a support case.
- A new feature has been added which you definitely need. In this case, the full responsibility for updating firmware is transferred to the unit owner.

Following considerations also apply to firmware updates:

- Simple changes in firmware can have crucial effects on the application the units are used in. We thus recommend to study the list of firmware changes in the revision history very thoroughly.
- Newly implemented features may require an updated documentation (user manual and/or programming guide, as well as LabView™ drivers), which are often available later, in some cases significantly later.

5.16 Cleaning

This unit needs no maintenance. Cleaning of the internal fans may be needed. The frequency of cleaning depends on the ambient conditions. The fans serve to cool the components, which are heated by normal internal power losses. Heavily dirt clogged fans can lead to insufficient airflow and therefore the DC output can switch off prematurely due to overheating. Defects can possibly result in this case.

Cleaning the internal fans can be performed with a vacuum cleaner or similar. To do so, the units needs to be opened

To clean the exterior of this unit uses a soft or slightly damp cloth.

CAUTION

BEFORE you clean the unit, switch the mains power off and disconnect the input line cord.

- **Please do NOT use any organic solvent capable of changing the nature of the plastic such as benzene or acetone.**
- **Please ensure that no liquid is allowed to penetrate this product.**

5.17 In Case of Malfunction

In the unlikely event of an instrument malfunction or if the instrument does not turn on despite the presence of the correct AC line voltage, please attach a warning tag to the instrument to identify the owner and indicate that service or repair is required. Contact Adaptive Power Systems or its authorized representative to arrange for service.

6 Front Panel Operation

This Chapter provides an overview of front panel operation for the DCS Series DC power supplies. For remote control operation, refer to Section 7 “Remote Control Programming” of this manual for an overview of available programming commands.

6.1 Front Panel Layout

The front panel layout is shown in Figure 6-1 below. The number of controls is kept to a minimum to ensure simple front panel operation for casual and experienced users alike. The two shuttle knobs are used to slew parameter values and move through menus as needed to make selections. All other operations and settings are controlled through the large touch sensitive LCD display.



Figure 6-1: DCS Series Front Panel View

The following control elements are available on the front panel:

(1)	Touchscreen display Used for selection of set values, menus and settings, as well as display of actual values and status. The touchscreen can be operated with the fingers or with a stylus.
(2)	Rotary knob with push button function Left knob (turn): adjusting the voltage, power or resistance set values, or setting the parameter values in the menu. Left knob (push): selection of the decimal position to be changed (cursor) in the current value selection. Right knob (turn): adjusting the current set value, or setting parameter values in the menu. Right knob (push): selection of the decimal position to be changed (cursor) in the current value selection.
(3)	On/Off Button for DC input Used to toggle the DC output on and off, also used to start a function run. The LEDs “On” and “Off” indicate the state of the DC output, no matter if the device is manually controlled or remotely
(4)	USB-A port For the connection of standard USB thumb drives.

The power ON/OFF switch is found in the lower center of the front panel between the two shuttle knobs. A USB memory stick port is located on the right hand side.

6.2 Touch Screen Display

The graphic touchscreen display is divided into a number of areas. The complete display is touch sensitive and can be operated by finger or stylus to control the equipment.

In normal operation the left hand side displays output read back values and set values and the right hand side displays status information:

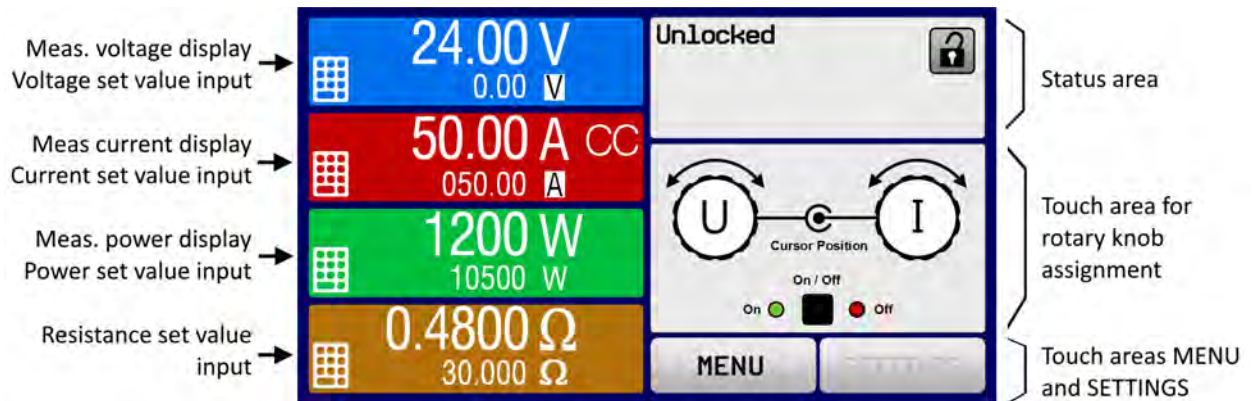

Note that touch areas may be enabled or disabled:

- Black text or symbol = Enabled
- Grey text or symbol = Disabled



This applies to all touch areas on the main screen and all menu pages.

The 4U models have a modernized graphics display style but operate the same way as the 3U models.



6.2.1 Settings

In normal operation, the DC output values (large numbers) and set values (small numbers) for voltage, current and power are displayed. Resistance set value of the variable internal resistance is only displayed when in active resistance mode.

When the DC output is turned on, the actual regulation mode, **CV**, **CC**, **CP** or **CR** is displayed next to the corresponding actual values, as shown in the figure above.

The set values can be adjusted with the rotary knobs next to the display screen or can be entered directly via the touchscreen. When adjusting with the knobs, pushing the knob will select the digit to be changed and thus the programming resolution. The set values are increased by clockwise turning and decreased by anti-clockwise turning.



6.2.2 General display and setting ranges:

Display	Unit	Range	Description
Actual voltage	V	0-125% U_{Nom}	Actual values of DC output voltage
Set value of voltage ¹	V	0-102% U_{Nom}	Set value for limiting the DC output voltage
Actual current	A	0.2-125% I_{Nom}	Actual value of DC output current
Set value of current ¹	A	0-102% I_{Nom}	Set value for limiting the DC output current
Actual power	W, kW	0-125% P_{Nom}	Actual value of output power, $P = U * I$
Set value of power ¹	W, kW	0-102% P_{Nom}	Set value for limiting DC output power
Set value of internal resistance ¹	Ω	0-100% R_{Max}	Set value for the simulated internal resistance
Adjustment limits	ditto	0-102% nom	U-max, I-min etc., related to the physical values
Protection settings	ditto	0-110% nom	OVP, OCP etc., related to the physical values

6.2.3 Status Display

Display	Description
Locked	The touch interface is locked
Unlocked	The touch interface is unlocked
Remote:	The unit is under remote control from....
Analogthe built-in analog interface
USB & othersthe built-in USB port or a plug in interface module
Local	The unit has been locked by the user explicitly against remote control
Alarm:	Alarm condition which has not been acknowledged or still exists.
Event:	A user defined event has occurred which is not yet acknowledged.
Master	Master-slave mode activated, unit is a master

¹ Valid for values related to these physical quantities, such as OVD for voltage and UCD for current.

Slave	Master-slave mode activated, unit is a slave
Function:	Function generator activated, function loaded
Stopped / Running	Status of the function generator resp. of the function
 / 	Data logging to USB stick active or failed

6.2.4 Rotary Knob Assignments

The two rotary knobs next to the display screen can be assigned to various functions. This area shows the actual assignments. These can be changed by tapping this area, as long as it's not locked. The display changes to:

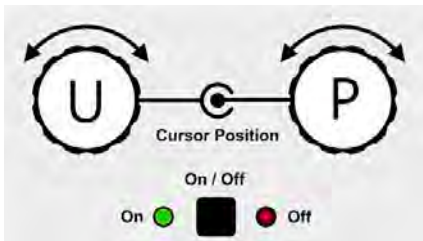

The physical quantities on the depiction of the knob shows the current assignment. The left knob is always assigned to the voltage U, while the right knob can be switched by tapping the knob.

The area will then show one of the following the assignments:

U I	U P	U R
Left knob: Voltage	Left knob: Voltage	Left knob: Voltage
Right knob: Current	Right knob: Power	Right knob: Resistance

The other set values can't be adjusted via the rotary knobs, unless the assignment is changed. However, values can be entered directly with a ten-key pad by tapping on the small keypad icon in each set value area. Alternatively to the knob depiction, the assignment can also be changed by tapping the colored set value areas for each set value area.

6.2.5 Rotary Knob Operation



As long as the unit is in manual operation mode, the two rotary knobs are used to adjust set values as well as setting any of the parameters located in the SETTINGS and MENU screens. For a detailed description of the individual functions see section 6.4.

Both knob also have a push-button function. This function may be used to change the cursor position in the set value to a different digit to change the adjustment value for the parameter being changed. This is illustrated here:



6.2.6 Available resolutions by voltage models:

Voltage, OVP, UVD, OVD, U-min, U-max			Current, OCP, UCD, OCD, I- min, I-max			Power, OPP, OPD, P-max			Resistance, R-max		
Nom.	Digits	Incr.	Nom.	Digits	Incr.	Nom.	Dig its	Incr.	Nom.	Digits	Incr.
80V	4	0.01V	20A	5	0.001A	<6.6kW	4	1W	< 7Ω	5	0.0001 Ω

Voltage, OVP, UVD, OVD, U-min, U-max			Current, OCP, UCD, OCD, I- min, I-max			Power, OPP, OPD, P-max			Resistance, R-max		
200V	5	0.01V	30-90A	4	0.01A	>10kW	5	1W	14-90Ω	5	0.001Ω
360V	4	0.1V	120-210A	5	0.01A	M/S <10kW	3	0.1kW	135-526Ω	5	0.01Ω
500V	4	0.1V	>340A	4	0.1A	M/S <100kW	4	0.01kW	>1000Ω	5	0.1Ω
750V	4	0.1V	M/S > 1000A	4	1A	M/S > 100kW		0.1kW			
1000V	5	0.1V									
1500V	5	0.1V									

6.3 Front Panel USB Port

The frontal USB port, located to the right of the rotary knobs is intended for the connection of a standard USB memory stick and can be used for loading or saving sequences for the arbitrary and the XY generator.

USB 2.0 sticks are accepted and must be FAT32 formatted and have a maximum capacity of 32GB. USB 3.0 sticks also work, but not from all manufacturers. All supported files must be held in a designated folder in the root path of the USB drive in order to be found. This folder must be named HMI_FILES, such that a PC will recognize the path G:\HMI_FILES if the drive were to be assigned the letter G.

The control panel of the unit can read the following file types from USB memory:

File Type	Description
wave_u<your_text>.csv wave_i<your_text>.csv	Function generator for an arbitrary function on voltage (U) or current (I) The name must begin with <i>wave_u</i> / <i>wave_i</i> , the rest is user defined.
iu<your_text>.csv ui<your_text>.csv	IU or UI table for the XY function generator. The name must begin with <i>iu</i> or <i>ui</i> , the rest can be user defined.
pv<your_text>.csv fc<your_text>.csv	PV or FC table for the XY function generator. The name must begin with <i>pv</i> or <i>fc</i> , the rest can be user defined.
pv_day_et_<your_text>.csv pv_day_ui_<your_text>.csv	Day trend data file to load for the simulation modes DAY I/T and DAY U/I of the extended PV function. See section 7.12.17.2 on page 186 for details.

Table 6-1: USB Memory File Types for Loading

The control panel of the unit can save the following file types to USB memory:

File Type	Description
usb_log_<nr>.csv	File with log data recorded during normal operation in all modes. The file layout is identical to the those generated from the Logging feature in Windows control software. The <nr> field in the file name is automatically counted up if equally named files already exist in the folder.
profile_<nr>.csv	Saved user profile. The number in the file name is a counter and not related to the actual user profile number in the front panel. A max. of 10 files to select from is shown when loading a user profile.
pv<nr>.csv	PF function table data, as calculated by the unit. Can be loaded again.
fc<nr>.csv	FC function table data, as calculated by the unit. Can be loaded again.
wave_u<nr>.csv wave_i<nr>.csv	Set point data (here: sequences) from arbitrary function generator of either voltage U or current I
pv_record_<nr>.csv	Data from the data recording option in the extended PV function according to

Table 6-2: USB Memory File Types for saving

6.4 Manual Operation

6.4.1 Turn On the Power Supply

The power supply must be turned on using the rotary switch on the front of the unit. Alternatively, turn on can be accomplished using an external device (contactor, circuit breaker) of suitable voltage and current rating.

After power on, the display will first show some unit related information (model, firmware versions etc.) and then a language selection screen for 3 seconds. After a few more seconds, it will display the main screen.

The condition of the DC output after power-up can be configured in setup mode (see section 6.4.3, “MENU System Overview” on page 81) in the second level menu “General settings”. Use the “Output after power ON” setting to determine the output state. Factory setting is “OFF”, meaning that the DC output after power-up is always switched off. “Restore” means that the last condition of the DC output will be restored, either on or off. All set values are always saved and restored.

Note: During the start-up phase at power on, the analog interface can signal undefined states on its output pins such as ERROR or OVP. Those signal states should be ignored until the unit has finished booting up completely and is ready for use.

6.4.2 Turn Off the Power Supply

On power off, the last output condition and the active setting values are automatically saved. Furthermore, a PF alarm (Power Failure) will be reported, but can be ignored.

The DC output is immediately switched off and after a short period, the internal fans will shut down. After another few seconds the unit will be completely powered off.

6.4.3 MENU System Overview

The MENU screen is used to configure all operating parameters, which are not required on a regular basis. These can be set by touch on the MENU touch area, but only if the DC output is switched OFF. See figure to the right.

If the DC output is switched **ON** the settings menu will not be shown, only status information.

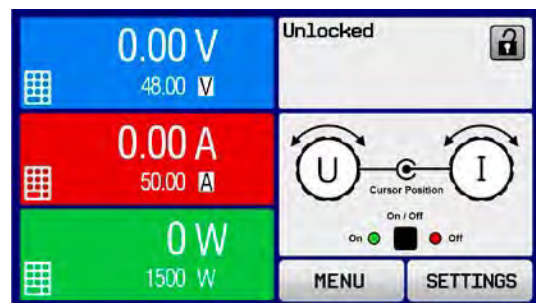

Menu navigation is by touch only. Individual values are set using the rotary knobs. The assignment of the knobs to the adjustable values is not visible in menu pages, but there is a standard assignment order rule:

Upper value -> Left-hand knob, Lower values -> Right-hand knob.

The menu structure is shown on the following pages. Some setting parameters are self-explanatory, others are not. The latter will be explained on subsequent pages.

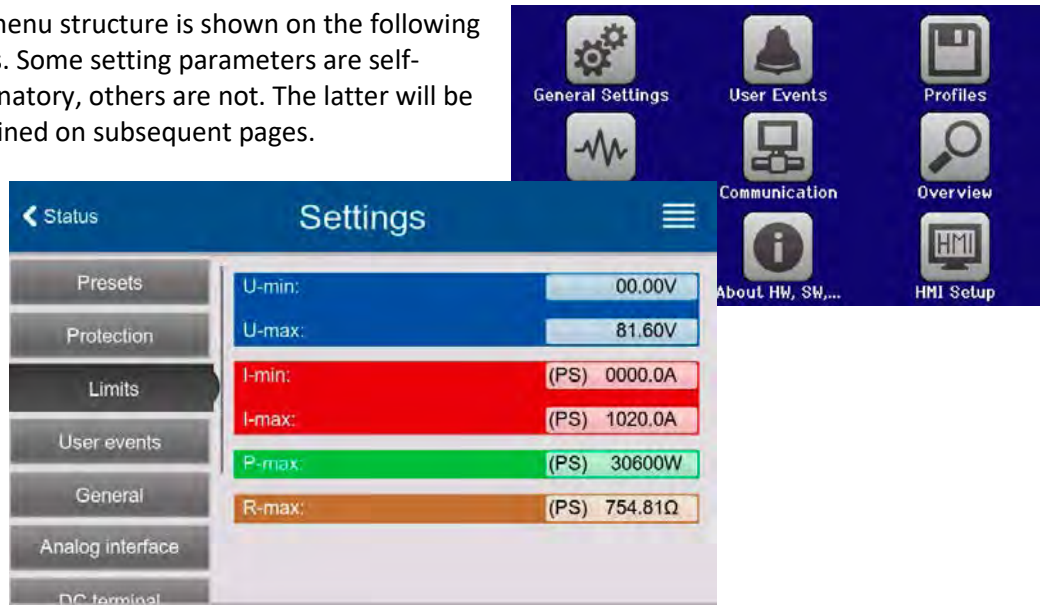

6.4.3.1 Menu Structure Overview Charts

Shown on following three pages.

MENU	General Settings	Page 1	Allow remote control: <u>YES</u> NO	
	User Events		Analog Interface range: 0..5V <u>0..10V</u>	
	Profiles	Default Profile	Page 2	Analog Interface Rem-SB: <u>Normal</u> Inverted
		User Profile 1		Analog Rem-SB action: <u>DC OFF</u> DC ON/OFF
	Overview	User Profile 2	Page 3	DC output after power ON: <u>OFF</u> Restore
	About HW, SW...	User Profile 3	Page 4	DC output after PF alarm: <u>OFF</u> AUTO
		User Profile 4		DC output after remote: <u>OFF</u> AUTO
		User Profile 5	Page 5	Enable R mode: Yes <u>No</u>
			Page 6	USB decimal point format: US <u>Default</u>
				USB logging with units (V,A,W): <u>Yes</u> No
		Page 7	Calibrate Unit: Start	
		Page 8	Reset unit to defaults: Start	
			Restart unit: Restart	
		Page 9	Master-Slave mode: <u>OFF</u> MASTER SLAVE	
		Page 10	Repeat master init.: Initialize	
		Event U	UVD = {0V...Unom} - Action = { <u>NO</u> SIGNAL WARNING ALARM}	
			OVD = {0V...Unom} - Action = {NO SIGNAL WARNING ALARM}	
		Event I	UCD = {0A...Inom} - Action = {NO SIGNAL WARNING ALARM}	
			OCD = {0A...Inom} - Action = {NO SIGNAL WARNING ALARM}	
		Event P	OPD = {0W...Pnom} -Action = {NO SIGNAL WARNING ALARM}	

Note: Parameters in curly brackets describe the selectable range, underlined parameters show the default value after delivery or reset.

MENU

Function Generator	Sine		U	$U(A) = 0V \dots U_{max} - \text{Offset}$	
	Triangle		I	$U(\text{Off}) = U(A) \dots U_{max} - U(A)$	
	Rectangle			$f(1/T) = 1\text{Hz} \dots 10000\text{Hz}$	
	Trapezoid		U	$U(A) = 0V \dots U_{max} - \text{Offset}$	
	DIN 40839	DIN Sequence 1	$U_{start} = 0V \dots U_{max}$	I	$U(\text{Off}) = U(A) \dots U_{max} - U(A)$
		DIN Sequence 2	$U_{end} = 0V \dots U_{max}$		$t1 = 0.1\text{ms} \dots 36000\text{s} (1\text{ms})$
		DIN Sequence 3	$\text{Seq.time} = 0.1\text{ms} \dots 36000\text{s}$		$t2 = 0.1\text{ms} \dots 36000\text{s} (1\text{ms})$
		DIN Sequence 4	$U(\text{Start/End}) = 0V \dots U_{max}$	U	$U(A) = 0V \dots U_{max} - \text{Offset}$
		DIN Sequence 5	$I(\text{Limit}) = 0A \dots I_{max}$	I	$U(\text{Off}) = U(A) \dots U_{max} - U(A)$
		DIN Sequence 6	$P(\text{Limit}) = 0W \dots P_{max}$		$t1 = 0.1\text{ms} \dots 36000\text{s} (1\text{ms})$
		DIN Repetition	$\text{Seq.cycles} = , 0 \dots 999$		$t2 = 0.1\text{ms} \dots 36000\text{s} (1\text{ms})$
				$t3 = 0.1\text{ms} \dots 36000\text{s} (1\text{ms})$	
				$t4 = 0.1\text{ms} \dots 36000\text{s} (1\text{ms})$	
	Ramp		U	$U_{start} = 0V \dots U_{max}$	
	Arbitrary	Settings 1	$U_s(AC) = 0V \dots U_{max}$	I	$U_{end} = 0V \dots U_{max}$
$U_e(AC) = 0V \dots U_{max}$				$t1 = 0.1\text{ms} \dots 36000\text{s} (1\text{ms})$	
$f_s(1/T) = 0\text{Hz} \dots 10000\text{Hz}$				$t2 = 0.1\text{ms} \dots 36000\text{s} (1\text{ms})$	
$f_e(1/T) = 0\text{Hz} \dots 10000\text{Hz}$				$U_s(DC) = 0V \dots U_{max}$	
Settings 2		$\text{Angle} = 0^\circ \dots 359^\circ$		$U_e(DC) = 0V \dots U_{max}$	
			$\text{Seq.time} = 1\text{ms} \dots 36000\text{s}$		
XY	UI Table	I/P Limits / U/P Limits			
	U Table	Load from USB			
	PV Table	Calc. PV Table		Save to USB	
	FC Table	Calc. FC Table		Save to USB	

Note: Parameters in curly brackets describe the selectable range, underlined parameters show the default value after delivery or reset.

MENU

Communication	<interface_name>
	Com Timeout	Timeout USB/RS232 (ms): <u>5</u> ...65535
		Timeout ETH (s): <u>5</u> ...65535
	Com Protocols	SCPI: <input checked="" type="checkbox"/>
		ModBus: <input checked="" type="checkbox"/>

HMI Setup	Language	English, Deutsch, Русский, 中文	
	Backlight	Always on: <input type="checkbox"/>	Off after 60 sec: <input type="checkbox"/>
		Brightness:	
	HMI Lock	Lock all: <input type="checkbox"/>	ON/OFF possible: <input type="checkbox"/>
			Enable PIN: <input type="checkbox"/>
			Change user PIN: Start
	Key Sound	Sound on	<u>Sound off</u>
	Alarm Sound	Sound on	<u>Sound off</u>
	Status page		Show meter bar: <input type="checkbox"/>
			Alternate status page: <input type="checkbox"/>
Limits Lock		Lock: <input type="checkbox"/>	
		Unlock: Start	

6.4.3.2 General Settings Menu

Setting	Description
Allow remote control	Selection “NO” means that the unit cannot be remotely controlled over either the digital or analog interfaces. If remote control is not allowed, the status will be shown as “local” in the status area on the main display.
Analog interface range	Selects the voltage range for the analog set inputs, actual value outputs and reference voltage output. <ul style="list-style-type: none"> • 0...5 V = Range is 0...100% set /actual values, reference voltage 5 V • 0...10 V = Range is 0...100% set /actual values, reference voltage 10 V. See section 6.7.3.
Analog interface Rem-SB	Selects how the input pin “Rem-SB” of the analog interface shall be working regarding levels (see “Analog interface specification”) and logic: <ul style="list-style-type: none"> • normal = Levels and function as described in the table in section 6.7.3.4. • inverted = Levels and function will be inverted. Also see “Application examples”
Analog Rem-SB action	Selects the action on the DC output that is initiated when changing the level of analog input “Rem-SB”: <ul style="list-style-type: none"> • DC OFF = the pin can only be used to switch the DC output off. • DC AUTO = the pin can be used to switch the DC output off and on again, if it has been switched on before at least from a different control location.
Analog interface, pin 6	Pin 6 of the analog interface is by default assigned to only signal the device alarms OT and PF. This parameter allows to also enable signaling only one of both (3 possible combinations): <p>Alarm OT = Enable/disable signaling of alarm OT on pin 6</p> <p>Alarm PF = Enable/disable signaling of alarm PF on pin 6</p>
Analog interface, pin 14	Pin 14 of the analog interface is by default assigned to only signal the device alarm OVP. This parameter allows to also enable signaling further device alarms (7 possible combinations): <p>Alarm OVP = Enable/disable signaling of alarm OVP on pin 14</p> <p>Alarm OCP = Enable/disable signaling of alarm OCP on pin 14</p> <p>Alarm OPP = Enable/disable signaling of alarm OPP on pin 14</p>
Analog interface, pin 15	Pin 15 of the analog interface (see section 3.5.4.4) is by default assigned to only signal the regulation mode CV. This parameter allows to enable signaling a different device status (2 options): <p>Regulation mode = Enable/disable signaling of CV reg mode on pin 15</p> <p>DC status = Enable/disable signaling of DC terminal status on pin 15</p>
DC output after OT alarm	Determines how the DC power stages shall react after an overtemperature (OT) alarm has occurred and the power stages have cooled down again: <p>OFF = DC power stage(s) will be off.</p> <p>AUTO = The device will automatically restore the situation before the OT alarm, which usually means the DC power stage(s) to be on.</p>
DC output after power ON	Determines the condition of the DC output after power-up. <ul style="list-style-type: none"> • OFF = DC output is always off after switching on the unit. • Restore = DC output condition will be restored to the condition prior to switch off.
DC output after PF alarm	Determines how the DC output shall react after a power fail (PF) alarm has occurred: <ul style="list-style-type: none"> • OFF = DC output will be switched off and remain until user action • Auto ON = DC output will switch on again after the PF alarm cause is gone and if it was switched on before the alarm occurred
DC output after remote	Determines the condition of the DC output after leaving remote control either manually or by command. <ul style="list-style-type: none"> • OFF = DC output will be always off when switching from remote to manual • AUTO = DC output will keep the last condition
Enable R mode	Activates (“Yes”) or deactivates (“No”) the internal resistance control. If activated, the resistance set value can be adjusted on the main screen as additional value. For details, refer to section 3.4.4, “Internal Resistance (IR) Mode”.

Setting	Description
USB decimal point format	Switches the decimal point format of values and also the CSV file separator for USB logging and for other features where CSV file can be loaded US = Comma separator (US standard for CSV files) Default = Semicolon separator (European standard for CSV files)
USB logging with units (V,A,W)	CSV files generated from USB logging by default add physical units to values. This can be deactivated by setting this option to “ No ”
Calibrate unit	Touch area “ Start ” starts a calibration routine (see Calibration Section), but only if the unit is in U/I or U/P mode.
Reset unit to defaults	Touch area “ Start ” will initiate a reset of all settings (HMI, profile etc.) to factory default.
Restart unit	Will initiate a warm start of the unit
Master-slave mode	Selecting “ MASTER ” or “ SLAVE ” enables the master-slave mode (MS) and sets the selected position for the unit in the MS system. Default setting: OFF . This applies to the digital MS bus, the analog Share bus and two-quadrants operation. For details, see section 8, “Master/Slave (M/S) Operation” on page 220.
DCS/6RL System	Only displayed if the device has been set to MASTER When activated by finger touch (check mark), it determines that the power supply is part of a two-quadrant operation (see section 8, “Master/Slave (M/S) Operation” on page 220) system and thus it will be master on the Share bus, which is required for a 2QO system, because in that mode the power supply unit has to be master.
Repeat Master Init.	Touch area “ Initialize ” will repeat the initialization of the master-slave system in case the automatic enumeration of the slave units by the master is once unsuccessful so the system would have less total power than expected or has to be repeated manually in case the master unit couldn’t detect a missing slave

6.4.3.3 User Events Menu





Monitoring functions of the unit can be configured for user-defined events. By default, events are deactivated (action = NONE). Contrary to unit alarms, these events only work while the DC output is switched on. This means for example that you cannot detect under voltage (UVD) after switching the DC output off and the voltage is still decaying.

The following events can be configured independently and can, in each case, trigger the actions NONE, SIGNAL, WARNING or ALARM.

Event	Meaning	Description	Range
UVD	UnderVoltage Detection	Triggers an event if the output voltage falls below the defined threshold.	0 V...U _{Nom}
OVD	OverVoltage Detection	Triggers an event if the output voltage exceeds the defined threshold.	0 V...U _{Nom}
UCD	UnderCurrent Detection	Triggers an event if the output current falls below the defined threshold.	0 A...I _{Nom}
OCD	OverCurrent Detection	Triggers an event if the output current exceeds the defined threshold.	0 A...I _{Nom}
OPD	OverPower Detection	Triggers an event if the output power exceeds the defined threshold.	0 W...P _{Nom}

Note: These events should not be confused with alarms such as OT and OVP which are for unit protection. User defined events can, however, if set to action ALARM, switch off the DC output and thus protect the load, like a sensitive electronic application.

How to configure user defined events:

1. While the DC output is switched off tap the touch area  on the main screen.
2. On the right side tap the arrows   to select “4.1 Event U” or “4.2 Event I” or “4.3 Event P”.
3. Set the monitoring limits with the left hand rotary knob and the triggered action with the right hand knob relevant to the application (also see 6.6.1, “Definition of Terms” on page 109).
4. Accept the settings with .

Note: User events are an integral part of the actual user profile. Thus, if another user profile or the default profile is selected and used, the events could either be differently configured or not at all.

Note: The set values can be entered using the ten-key tab. This will appear by tapping the touch area “Direct input”.

6.4.3.4 Profiles Menu

The “Profiles” menu serves to select between a default profile and up to five user profiles. A profile is a collection of all settings and set values. Upon delivery, or after a reset, all six profiles have the same settings and all set values are zero. If the user changes settings or sets target values then these create a working profile, which can be saved to one of the five user profiles. These profiles or the default one can then be switched. The default profile is read-only.

The purpose of a profile is to load a set of set values, settings limits and monitoring thresholds quickly without having to readjust these. As all front panel settings are saved in the profile, including language, a profile change can also be accompanied by a change in language.

On calling up the menu page and selecting a profile, the most important settings can be seen, but not changed.

How to save the current values and settings as a user profile:

1. Tap the touch area  or  on the main screen
2. In the menu page, tap .

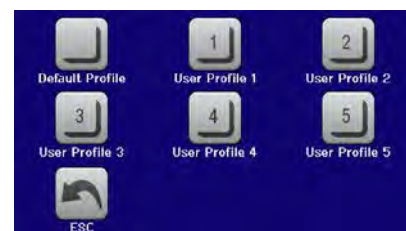

- In the selection screen (right) choose between user profile 1-5 in which the settings are to be saved. The profile will then be displayed and the values can be checked, but not changed.



- Save using the touch area **SAVE** or **Save/Load** and save the settings into the popup requester with **Save**.

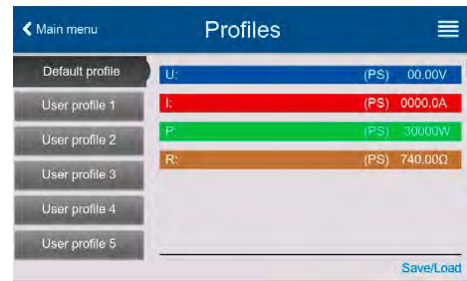

Note: All user profiles also allow to just edit some settings or values stored in the profile. When doing so, the changes either need to be saved to the profile with Save changes or discarded with Cancel before the profile can be loaded.

Loading a user profile works the same way, but in the requester you would then tap **Load** under Load profile?

Alternatively, you may import the profile or export it as file to an USB stick with **USB Import/Export**.

6.4.3.5 Overview Menu

This menu page displays an overview of the set values (U, I, P or U, I, P, R) and alarm settings as well as settings limits. These can only be displayed, not changed.

6.4.3.6 About Menu

This menu page displays an overview of relevant instrument data such as serial number, part number etc. It also contains an alarm history, which lists the number of unit alarms that occurred since the unit was last powered on.

6.4.3.7 Function Generator Menu

Refer to section 6.9, “Function Generator Use” on page 113 for details on using the function generator.

6.4.3.8 Communication Menu

This menu offers settings for digital communication via the optional or built-in interface. The touch button for the installed interface module or opens one or more settings pages, depending on the interface in use. There is also an adjustable communication timeout to support successful transfer of fragmented messages (data packets) using higher values. In the screen for “Com Protocols” you can enable both or disable one of the two supported communication protocols, ModBus and SCPI. This can help to prevent mixing protocols and receive unreadable messages, for example when expecting a SCPI response and getting a ModBus RTU response instead.

Note: For all Ethernet interfaces with two ports: “P1” is related to port 1 and “P2” to port 2, like printed on the module face. Two-port interfaces will use one IP only.

Setting for the various available digital interfaces are shown on the tables below.

IF	Level 1	Description
Profibus DP	Node Address	Selection of the Profibus or node address of the unit within range 1...125 via direct input
	Function Tag	String input box for a user-definable text, which describes the Profibus slave function tag. Max. length: 32 characters
	Location Tag	String input box for a user-definable text, which describes the Profibus slave location tag. Max. length: 22 characters
	Installation Date	String input box for a user-definable text, which describes the Profibus slave installation date tag. Max. length: 40 characters
	Description	String input box for a user-definable text, which describes the Profibus slave. Max. length: 54 characters

IF	Level 1	Description
RS232		The baud rate is selectable, other serial settings can't be changed and are defined like this: 8 data bits, 1 stop bit, parity = none Baud rates: 2400, 4800, 9600, 19200, 38400, 57600, 115200

IF	Level 1	Description
GPIB	Node Address	Adjustment of the GPIB node address (only with option GPIB installed). Allowable range is 1~30

IF	Level 1	Level 2	Level 3	Description
Ethernet / ModBus-TCP, 1 & 2 Port	IP Settings 1	DHCP		The IF allows a DHCP server to allocate an IP address, a subnet mask and a gateway. If no DHCP server is in the network then network parameters will be set as defined in item "Manual"
		Manual	IP address	This option is activated by default. An IP address can be manually allocated.
			Gateway	Here a gateway address can be allocated if required..
			Subnet mask	Here a subnet mask can be defined if the default subnet mask is not suitable.
		DNS address 1 DNS address 2	Here the addresses of the first and second Domain Name Servers (DNS) can be defined, if needed.	
		Port	Range: 0...65535. Default ports: 5025 = Modbus RTU (all Ethernet interfaces) Reserved ports which must not be set with this parameter: 502 = Modbus TCP (Modbus-TCP interface only) other typical reserved ports	
	IP Com Settings P1 IP Com Settings P2	AUTO		Settings for the Ethernet port such as transmission speed are set automatically.
	Manual	Half duplex	Manual selection for transmission speed (10MBit/100MBit) and duplex mode (full/half). It is recommended to use the "AUTO" option and only revert to "Manual" if these parameters fail.	
		Full duplex		
		10MBit		
		100MBit		
	Host name			Free choice of host name (default: Client)
Domain name			Free choice of Domain (default: Workgroup)	
TCP Keep-Alive	Enable TCP keep-alive			

IF	Level 1	Level 2	Level 3	Description
----	---------	---------	---------	-------------

Profinet/IO, 1 & 2 Port	IP Settings	DHCP		The IF allows a DHCP server to allocate an IP address, a subnet mask and a gateway. If no DHCP server is in the network then network parameters will be set as defined in point "Manual"
		Manual	IP address	This option is activated by default. An IP address can be manually allocated.
			Gateway	Here a gateway address can be allocated if required..
			Subnet mask	Here a subnet mask can be defined if the default subnet mask is not suitable.
		DNS address 1 DNS address 2		Here the addresses of the first and second Domain Name Servers (DNS) can be defined, if needed.
	Host name		Free choice of host name (default: Client)	
	Domain name		Free choice of Domain (default: Workgroup)	
	Function Tag		String input box for a user-definable text, which describes the Profinet slave function tag. Max. length: 32 characters	
	Location Tag		String input box for a user-definable text, which describes the Profinet slave location tag. Max. length: 22 characters	
	Station Name		String input box for a user-definable text, which describes the Profinet station name. Max. length: 54 characters	
Description		String input box for a user-definable text, which describes the Profibus slave. Max. length: 54 characters		
Installation Date		String input box for a user-definable text, which describes the Profibus slave installation date tag. Max. length: 40 characters		

IF	Level 1	Level 2	Level 3	Description	
CAN	Base ID			Setup of the CAN base ID (11 Bit or 29 Bit, hex format). Default: 0h	
	Baud Rate			Setup of the CAN bus speed or baud rate in typical value between 10 kbps and 1Mbps. Default: 500 kbps	
	Termination			Activates or deactivates CAN bus termination with a built-in resistor. Default: OFF	
	Broadcast ID			Setup of the CAN broadcast ID (11 Bit or 29 Bit, hex format). De- fault: 7ffh	
	ID Format			Selection of the CAN ID format between Base (11 Bit ID, 0h...7ffh) and Extended (29 Bit, 0h...1fffffffh)	
	Cyclic Communication	Base ID Cyclic Read			Setup of the CAN base ID (11 Bit or 29 Bit, hex format) for cyclic read of up to 5 object groups (see “ Cyclic Read Timing ”). The unit will automatically send specific object data to the IDs defined with this setting. For more information, refer to the programming guide. Default: 100h
			Base ID Cyclic Send		Setup of the CAN base ID (11 Bit or 29 Bit, hex format) for cyclic send of the three set values for U, I and P along with status in one single message. For more information, refer to the programming guide. Default: 200h
		Cyclic Read Timing	Status		Activation/deactivation and time setting for the cyclic read of status to the adjusted “ Base ID Cyclic Read + 1 ” Range: 20...5000 ms. Default: 0 (deactivated)
			Actual val.		Activation/deactivation and time setting for the cyclic read of actual values to the adjusted “ Base ID Cyclic Read + 2 ” Range: 20...5000 ms. Default: 0 (deactivated)
			Set val.		Activation/deactivation and time setting for the cyclic read of set values of U & I to the adjusted “ Base ID Cyclic Read + 3 ” Range: 20...5000 ms. Default: 0 (deactivated)
			Limits 1		Activation/deactivation and time setting for the cyclic read of adjustment limits of P & R to the adjusted “ Base ID Cyclic Read + 4 ” Range: 20...5000 ms. Default: 0 (deactivated)
Limits 2		Activation/deactivation and time setting for the cyclic read of adjustment limits of P & R to the adjusted “ Base ID Cyclic Read + 4 ”			
Data Length			Determines the DLC (data length) of all messages sent from the unit. AUTO = length varies between 3 and 8 bytes, depending on object Always 8 Bytes = length is always 8, filled up with zeros		

IF	Level 1	Level 2	Description
CANopen	Node Address		Selection of the CANopen node address in the range 1...127
	Baud Rate	AUTO	Automatic detection of the bus baud rate.(speed)
		LSS	Automatically sets baud rate and node address
	Manual	Manual selection of the baud rate that is used by the CANopen interface. Possible selections: 10 kbps, 20 kbps, 50 kbps, 100 kbps, 125 kbps, 250 kbps, 500 kbps, 800 kbps, 1Mbps (1Mbps = 1 Mbit/s, 10 kbps = 10 kbit/s)	

Time out and protocol setting parameters:

Element	Description
Com Timeout	<p>Timeout USB/RS232 (in milliseconds) Default value: 5, Range: 5...65535 Defines the max. time between two subsequent bytes or blocks of a transferred message. For more information about the timeout, refer to the Remote Control Programming section.</p> <p>Timeout ETH (in seconds) Default value: 5, Range: 5...65535 Defines a timeout after which the unit would close the socket connection if there was no command communication between the controlling unit (PC, PLC etc.) and the unit for the adjusted time. The timeout is ineffective as long as option "TCP keep-alive" is enabled and the keep-alive network service is running.</p>
Com Protocols	Enables or disables SCPI or ModBus communication protocols for the unit. The change is immediately effective after submitting it with ENTER button. Only one of both can be disabled.
Logging	<p>Default setting: disabled: Enables/disables the "log to USB stick" feature. Once enabled, you can define the log interval (multiple steps, 500 ms ... 5 s) and the control method. For more refer to 6.4.10, "Saving data to USB Memory Device (Data Logging)" on page 98.</p>

6.4.3.9 HMI / Front Panel Menu

These settings refer exclusively to the front panel controls.





Element	Description
Language	Selection of the display language between German, English (default), Russian or Chinese
Backlight	The choice here is whether the backlight remains permanently on or if it should be switched off when no input via screen or rotary knob is made for 60 s. As soon as input is made, the backlight returns automatically. Furthermore, the backlight intensity can be adjusted here.
HMI Lock	Refer to section 6.7, "Front Panel Lockout" on page 112.
Limits Lock	Refer to section 6.8, "Limits Settings Lock" on page 113
Key Sound	Activates or deactivates sounds when touching a touch area in the display. This signals that the action has been accepted.
Alarm Sound	Activates or deactivates the additional acoustic signal of an alarm or user defined event, which has been set to "Action = ALARM". See section 6.6, "Alarms and Monitoring" on page 109.
Status page	<p>Enables/disables two display related options for the main screen with actual and set values:</p> <p>Show meter bar: in U/I/P mode, i.e. resistance mode not activated, a meter bar for 0-100% actual values of voltage, current and power is shown.</p> <p>Alternative status page: switches the main screen of the unit with its actual and set values of voltage, current, power and - if activated - resistance to a simpler display with only voltage and current, plus status.</p> <p>Default setting: both disabled</p>

6.4.4 Adjustment or User Limits

Defaults Adjustment or User Limits are 102% of full scale for all settable values (U, I, P, R). The full range may be hazardous in some cases, especially for protection of loads against overvoltage. Therefore upper and lower limits for current (I) and voltage (U) can be set separately, which then limit the range of the adjustable set values.

For power (P) and resistance (R) only upper value limits can be set.

How to configure the adjustment limits:

1. On the main screen, tap  to access the SETTINGS menu
2. Tap the   arrows to select “3. Limits”
3. In each case a pair of upper and lower limits for U/I or the upper limit for P/R are assigned to the rotary knobs and can be adjusted. Tap the selection area for another choice .
4. Accept the settings with .

Notes:



Adjustment limits are only effective on the related set values, no matter if using manual adjustment or remote control setting!

The set values can be entered directly using the ten-key pad. This appears when the touch area “Direct Input” is tapped (bottom center).

The adjustment limits are coupled to the set values. This means, that the upper limit may not be set lower than the corresponding set value. For example, if you wish to set the limit for the power set value (P-max) to 6000 W while the currently adjusted power set value is 8000 W, then the set value first would have to be reduced to 6000 W or less before you can adjust P-max down to 6000 W.

6.4.5 Changing Operating Modes

Manual operation of the power supply distinguishes between three operating modes, U/I and U/P and U/R. These are tied to set value inputs made using the rotary knobs or decimal keypad. This assignment must be changed if one of these set values is to be adjusted and is not currently accessible.

How to change the active operating mode:

1. Unless the unit is in remote control or the panel is locked, you switch the operation anytime. There are two options: either tap the depiction of the right-hand knob (see figure to the right) to change its assignment between I, P and R, which is displayed below the knob depiction, or;
2. You directly tap on the colored areas with the set values, like shown in the figure to the right. The unit next to the set

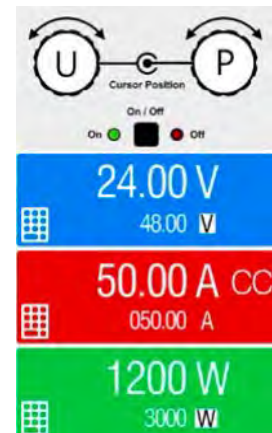

values, when inverted, indicates the assignment of the knob. In the example in the figure it has U and P assigned, which means U/P mode.

Depending on the selection, the right rotary knob will be assigned different set values. The left knob is always assigned to the voltage.

Note: In order to change the other values, like P or R while U/I is active, and without switching the assignment all the time, direct input can be used.

The actual operating mode, which is only indicated while the DC output is switched on, solely depends only on the set values.

6.4.6 Manual Adjustment of Set Values

The set values for voltage, current and power are the fundamental operating criteria of a power supply and hence the two rotary knobs on the front of the unit are always assigned to two of the values when in manual operation.

As fourth control value is the internal resistance setting, available only when the resistance mode (R mode) is activate.

Note: Set values can be entered manually in two ways: via rotary knob or direct input. Entering a value changes it immediately, regardless if the DC output is on or off.

When adjusting set values, upper or lower limits may come into effect. See section 6.4.4, “Adjustment or User Limits” on page 94”. Once a limit is reached, the display will show an indication like “Limit: U-max” etc. for about 1.5 seconds next to the adjusted value.

How to adjust set values U, I, P or R with the rotary knobs:

1. First check if the value you want to change is already assigned to one of the rotary knobs. The main screen displays the assignment as depicted in the figure to the right.
2. If, as shown in the example, the assignment is voltage (U, left) and power (P, right), and it is required to set the current, then the assignments can be changed by tapping this touch area. A set of selection fields then appears.
3. After successful selection, the desired value can be set within the defined limits. Selecting a digit is done by pushing the rotary knob, which shifts the cursor from right to left (selected digit will be underlined):

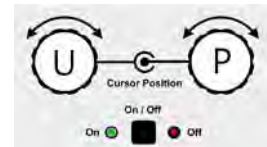



How to adjust values via direct input:

1. On the main screen, depending on the rotary knob assignment, values can be set for voltage (U), current (I), power (P) or resistance (R) via direct input by tapping on the set/actual value display areas, e.g. in the uppermost area of voltage.
2. Enter the required value using the decimal keypad.



Similar to a pocket calculator, the key  clears the input.

Decimal values are set by tapping the point key. For example, 54.3 V is set with



and

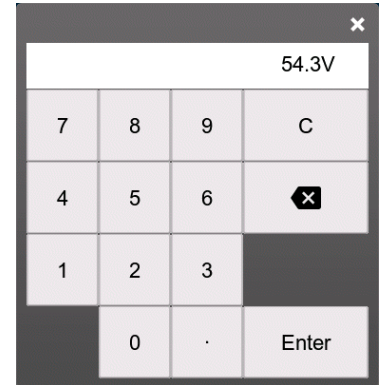

3. The display then switches back to the main page and the set values take effect

6.4.7 Switching the main screen view

The main screen, also referred to as status page, with its set values, actual values and unit status can be switched from the standard view mode with three or four values to a simpler view mode with only voltage and current display. The advantage of the alternative view mode is that actual values are displayed with much bigger characters, so they read be read from a larger distance. Refer to section 6.4.3.9, “HMI / Front Panel Menu” on page 93 to see where to switch the view mode in the MENU. Comparison:

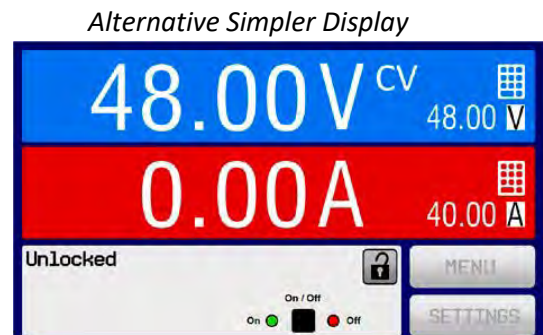
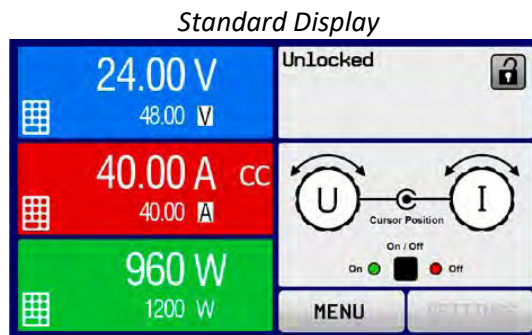

Limitations of the alternative display are:

- Set points and actual values of power are not displayed and the set value of power is only indirectly accessible
- The set value of resistance is not displayed and only indirectly accessible
- No access to the settings overview (MENU button) while the DC output is on

Note: In alternative status page mode, the set values of power and resistance are not adjustable while the DC output is switched on. They can only be accessed and adjusted in SETTINGS while the DC output is off.

Rules for manual control of the front panel in alternative display mode are:

- The two rotary knobs are assigned to voltage (left knob) and current (right knob) all the time, except for menus
- Set values input is the same as in standard status page mode, with knobs or by direct input
- Regulation modes CP and CR are displayed alternatively to CC at the same position

6.4.8 Metering / Read back Displays

In addition to the actual measured values being displayed as numbers, a meter bar graph for U, I and P can be enabled in the MENU screen. The meter bars remain hidden as long as resistance mode, i.e. U/I/R is activated. Refer to section 6.4.3.9, “HMI / Front Panel Menu” on page 93 to see how to enable the meter bars in the MENU. Depiction:

Standard Display with Metering Bars

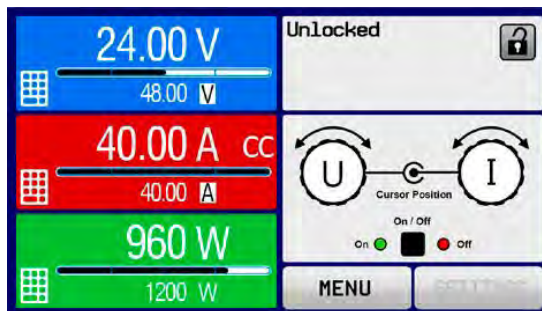

Alternative Display with Metering Bars



6.4.9 Turning Output DC ON or OFF

The DC output of the unit can be manually or remotely switched on and off. This can be restricted in manual operation by locking the front panel controls.

Note: Switching the DC output on during manual operation or digital remote control can be disabled by pin REM-SB of the built-in analog interface.

How to manually switch the DC output on or off:

1. As long as the control panel is not fully locked press the button ON/OFF. Otherwise you are asked to disable the HMI lock first.
2. This button toggles between on and off, so long as a change is not restricted by an alarm or the unit is locked in “remote”. The current condition is displayed on screen.

How to remotely switch the DC output on or off via the analog interface:

1. Refer to section 3.7, “Remote Control Interfaces” on page 24.

How to remotely switch the DC output on or off via the digital interface:

1. See the programming section if you are using custom software, or refer to the external documentation for the IDE software provided by the manufacturer.

6.4.10 Saving data to USB Memory Device (Data Logging)

Unit data can be recorded to USB memory devices. Revision 2.0 / 3.0 may work, but not all vendors are supported. For specifications of the USB stick and the generated log files refer to section 6.3, “Front Panel USB Port” on page 80.

The logging function stores files of CSV format on the memory stick. The layout of the log data is the same as when logging via PC with software GUI software. The advantage of USB logging over PC logging is the easy mobility of the data and that no PC is required. The logging feature just has to be activated and configured in the MENU.

6.4.10.1 Configuration 1



After USB logging has been enabled and the parameters “Logging interval” and “Start/ Stop” have been set, logging can be started anytime from within the MENU or after leaving it, depending on the selected start/stop mode.



6.4.10.2 Configuration 2

There are additional settings for the CSV file as generated by the USB logging function. You can switch the column separator format between European standard (“Default”) and US American standard (“US”). The other option is used to deactivate the physical unit that is added by default to every values in the log file. Deactivating this option simplifies the CSV file processing in MS Excel.

6.4.10.3 Handling (start/stop)

With setting “**Start/stop with DC output ON/OFF**” logging will start each time the DC output of the unit is switched on, either manually with the front “**On/Off**” button or remotely via the analog or digital interface. In setting “**Manual start/stop**” logging is started and stopped from the MENU screen on the logging configuration page.

Button  start logging manually and changes to  which is manual stop.

As soon as logging has been started, the disk symbol () indicates the ongoing logging action. In case there is an error while logging, such as when the USB memory is full or removed, a disk error symbol () will appear. After every manual stop or switching OFF the DC output, the logging is stopped and the log file closed.



6.4.10.4 Log file format

Type: text file in European or US American CSV format (depending on the selected setting)

Layout (US format shown):

	A	B	C	D	E	F	G	H	I	J	K	L	M
1	U set	U actual	I set	I actual	P set	P actual	R set	R actual	R mode	Output/Input	Device Mode	Error	Time
2	2.00V	11.92V	1.20A	1.20A	7344W	15W	N/A	N/A	OFF	ON	CC	NONE	00:00:00,942
3	2.00V	11.90V	1.20A	1.20A	7344W	15W	N/A	N/A	OFF	ON	CC	NONE	00:00:00,942
4	2.00V	11.89V	1.20A	1.20A	7344W	15W	N/A	N/A	OFF	ON	CC	NONE	00:00:00,942
5	2.00V	11.87V	1.20A	1.20A	7344W	15W	N/A	N/A	OFF	ON	CC	NONE	00:00:00,942

Legend:

- U set / I set / P set / R set: Set values
- U actual / I actual / P actual / R actual: Actual values
- Error: unit alarms
- Time: elapsed time since logging start
- Unit mode: actual regulation mode (also see section 3.4, “Operating Modes”).

Note: R set and R actual are only recorded if UIR mode is active (refer to section 3.4.5)

Note: Unlike the logging on PC, every log started creates a new log file with a sequence counter in the file name, normally starting with 1, depending on existing files.

6.4.10.5 Special notes and limitations

Following provisions apply to data logging:

- Max. log file size (due to FAT32 formatting): 4 GB
- Max. number of log files in folder HMI_FILES: 1024
- With setting “**Start/stop with DC output ON/OFF**”, the logging will also stop on alarms or events with action “Alarm”, because they switch off the DC output
- With setting “**Manual start/stop**” the unit will continue to log even on occurring alarms, so this mode can be used to determine the period of temporary alarms like OT or PF

6.5 Quick Menu (4U Models only)

4U Power Supplies offer a quick menu which allows for the quick access to often used features and modes being switched on or off in the Settings menu. It can be opened by swiping up from the bottom screen edge or tapping the horizontal bar.

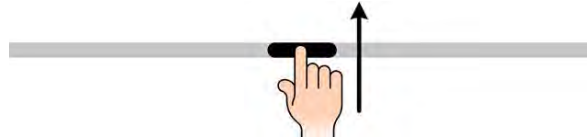

Overview:



Tapping a button activates or deactivates a feature. Buttons in black on white indicate an activated feature.

Symbol	Belongs to	Meaning
	USB logging	USB logging is running (the symbols is only available when USB logging has been activated in menu Settings)
	Master-slave	Master-slave activated, device is master
	Master-slave	Master-slave activated, device is slave
	Master-slave	Master-slave deactivated
	Resistance mode	R mode = on
	HMI	Alarm sound = on
	HMI	Key sound = on
	HMI	Opens the graph screen
	HMI	Adjust backlight intensity
	HMI	Opens the main menu

6.6 The Graph Display

From HMI firmware version 2.02 the devices feature a manually callable, HMI operated visual depiction of the temporal run of the actual values of voltage, current and power, called the graph. It can't record data. For data recording in the background there is the USB logging option (see 3.4.8).

In normal operation the graph can be called anytime via the quick menu, while in function generator operation it's called by an extra screen button. Once called, it completely fills the screen.

Note: Limited control options available while the graph is up! For safety reasons it's, however, possible to switch off the DC output anytime.

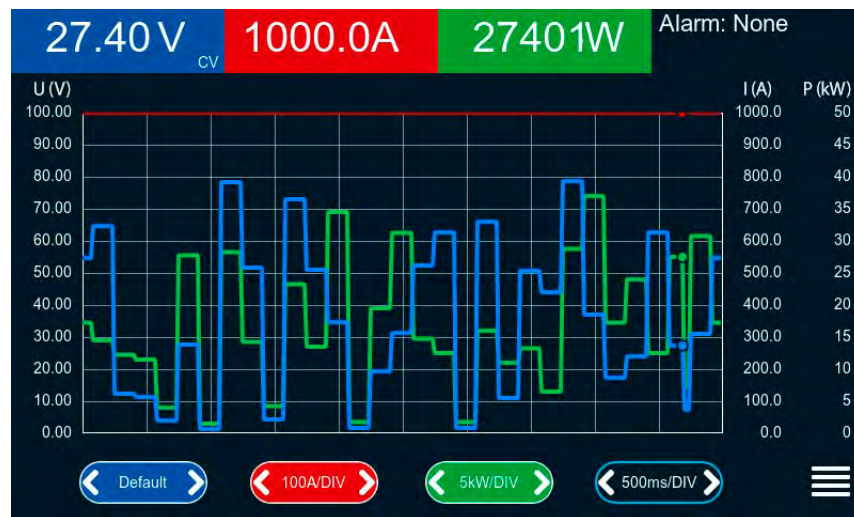

Controls:

- Tapping the middle of the three red/green/blue touch areas deactivates/activate the corresponding plot
- Tapping the sides (arrows left/right) of the red/green/blue touch areas increases/decreases the vertical scaling
- Tapping the sides (arrows left/right) of the black touch area increases/decreases the horizontal scaling
- Swiping on the three scales (Y axis) moves them up or down
- Tapping the menu touch area (☰) exits the graph screen anytime

6.7 Remote Control

This section covers the use of the Analog I/O functions of the power supply. For digital interface use, refer to section 7, “Remote Control Programming” on page 133.

6.7.1 General Analog I/O Info

Remote control is possible via the built-in analog, standard USB port, one of the optional interface modules or via the GPIB port (optional on 3U height models only). Only the analog or one digital interface can be in control.

It means that if, for example, an attempt were to be made to switch to remote control via the digital interface whilst analog remote control is active (Pin Remote = LOW) the unit would report an error via the digital interface. In the opposite direction, an attempt to control the output via Pin Remote would be ignored. In both cases, however, status monitoring and reading of values are always possible.

6.7.2 Control Locations

Control locations are those locations from where the unit can be controlled. Essentially, there are two: at the unit itself (manual operation) and external (remote control). The following locations are defined:

Displayed location	Description
-	If neither of the other control locations is displayed then manual control is active and access from the analog and digital interfaces is allowed. This location is not explicitly displayed
Remote	Remote control via any interface is active
Local	Remote control is locked, only manual operation is allowed.

Remote control may be permitted or inhibited using the setting “Allow remote control” (See section 6.4.3.2, “General Settings Menu” on page 86”). In inhibited condition status “Local” will be displayed in the top right corner of the display. Activating the inhibit can be useful if the unit is remotely controlled by software or some electronic device, but it is required to make adjustments at the unit or deal with emergency, which would not be possible remotely.

Activating the “Local” condition causes the following:

- If remote control via the digital interface is active (“Remote”), then it is immediately terminated and in order to continue remote control once “Local” is no longer active, it has to be reactivated at the PC.
- If remote control via the analog interface is active (“Remote”), then it is temporarily interrupted until remote control is allowed again by deactivating “Local”, because pin “Remote” continues to signal “remote control = on”, unless this has been changed during the “Local” period.

6.7.3 Remote Control using Analog Interface (AI)

The built-in, galvanically isolated, 15-pole analog interface (short: AI) is on the backside of the unit offers the following possibilities:

- Remote control of current, voltage, power and internal resistance
- Remote status monitoring (CC/CP, CV)
- Remote alarm monitoring (OT, OVP, PF)
- Remote monitoring of actual values
- Remote on/off switching of the DC output

6.7.3.1 General Information

Setting the set values of voltage, current and power via the analog interface must always be done concurrently. It means, that for example the voltage can't be given via the AI and current and power set by the rotary knobs, or vice versa. The internal resistance set value can additionally be adjusted.

The OVP set value and other supervision (events) and alarm thresholds cannot be set via the AI and therefore must be adapted to the given situation before the AI will be in control. Analog set values can be supplied by an external voltage or generated from the reference voltage on pin 3. As soon as remote control via the analog interface is activated, the displayed set values will be those provided by the interface.

The AI can be operated in the common voltage ranges 0...5 V and 0...10 V, both representing 0...100% of the nominal value. The selection of the voltage range can be done in the unit setup. See section 6.4.3.2, "General Settings Menu" on page 86 for details. The reference voltage sent out from pin 3 (VREF) will be adapted accordingly:

- 0-5 V: Reference voltage = 5 V, 0...5 V set value signal for VSEL, CSEL, PSEL and RSEL correspond to 0...100% nominal value, 0...100% actual values correspond to 0...5 V at the actual value outputs CMON and VMON.
- 0-10 V: Reference voltage = 10 V, 0...10 V set value signal for VSEL, CSEL, PSEL and RSEL correspond to 0...100% nominal values, 0...100% actual values correspond to 0...10 V at the actual value outputs CMON and VMON.

Input of excess signals (e.g. >5 V in selected 5 V range or >10 V in the 10 V range) are clipped by the unit by setting the corresponding set value to 100%.

Important notes about the use of the interface:

After powering the unit and during the start phase the AI signals undefined statuses on the output pins such as ERROR or OVP. Those must be ignored until is ready to work.

- Analog remote control of the unit must be activated by switching pin "REMOTE" (5) first. Only exception is pin REM-SB, which can be used independently.
- Before the hardware is connected that will control the analog interface, check to make sure that it can't provide voltage to the pins higher than specified
- Set value inputs, such as VSEL, CSEL, PSEL and RSEL (if R mode is activated), must not be left unconnected (i.e. floating) during analog remote control. In case any of

the set values is not used for adjustment, it can be tied to a defined level or connected to pin VREF (solder bridge or jumper), so it drives 100%.



Note: The analog interface is galvanically isolated from the DC output. Therefore, do not connect any ground of the analog interface to the DC- or DC+ output, if not absolutely necessary!

6.7.3.2 Resolution and sample rates

The analog interface is internally sampled and processed by a microcontroller. This causes a limited resolution of analog steps. The resolution is the same for set values (VSEL etc.) and actual values (VMON/CMON) and is 26214 when working with the 10 V range. In the 5 V range this resolution halves to 13107. Due to tolerances, the truly achievable resolution can be slightly lower.

There is furthermore a maximum sample rate of 500 Hz. This means, the unit can acquire analog set values and states on digital input pins 500 times per second or every two msec.

6.7.3.3 Acknowledging unit alarms

Unit alarms are always indicated in the front display and some of them are reported as signal on the analog interface socket. For example, the overvoltage alarm (OVP), which is considered critical.

In case of a unit alarm occurring during remote control via analog interface, the DC output will be switched off, the same way as in manual control. While alarms OT and OVP can be monitored via the corresponding pins of the interface, other alarms like power fail (PF) cannot. These can only be monitored and detected via the actual values of voltage and current being all zero contrary to the set values.

Some unit alarms (OVP, OCP and OPP) have to be acknowledged, either by the user of the unit or by the controlling PC. See section 6.6.2, “Unit Alarm and Event Handling” on page 109. Acknowledgement is done with pin REM-SB switching the DC output off and on again. This requires a HIGH-LOW-HIGH edge sequence (min. 50ms for LOW), when using the default level setting for this pin.

There is an exception: the SOVP (Safety OVP) alarm, which is only featured with the 60 V models of this series. It can't be acknowledged and requires to power-cycle the device. It can be monitored via the analog interface and would be indicated by the alarms PF and OVP being signaled at the same time, so it would require to select the alarm indication on pin 6 to at least signal PF and for pin 14 to signal OVP in any of the combinations.

6.7.3.4 Analog Interface Specifications

Pin	Name	Type*	Description	Default levels	Electrical specifications
1	VSEL	AI	Set voltage value	0...10 V or. 0...5 V correspond to 0..100% of U_{Nom}	Accuracy 0-5 V range: < 0.4% ***** Accuracy 0-10 V range: < 0.2% ***** Input impedance $R_i > 40\text{ k} \dots 100\text{ k}$
2	CSEL	AI	Set current value	0...10 V or. 0...5 V correspond to 0..100% of I_{Nom}	
3	VREF	AO	Reference voltage	10 V or 5 V	Tolerance < 0.2% at $I_{max} = +5\text{ mA}$ Short-circuit-proof against AGND
4	DGND	POT	Ground for all digital signals		For control and status signals.
5	REMOTE	DI	Switching internal / remote control	Remote = LOW, $U_{Low} < 1\text{ V}$ Internal = HIGH, $U > 4\text{ V}$ Internal = Open	Voltage range = 0...30 V $I_{Max} = -1\text{ mA}$ at 5 V. U_{LOW} to HIGH typ. = 3 V Rec'd sender: Open collector against DGND
6	OT / PF	DO	Overheating or power fail*** alarm	Alarm OT= HIGH, $U_{High} > 4\text{ V}$ No Alarm OT= LOW, $U_{Low} < 1\text{ V}$	Quasi open collector with pull-up against V_{cc} ** With 5 V on the pin max. flow +1 mA $I_{Max} = -10\text{ mA}$ at $U_{CE} = 0.3\text{ V}$ $U = 30\text{ V}$ Max Short-circuit-proof against DGND
7	RSEL	AI	Set internal resistance value	0...10 V or. 0...5 V correspond to 0..100% of R_{Max}	Accuracy 0-5 V range: < 0.4% ***** Accuracy 0-10 V range: < 0.2% ***** Input impedance $R_i > 40\text{ k} \dots 100\text{ k}$
8	PSEL	AI	Set power value	0...10 V or. 0...5 V correspond to 0..100% von P_{Nom}	
9	VMON	AO	Actual voltage	0...10 V or. 0...5 V correspond to 0..100% von U_{Nom}	Accuracy < 0.2% at $I_{Max} = +2\text{ mA}$ Short-circuit-proof against AGND
10	CMON	AO	Actual current	0...10 V or. 0...5 V correspond to 0..100% von I_{Nom}	
11	AGND	GND	Ground for all analog signals		For -SEL, -MON, VREF Signals
12	R-ACTIVE	DI	R mode on / off	On = LOW, $U_{Low} < 1\text{ V}$ Off = HIGH, $U_{High} > 4\text{ V}$ Off = Open	Voltage range = 0...30 V $I_{Max} = -1\text{ mA}$ at 5 V U_{LOW} to HIGH typ. = 3 V Rec'd sender: Open collector against DGND
13	REM-SB	DI	DC output OFF (DC output ON) (ACK alarms ****)	Off = LOW, $U_{Low} < 1\text{ V}$ On= HIGH, $U_{High} > 4\text{ V}$ On = Open	Voltage range = 0...30 V $I_{Max} = +1\text{ mA}$ at 5 V Rec'd sender: Open collector against DGND
14	OVP	DO	Overvoltage alarm	Alarm OVP = HIGH, $U_{High} > 4\text{ V}$ No alarm OVP = LOW, $U < 1\text{ V}_{Low}$	Quasi open collector with pull-up against V_{cc} **
15	CV	DO	Constant voltage regulation active	CV = LOW, $U < 1\text{ V}$ Low CC/CP/CR = HIGH, $U > 4\text{ V}$ High	With 5 V on the pin max. flow +1 mA $I_{Max} = -10\text{ mA}$ at $U_{CE} = 0,3\text{ V}$, $U_{Max} = 30\text{ V}$ Short-circuit-proof against DGND

Table 6-3: Analog Interface Specifications

Notes:

* AI = Analog Input, AO = Analog Output, DI = Digital Input, DO = Digital Output, POT = Potential ** Internal V_{cc} approx. 10 V

*** Mains blackout, mains under voltage or PFC error

**** Only during remote control

***** The error of a set value input adds to the general error of the related value on the DC output of the unit

6.7.3.5 Sub-D AI Connector

The 15-pin AI connector pin-out diagram is shown to the right for 3U resp. 4U models.

The equivalent simplified schematic for the various types of I/O pins is shown in the table below.

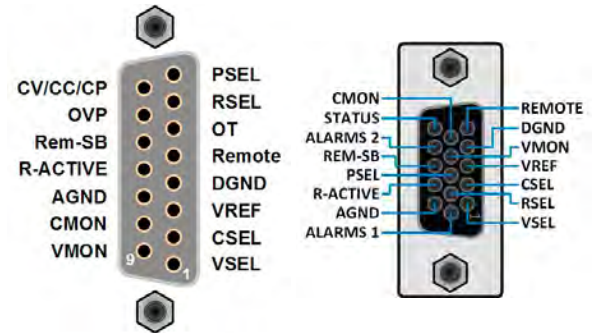

	<p>Digital Input (DI) This input requires the use of a switch with low resistance (relay, switch, circuit breaker etc.) in order to send a clean signal to the DGND.</p>		<p>Analog Input (AI) High resistance input (impedance >40 k....100 kΩ) for an OA circuit</p>
	<p>Digital Output (DO) This is a quasi-open collector, realized using a high resistance pull-up against the internal supply. In condition LOW, it can carry no load, only switch, as shown in the diagram with a relay as an example.</p>		<p>Analog Output (AO) Output from an OA circuit, low impedance. See specifications table above.</p>

6.7.3.6 Application Examples

Example A: Switching the DC output with pin REM-SB

Note: A digital output, e.g. from a PLC, may be unable to cleanly pull down the pin as it may not be of low enough resistance. Check the specification of the controlling application. Also see pin diagrams above.

In remote control, pin REM-SB is used to switch the DC terminal of the unit on and off. This function is also available without remote control being active and can on the one hand block the DC terminal from being switched on in manual or digital remote control and on the other hand, the pin can switch the DC on or off, but not standalone. See below at “Remote control has not been activated”.

It is recommended that a low resistance contact such as a switch, relay or transistor is used to switch the pin to ground (DGND).

Following situations can occur:

- **Remote control has been activated**

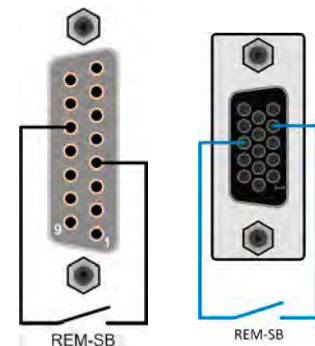

During remote control via the analog interface, only pin “REM-SB” determines the state of the DC output. The logical function and the default levels can be inverted by a parameter in the setup menu.

Note: If the pin is unconnected or the connected contact is open, the pin will be HIGH. With parameter “Analog interface REM-SB” set to “normal”, it requests “DC output on”. So when activating remote control, the DC output will instantly turn on.

- **Remote control is not active**

In this mode of operation pin “REM-SB” can serve as a lockout, preventing the DC output from being switched on by any means. This results in following possible situations:

DC output	+	Pin REM-SB	+	Parameter Rem-SB	-	Behavior
is off	+	HIGH	+	normal	-	DC output not locked. It can be switched on by pushbutton “On/Off” (front panel) or via command from digital interface.
		LOW	+	inverted		
	+	HIGH	+	inverted	-	DC output locked. It cannot be switched on by pushbutton “On/Off” (front panel) or via command from digital interface. When trying to switch on, a popup in the display resp. an error message is generated.
		LOW	+	normal		

In case the DC output is already switched on, toggling the pin will switch the DC output off, similar to what it does in analog remote control:

DC output	-	Pin REM-SB	+	Parameter Rem-SB	+	Behavior
is off	+	HIGH	+	normal	+	DC output remains on, nothing is locked. It can be switched on or off by pushbutton or digital command.
		LOW	+	inverted		
	+	HIGH	+	inverted	+	DC output will be switched off and locked. Later it can be switched on again by toggling the pin. During lock, pushbutton or digital command can delete the request to switch on by pin.
		LOW	+	Normal		

Example B: Remote control of current and power.

Requires remote control to be activated (Pin “Remote” = LOW).

The set values PSEL and CSEL are generated from the reference voltage VREF, using potentiometers for each. Hence, the power supply can selectively work in current limiting or power limiting mode. According to the specification of max. 5 mA for the VREF output, potentiometers of at least 10 kΩ must be used.

The voltage set value VSEL is directly connected to VREF and will thus be permanently 100%.

If the control voltage is fed in from an external source, it is necessary to consider the input voltage ranges for set values (0...5 V or 0...10 V).

Note: Use of the input voltage range 0...5 V for 0...100% set value halves the effective resolution.

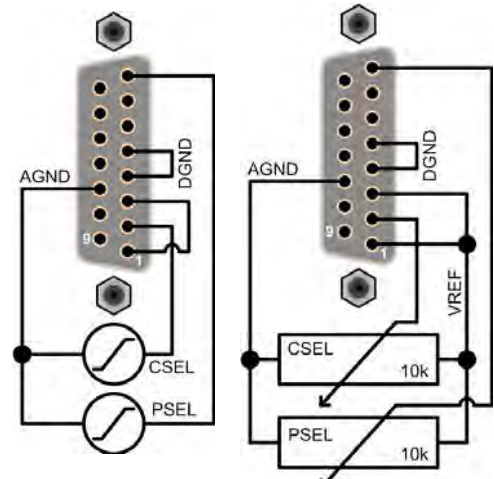

External Source

Potentiometers

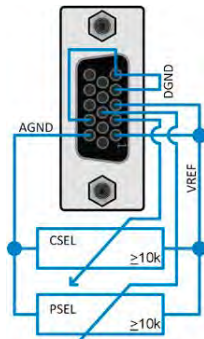
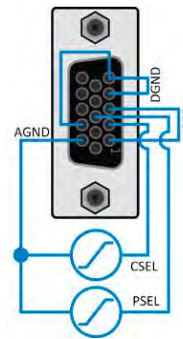

Example C: Reading actual output values

The AI provides the DC output values as current and voltage monitor. These can be read using a standard DMM or similar measurement instrument.

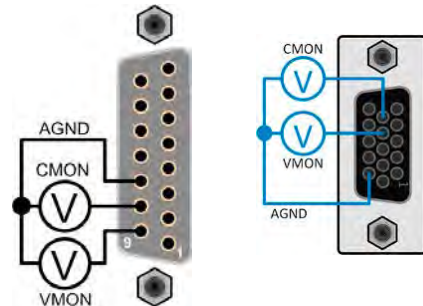

6.8 Alarms and Monitoring

6.8.1 Definition of Terms

There is a clear distinction between unit alarms (section 6.6, “Alarms and Monitoring”, page 109) such as overvoltage protection or overheating protection, and user defined events such as OVD (overvoltage detection). Whereas unit alarms serve to protect the unit by initially switching off the DC output, user defined events can switch off the DC output (Action = ALARM), but can also simply give an audible signal to make the user aware. Available action settings are shown in the table below.





Action	Impact	Example
NONE	User defined event is disabled	
SIGNAL	On reaching the condition that triggers the event, the action SIGNAL will show a text message in the status area of the display.	
WARNING	On reaching the condition that triggers the event, the action WARNING will show a text message in the status area of the display and pop up an additional warning message.	 
ALARM	On reaching the condition which triggers the event, the action ALARM will show a text message in the status area of the display with an additional alarm pop-up, and additionally emit an acoustic signal (if activated). Furthermore, the DC output is switched off. Certain unit alarms are available on the analog interface or can be queried via the digital interface.	 

Table 6-4: Alarm Signals

6.8.2 Unit Alarm and Event Handling

A unit alarm incident will usually lead to the DC output being switched off and the appearance of a pop-up in the middle of the display. Also, if activated, an audible signal is generated to make the user aware of the alarm condition. An alarm must always be acknowledged before the output can be re-enabled.

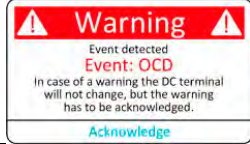
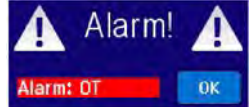
How to acknowledge an alarm in the display (during manual control):

1. If the alarm is indicated as a pop-up, tap the OK button or the **Acknowledge** field.
2. If the alarm has already been acknowledged but is still displayed in the status area, then first tap the status area to display the pop-up, and then acknowledge with OK.

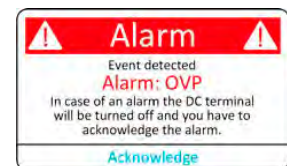

In order to acknowledge an alarm during analog remote control, see section 6.6.2, “Unit Alarm and Event Handling” on page 109. To acknowledge in digital remote operation mode, refer to the programming sections 7.9, 7.10 “ModBus” and 7.12 SCPI”.



Some alarms are configurable:

Short	Long	Description	Range	Indication
OVP	OverVoltage Protection	Triggers an alarm if the DC output voltage reaches the defined threshold. The DC output will be switched off.	0 V...1.1*UNom	Display, analog & digital interface
OCP	OverCurrent Protection	Triggers an alarm if the DC output current reaches the defined threshold. The DC output will be switched off.	0 A...1.1*INom	Display, digital interface
OPP	OverPower Protection	Triggers an alarm if the DC output power reaches the defined threshold. The DC output will be switched off.	0 W...1.1*PNom	Display, digital interface

The following alarms cannot be configured and are based on hardware:

Short	Long	Description	Indication
PF	Power Fail	AC supply over- or under voltage. Triggers an alarm if the AC supply is out of specification or when the unit is cut from supply, for example when switching it off with the power switch. The DC output will be switched off.	Display, analog & digital interface
OT	OverTemperature	Triggers an alarm if the internal temperature reaches a certain limit. The DC output will be switched off.	Display, analog & digital interface
MSP	Master-Slave Protection	Triggers an alarm if the master unit loses contact to any slave unit. The DC output will be switched off. The alarm can be cleared by re-initializing the M/S system.	Display, digital interface
Safety OVP		Only featured on 60 V models: Triggers a special OVP alarm when the voltage on the DC output exceeds the rigid threshold of 101% rated voltage. The DC output will be switched off	Display, analog & digital interface
SF	Share Bus Fail	Can occur in situations where the Share bus signal is damped too much due to wrong or damaged (short-circuit) BNC cables or simply when at least one of the Share bus connectors is wired to another device while the device reporting the isn't (yet) configured for master-slave operation.	Display, digital interface

How to configure unit alarms:



1. While the DC output is switched off, tap the touch area  or  on the main screen.
2. On the right-hand side, tap the arrow to select “2. Protect”.
3. Set the limits for the unit alarms relevant to your application if the default value of 110% is unsuitable.

Note: The set values can be entered using the decimal keypad. This will appear after tapping the touch area “Direct input”.



The user also has the possibility of selecting whether an additional audible signal will be sounded if an alarm or user defined event occurs.

How to configure the alarm sound (also see section 6.4.3, “MENU System Overview” on page 81):

On 3U Models:

- 1 While the DC output is switched off tap the touch area  on the main screen
- 2 In the menu page, tap “HMI Settings”
- 3 In the following menu page, tap “Alarm Sound”
- 4 In the settings page tap on the symbol to either enable or disable the alarm sound and confirm with 

On 4U Models:

1. Swipe your finger up from the bottom edge of the screen or directly tap on the bottom bar.
 
2. The quick menu will open. Tap on  to activate the alarm sound, or on  to deactivate it.
3. Leave the quick menu.

6.8.3 User defined events





The monitoring functions of the unit can also be configured for user defined events. By default, events are de-activated (action = NONE). Contrary to unit alarms, user defined events only work while the DC output is switched on. This means for instance, that you cannot detect under voltage (UVD) anymore after switching the DC output off and the voltage is still sinking.

The following events can be configured independently and can, in each case, trigger the actions NONE, SIGNAL, WARNING or ALARM.

Event	Meaning	Description	Range
UVD	Under Voltage Detection	Triggers an event if the output voltage falls below the defined threshold.	0 V...UNom
OVD	Over Voltage Detection	Triggers an event if the output voltage exceeds the de-fined threshold.	0 V...UNom
UCD	Under Current Detection	Triggers an event if the output current falls below the defined threshold.	0 A...INom
OCD	Over Current Detection	Triggers an event if the output current exceeds the de-fined threshold.	0 A...INom
OPD	Over Power Detection	Triggers an event if the output power exceeds the de-fined threshold.	0 W...PNom

Note: These events should not be confused with alarms such as OT and OVP, which are for unit protection. User defined events can, however, if set to action ALARM, switch off the DC output and thus protect the load, like a sensitive electronic application.

How to configure user defined events:

1. While the DC output is switched off, tap the touch area  or  on the main screen.
2. On the right side, tap the arrows   to select “4.1 Event U” or “4.2 Event I” or “4.3 Event P”.
3. Set the monitoring limits with the left hand rotary knob and the triggered action with the right hand knob relevant to the application (also see 6.6.1, “Definition of Terms” on page 109).
4. Accept the settings with .



Notes:

- User events are an integral part of the actual user profile. Thus, if another user profile or the default profile is selected and used, the events could either be differently configured or not at all.
- The set values can be entered using the decimal keypad. This will appear by tapping the touch area “Direct input”.

6.9 Front Panel Lockout

In order to avoid the accidental modification of a set value during manual operation, the rotary knobs or the touchscreen can be locked so that no change in values will be accepted without prior unlocking.

How to Lock the Front Panel:

1. In the main page, tap the lock symbol  or  (upper right corner).
2. In the settings page “HMI Lock” you are then asked to chose between a complete HMI (“Lock all”) lock or one where the On/Off button is still usable (“ON/ OFF possible”), resp. chose to activate the additional PIN (“Enable PIN”). The unit would later request to enter this PIN every time you want to unlock the front panel, until the PIN is deactivated again.
3. Activate the lock with  or **Start**. The status “Locked” as shown in the figure to the right.

If an attempt is made to alter something while the front panel is locked, a dialog box appears in the display asking if the lock should be disabled.

How to Unlock the Front Panel:

1. Tap any part of the touchscreen of the locked front panel, or turn one of the rotary knobs or press the “On/Off” button (only in “Lock all” situation).

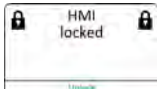
2. This request pop-up will appear:  or .

- Unlock the front panel by tapping on “Tap to unlock” or on **Unlock** within 5 seconds, otherwise the pop-up will disappear and the front panel remains locked. In case the additional PIN code lock has been activated in the menu “**HMI Lock**”, another dialog box will pop up asking you to enter the PIN before it unlocks the front panel.

6.10 Limits Settings Lock

In order to avoid changes in adjustment limits (also see section 6.4.4, “Adjustment or User Limits” on page 94”) by an unauthorized user, the screen with the adjustment limit settings (“Limits”) can be locked by a PIN code. When locked, the menu pages “**3.Limits**” in SETTINGS and “**Profiles**” in MENU will become inaccessible until the lock is removed by entering the correct PIN or in case it has been forgotten, by resetting the unit as last resort.

How to Lock the “Limits” settings:

- While the DC output is switched off, tap the touch area  on the main screen.
- In the menu tap “**Limits Lock**”.
- In the next page set the check mark for “**Lock**”.

Note: The same PIN as for the front panel lock is used here. It should be set before activating the Limits lock. See section 6.7, “Front Panel Lockout” on page 112.

- Activate the lock by leaving the settings page with .



Note: Be careful to enable the lock if you are unsure what PIN is currently set. In doubt use ESC to exit the menu page. In menu page “HMI Lock” you can define a different PIN, but not without entering the old one.

How to Unlock the “Limits” settings:

- While the DC output is switched off, tap the touch area  on the main screen.
- In the menu tap “**Limits Lock**”.
- In the next page set the check mark for “**Lock**”.
- Deactivate the lock by entering the correct PIN and submitting it with ENTER.

6.11 Function Generator Use

6.11.1 FG Introduction

The built-in function generator (short: FG) is able to create various signal forms and apply these to the set value of voltage or current.

The standard functions are based on an arbitrary generator and directly accessible and configurable using manual control. For remote control, the fully customizable arbitrary generator replicates the functions with sequences containing eight parameters each.

The following functions are retrievable, configurable and controllable:

Function	Short description
Sine wave	Sine wave generation with adjustable amplitude, offset and frequency
Triangle	Triangular wave signal generation with adjustable amplitude, offset, rise and fall times
Rectangular	Rectangular wave signal generation with adjustable amplitude, offset and duty cycle
Trapezoid	Trapezoidal wave signal generation with adjustable amplitude, offset, rise time, pulse time, fall time, idle time
DIN 40839	Simulated automobile engine start curve according to DIN 40839 / EN ISO 7637, split into 5 curve sequences, each with a start voltage, final voltage and time
Arbitrary	Generation of a process with up to 99 freely configurable curve points, each with a start and end value (AC/DC), start and end frequency, phase angle and total duration
Ramp	Generation of a linear rise or fall ramp with start and end values and time before and after the ramp
UI, IU	Table (.csv) with values for U or I, uploaded from an USB stick, as well as
PV, FC	Functions to simulate a solar panel (PV function) or fuel cells (FC function), both with table calculation based upon adjustable parameters, plus opportunity to store on USB stick

Table 6-5: Function Generator Capacities Overview

Note: When R mode is activated, access to the function generator is not available.

6.11.2 General FG Description

6.11.2.1 Limitations

The function generator is not accessible, neither in manual nor remote control, if:

- Master-slave mode has been activated and the unit was configured as slave.
- Resistance mode (R/I adjustment, also called UIR) is active.

6.11.2.2 Principle of Operation

The power supply unit cannot be considered as high power function generator, because it is positioned between the function generator output and the load. Thus the typical characteristics of a voltage and current source remain. Rise and fall times, caused by capacitor charge/discharge, affect the resulting signal on the DC output. While the FG is able to generate a sine wave with 1000 Hz or more, the power supply will not be able to track the generated signal exactly.

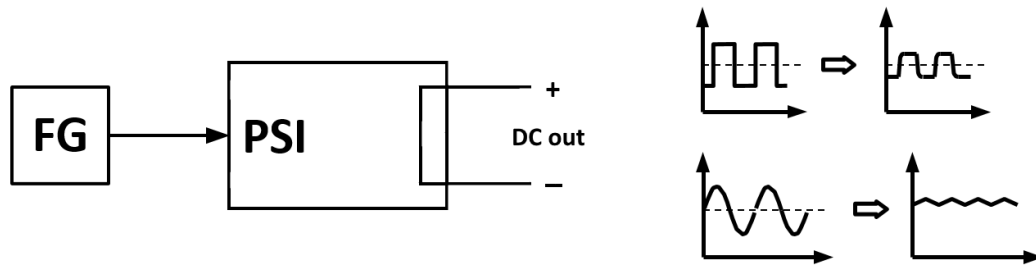

Function Generator principle

Result at the power supply output:

The resulting wave on the DC output heavily depends on the frequency response of the selected wave, its amplitude and the power supply model. The effects of capacitance on the wave can be partially compensated. A high-speed modification, like offered with option HS,

can help to decrease rise and fall times. It has a positive impact on periodic functions like rectangle or sine wave. Alternatively, the resulting waveform on the DC output can also be improved by attaching additional load (fixed & resistive or variable & electronic).

6.11.2.3 Resolution

Amplitudes generated by the arbitrary generator have an effective resolution of approx. 52428 steps. If the amplitude is very low and the time period long, the unit would generate less steps and set multiple identical values after another, generating a staircase effect. It is furthermore not possible to generate every possible combination of time and a varying amplitude (slope).

The XY generator, which works in table mode, has an effective resolution of 3276 steps for the set value range of 0-100% rated value.

6.11.2.4 Possible Technical Complications

Operation of switching mode power supplies as a voltage source can, when applying a function to the output voltage, lead to damage of the output capacitors due to continuous charging/discharging, which causes overheating. Furthermore, the actual voltage progression may differ from what is expected.

6.11.2.5 Minimum Slope / Maximum Ramp Time

When using a rising or falling offset (i.e. DC part) at functions like ramp, trapezoid, triangle and even sine wave, a minimum slope, calculated from the rated values of voltage or current, is required or else the adjusted settings would be neglected by the unit. Calculating the minimum slope can help to determine if a certain ramp over time can be achieved by the unit or not.

Example: A model DCSB80-120-2 is going to be used, with 80 V and 120 A rating. Formula: minimum slope = $0.000725 \cdot \text{rated value} / s$. For this model, this results in $\Delta U/\Delta t$ of 58 mV/s and $\Delta I/\Delta t$ of 87 mA/s. The maximum time which can be achieved with the minimum slope then calculates as approximately 1379 seconds according to formula **$t_{\text{Max}} = \text{rated value} / \text{min. slope}$** .

6.11.3 Method of Operation

In order to understand how the function generator works and how the value settings interact, the following should be noted:

The unit operates, including in function generator mode, with the three set values U, I and P at all times.

The selected function can be used on one of both the values U or I, the other two are then constants and have a limiting effect. That means if a voltage of 10 V is set for the DC output, a load is connected and a sine wave function should operate on the current with an amplitude of 20 A and offset 20 A, then the function generator will create a sine wave progression of current between 0 A (min) and 40 A (max), which will result in an output

power between 0 W (min) and 400 W (max). The output power, however, is limited to its set value. If this were 300 W then the current would be limited to 30 A and, if clamped to an oscilloscope, it would be seen to be capped at 30 A and never achieve the target of 40 A.

6.11.4 Manual Operation

Via the touchscreen, one of the available FG functions can be called up, configured and controlled. Selection and configuration are only possible when the DC output is switched off.





How to select a function and adjust parameters

1. While the DC output is switched off tap the touch

area  on the main screen.



2. In the menu tap on the touch area

 or  and then on the desired function.

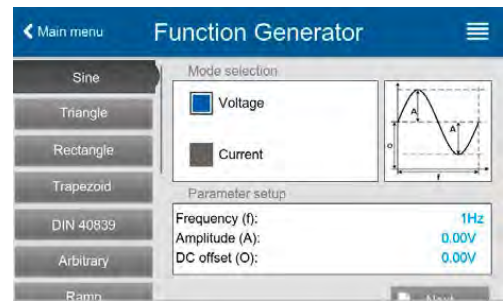
Note: this touch area is locked in R mode (adjustable resistance).



3. Depending on the choice of function there follows a request to which value the function

generator is going to be applied:  or .

4. Adjust the parameters as you desire, like offset, amplitude and frequency for a sine wave, for example.

5. Adjust the overall limits of voltage, current and power, which you can access with touch

area .

Note: When entering function generator mode, these limits are reset to safe values, which can prevent the function from working at all. For example, if you apply the selected function to the output current, then the overall current limit should not interfere and should at least be as high as offset + amplitude.

How to Load a Function:

1. After setting the values for the required signal

generation, tap on the touch area .

The unit will then load the data into the internal controller and changes the display. Shortly afterwards the static values are set (power and voltage or current), the DC

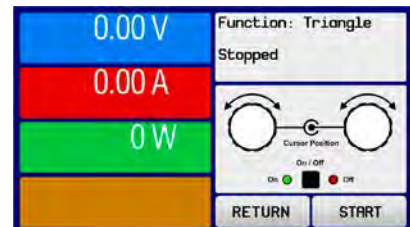

output is switched on and the touch area **START** is enabled. Only then can the function output be started.

Note: The static values are applied to the DC output immediately after loading the function as it switches the DC output on automatically in order to set the start condition. They represent start and end values for the progress of the function, so that it does not need to start from 0. Only exception: when applying a function to the current (I), there is no adjustable static current value, so the function will always start from 0 A

How to Start and Stop a Function:

1. The function can be started either by tapping **START** ,  or pushing the “On/Off” button, if the DC output is currently switched off. The function then starts immediately. In case START is used while the DC output is still switched off, it will be switched on automatically.

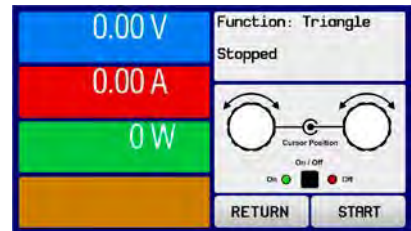

2. The function can be stopped either by tapping **STOP** or operating the “On/Off” button. However, there is a difference:

- a. The **STOP** or  button stops only the function, the DC output **remains ON** with the static values.
- b. The “On/Off” button stops the function and switches off the DC output.

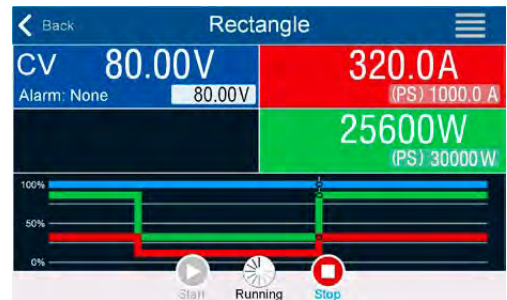

Note: Any unit alarm (over voltage, over temperature etc.), protection (OPP, OCP) or event with action = Alarm stops the function progress automatically and switches off the DC output. It also reports the alarm condition.

6.11.5 Sine Wave Function

The following parameters can be configured for a sine wave function:

Value	Range	Description
I(A), U(A)	0...(Nominal value - (Offs)) of U, I	A = Amplitude of the signal to be generated
I(Offs), U(Offs)	(A)...(Nominal value - (A)) of U, I	Offs = Offset, based on the zero point of the mathematical sine curve, may not be smaller than the amplitude.
f (1/t)	1...10000 Hz	Static frequency of the signal to be generated

Schematic Diagram:

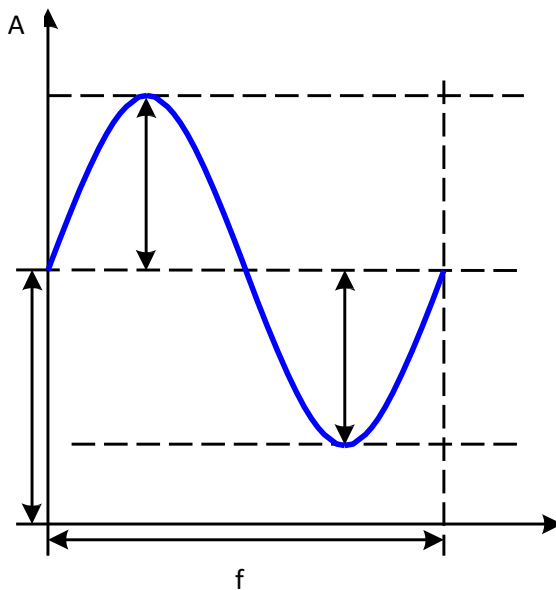

Application and Result:

A normal sine wave signal is generated and applied to the selected set value, e.g. voltage (U). At a constant load resistance, the output voltage and thus the output current will follow a sine wave.

For calculating the maximum power output, the amplitude and offset values for the current have to be added.

Example: An output voltage of 100 V is set together with sin(I) with an amplitude of 30 A and an offset of 50 A. The resulting maximum power output is then achieved at the highest point of the sine wave and is $(30 \text{ A} + 50\text{A}) * 100 \text{ V} = 8000 \text{ W}$

6.11.6 Triangular Function

The following parameters can be configured for a triangular wave function:

Value	Range	Description
I(A), U(A)	0...(Nominal value - (Offs)) of U, I	A = Amplitude of the signal to be generated
I(Offs), U(Offs)	0...(Nominal value - (A)) of U, I	Offs = Offset, based on the foot of the triangular wave
t1	0.1 ms...36000 s	Rising edge time Δt of the triangular wave signal
t2	0.1 ms...36000 s	Falling edge time Δt of the triangular wave signal

Schematic Diagram:

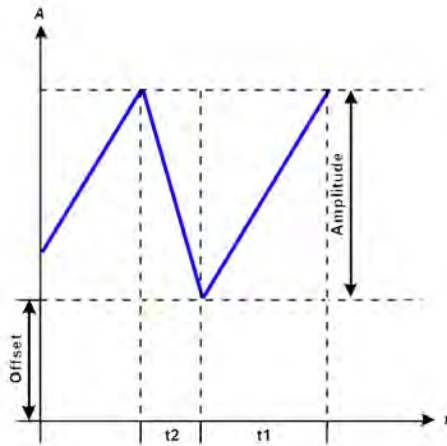

Application and Result:

A triangular wave signal for output current (only effective in current limiting) or output voltage is generated. The positive and negative slope times can be set independently. The offset shifts the signal on the Y-axis. The sum of the intervals t1 and t2 gives the cycle time and its reciprocal is the frequency.

Example: A frequency of 10 Hz is required and would lead to periodic duration of 100 ms. This 100 ms can be freely allocated to t1 and t2, e.g. 50 ms:50 ms (isosceles triangle) or 99.9 ms:0.1 ms (right-angled triangle or saw tooth).

6.11.7 Rectangular Function

The following parameters can be configured for a rectangular wave function:

Value	Range	Description
I(A), U(A)	0...(Nominal value - (Offs)) of U, I	A = Amplitude of the signal to be generated
I(Offs), U(Offs)	0...(Nominal value - (A)) of U, I	Offs = Offset, based on the foot of the rectangular wave
t1	0.1 ms...36000 s	Time (pulse width) of the upper level (amplitude)
t2	0.1 ms...36000 s	Time (pause width) of the lower level (offset)

Schematic Diagram:

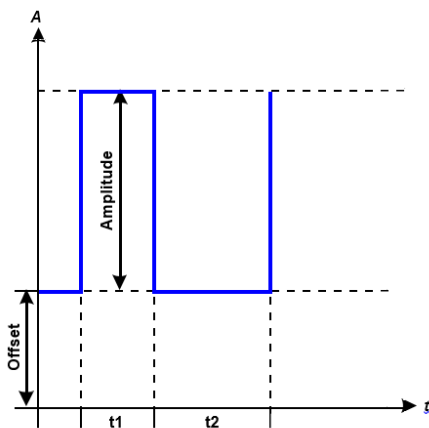

Application and Result:

A rectangular or square wave signal for input current (direct) or input voltage (indirect) is generated. The intervals t1 and t2 define how long the value of the amplitude (pulse) and how long the value of the offset (pause) are effective. The offset shifts the signal on the Y axis. Intervals t1 and t2 can be used to define a duty cycle. The sum of t1 and t2 gives the period and its reciprocal is the frequency.

Example: a rectangular wave signal of 25 Hz and a duty cycle of 80% are required. The sum of t1 and t2, the period, is $1/25 \text{ Hz} = 40 \text{ ms}$. For a duty cycle of 80% the pulse time (t1) is $40 \text{ ms} \cdot 0.8 = 32 \text{ ms}$ and the pause time (t2) is 8 ms.

6.11.8 Trapezoidal function

The following parameters can be configured for a trapezoidal curve function:

Value	Range	Description
I(A), U(A)	0...(Nominal value - (Offs)) of U, I	A = Amplitude of the signal to be generated
I(Offs), U(Offs)	0...(Nominal value - (A)) of U, I	Offs = Offset, based on the foot of the trapezium
t1	0.1 ms...36000 s	Time for the positive slope of the trapezoidal wave signal
t2	0.1 ms...36000 s	Time for the top value of the trapezoidal wave signal
t3	0.1 ms...36000 s	Time for the negative slope of the trapezoidal wave signal.
t4	0.1 ms...36000 s	Time for the base value (offset) of the trapezoidal wave signal

Schematic Diagram:

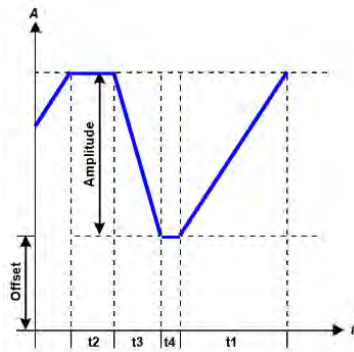

Application and Result:

Here a trapezoidal signal can be applied to a set value of U or I. The slopes of the trapezium can be varied by setting different times for rise and fall.

The periodic duration and repetition frequency are the result of four time elements. With suitable settings, the trapezium can be deformed to a triangular or rectangular wave. It has therefore universal use.

6.11.9 DIN 40839 Function

This function is based on the curve defined in DIN 40839 / EN ISO 7637 (test impulse 4), and is only applicable to voltage. It replicates the progress of automobile battery voltage during engine starting. The curve is divided into 5 sequences (see diagram below) which each have the same parameters. The standard values from the DIN are set already as default values for the five sequences.

The following parameters can be configured for the DIN40839 function -For 3U models:

Value	Range	Seq	Description
Ustart	0...Nominal value of U	1-5	Start voltage of the ramp
Uend	0...Nominal value of U	1-5	End voltage of the ramp
Seq.time	0.1 ms...36000 s	1-5	Time of the ramp
Seq.cycles	∞ or 1...999	-	Number of repetitions of the entire curve
Time t1	0.1 ms...36000 s	-	Time after cycle before repetition (cycle <> 1)

For 4U models

Value	Range	Seq	Description
Ustart	0...Nominal value of U	1-5	Start voltage of the ramp
Uend	0...Nominal value of U	1-5	End voltage of the ramp
Time	0.1 ms...36000 s	1-5	Time of the ramp
Cycles	∞ or 1...999	-	Number of repetitions of the entire curve (0 = infinity)
Time t1	0.1 ms...36000 s	-	Time after cycle before repetition (cycle <> 1)
U (Start / End)	0..U _{Nom}	-	Voltage setting before and after the function run
I/P	0..I _{Nom} / P _{Nom}	-	Global set values of current and power

Schematic Diagram:

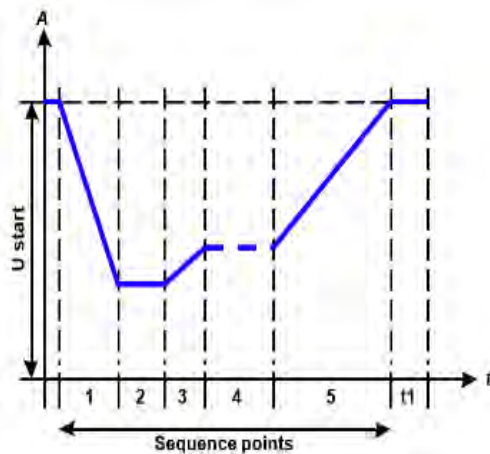

Application and Result:

The function is not suitable for standalone operation of a power supply, but optimal for power supply in conjunction with an electronic load, for example one from 6RL series. The load acts as a sink for the rapid fall of the output voltage of the power supply enabling the output voltage progress to follow the DIN curve.

The curve conforms to test impulse 4 of the DIN. With suitable settings, other test impulses can be simulated. If the curve in point 4 should be a sine wave, then these 5 points have to be transferred to the arbitrary generator.

6.11.10 Arbitrary Function

The arbitrary (freely definable) function offers the user further scope. There are 99 sequence points are available for use for current I and voltage U, all of which have the same parameters but which can be differently configured so that a complex function process can be built up. The 99 sequence points or a part of them can run one after another in a sequence point block, and this block can then be repeated many times or endlessly. A sequence point or sequence point block acts only on current or voltage, thus a mix of assignment to current I or voltage U is not possible.

The arbitrary curve overlays a linear progression (DC) with a sine curve (AC), whose amplitude and frequency are shaped between start and end values. If the start frequency (f_s) = end frequency (f_e) = 0 Hz, the AC values have no impact and only the DC part is effective. Each sequence is allocated a sequence time in which the AC/ DC curve from start to finish will be generated.

The following parameters can be configured for each sequence in the arbitrary function (the table lists parameters for current, for voltage it would be U_s , U_e etc.).

For 3U Models:

Value	Range	Description
$I_s(AC)$	0...50% Nominal value of I	Start amplitude of the sine wave part of the curve
$I_e(AC)$	0...50% Nominal value of I	End amplitude of the sine wave part of the curve
$f_s(1/T)$	0 Hz...10000 Hz	Start frequency of the sine wave part of the curve (AC)
$f_e(1/T)$	0 Hz...10000 Hz	End frequency of the sine wave part of the curve (AC)
Angle	0°...359°	Start angle of the sine wave part of the curve (AC)
$I_s(DC)$	$I_s(AC) \dots (\text{Nominal value} - I_s(AC))$ of I	Start value of the DC part of the curve
$I_e(DC)$	$I_e(AC) \dots (\text{Nominal value} - I_e(AC))$ of I	End value of the DC part of the curve
Seq.time	0.1 ms...36000 s	Time for the selected sequence point

For 4U Models:

Value	Range	Description
AC start	0...50% Nominal value of U or I	Start / end amplitude of the sine wave part of the curve
AC end		
DC Start	AC start...((Nominal of U or I) - (AC start))	Start amplitude of the DC part
DC end	AC end...((Nominal of U or I) - (AC end))	End amplitude of the DC part
Start / Stop Freq	0 Hz ... 10000 Hz	Start/end frequency of the sinusoidal AC part
Angle	0° ... 359°	Start angle of the sinusoidal AC part
Time	0.1 ms...36,000,000 ms	Time for the selected sequence

Note: The sequence point time (seq. time) and the start and end frequency are related. The minimum value for $\Delta f/s$ is 9.3. Thus, for example, a setting of $f_s = 1$ Hz, $f_e = 11$ Hz and Seq.time = 5 s would not be accepted as $\Delta f/s$ is only 2. A seq. time of 1 s would be accepted, or, if the time remains at 5 s, then $f_e = 51$ Hz must be set.

Note: The amplitude change between start and end is related to the sequence time. A minimal change over an extended time is not possible and in such a case the unit will report an inapplicable setting.

After the settings for the selected sequence are accepted with SAVE, further sequence points can be configured. If the button NEXT is touched a second settings screen appears in which global settings for all 99 sequence points are displayed.

The following parameters can be set for the total run of an arbitrary function:

Value	Range	Description
Start seq.	1...End seq.	First sequence point in the sequence point block
End seq.	Start seq...99	Last sequence point in the sequence point block
Seq. Cycles	∞ or 1...999	Number of cycles of the sequence point block

Schematic Diagram:

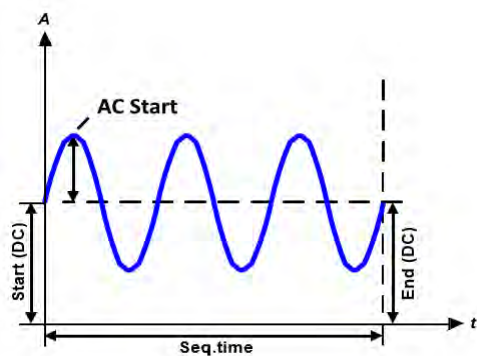

Application and Result:

Example 1: Focusing 1 cycle of 1 sequence point out of 99: DC values for start and end are the same, also the AC amplitude. With a frequency >0 a sine wave progression of the set value is generated with a defined amplitude, frequency and offset (DC value at start and end). The number of sine waves per cycle depends on the sequence point time and the frequency. If the time were 1s and the frequency 1Hz, there would be exactly 1 sine wave. If the time were 0.5 s at the same frequency, there would only be a half sine wave.

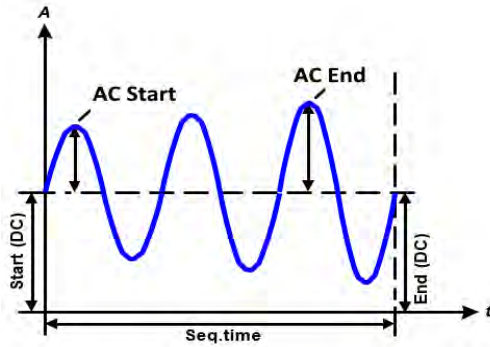

Example 2: Focusing 1 cycle of 1 sequence point out of 99:

The DC values at start and end are the same but the AC (amplitude) not. The end value is higher than the start so that the amplitude increases with each new half sine wave continuously through the sequence. This, of course, only if the sequence point time and frequency allow multiple waves to be created. E.g. for $f=1$ Hz and Seq. time = 3 s, three complete waves would be generated (for angle = 0°) and reciprocally the same for $f=3$ s and Seq. time=1s.

TBD Continue here pg 75 ea man.

Schematic Diagram:	Application and Result:
	<p>Example 3: Focusing 1 cycle of 1 sequence point out of 99:</p> <p>The DC values at start and end are unequal, as are also the AC values. In both cases, the end value is higher than the start so that the offset increases from start to end (DC) and the amplitude also with each new half sine wave.</p> <p>Additionally the first sine wave starts with a negative half wave because the angle is set at 180°. The start angle can be shifted at will in 1° steps between 0° and 359°.</p>
	<p>Example 4: Focusing 1 cycle of 1 sequence point out of 99:</p> <p>Similar to example 1 but with another end frequency. This is shown here as higher than the start frequency. This affects the period of the sine waves such that each new wave will be shorter over the total span of the sequence point time.</p>
	<p>Example 5: Focusing 1 cycle of 1 sequence point out of 99:</p> <p>Similar to example 1 but with a start and end frequency of 0 Hz. Without a frequency, no sine wave part (AC) will be created and only the DC settings will be effective. A ramp with a horizontal progression is generated.</p>
	<p>Example 6: Focusing 1 cycle of 1 sequence point out of 99:</p> <p>Similar to example 1 but with a start and end frequency of 0 Hz. Without a frequency no sine wave part (AC) will be created and only the DC settings will be effective. Here start and end values are unequal and a steadily increasing ramp is generated.</p>

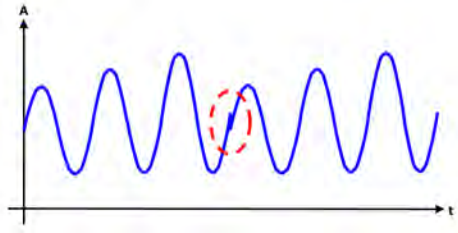
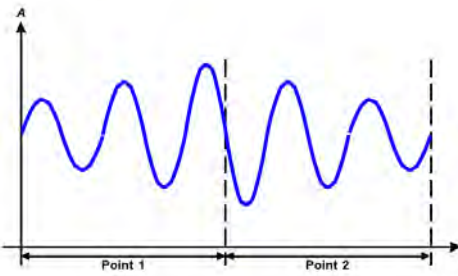
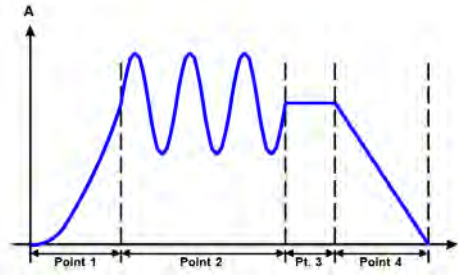
<p>By linking together a number of differently configured sequence points, complex progressions can be created. Smart configuration of the arbitrary generator can be used to match triangular, sine, rectangular or trapezoidal wave functions and thus, e.g. a curve of rectangular waves with differing amplitudes or duty cycles could be produced</p>	
Schematic Diagram:	Application and Result:
	<p>Example 7: Focusing 2 cycles of 1 sequence point out of 99:</p> <p>A sequence point configured as in example 3 is run. As the settings demand that the end offset (DC) is higher than the start, the second sequence point run will revert to the same start level as the first, regardless of the values achieved at the end of the first run. This can produce a discontinuity in the total progression (marked in red) which can only be compensated with careful choice of settings.</p>
	<p>Example 8: Focusing 1 cycle of 2 sequence points out of 99:</p> <p>Two sequence points run consecutively. The first one generates a sine wave with increasing amplitude, the second one with a decreasing amplitude. Together they produce a progression as shown left. In order to ensure that the maximum wave in the middle occurs only once, the first sequence point must end with a positive half wave and the second one start with a negative half wave as shown in the diagram.</p>
	<p>Example 9: Focusing 1 cycle of 4 sequence points out of 99:</p> <p>Point 1: 1/4th sine wave (angle = 270°) Point 2: 3 Sine waves (ratio of frequency to sequence time: 1:3) Point 3: Horizontal ramp (f = 0) Point 4: Falling ramp (f = 0)</p>

6.11.10.1 Loading and Saving Arbitrary Functions

The 99 sequence points of the arbitrary function, which can be manually configured with the control panel of the unit and which are applicable to voltage (U) or current (I), can be saved to or loaded from a common USB memory stick via the front side USB port. Generally, all sequence points are saved or loaded using a CSV text file (semicolon separator), which represents a table of values.

In order to load a sequence point table for the arbitrary generator, following requirements have to be met:

- The table must contain exactly 99 rows with 8 subsequent values (8 columns) and must not have gaps
- The column separator (semicolon, comma) must be as selected by MENU parameter “USB file separator format”; it also defines the decimal separator (dot, comma)
- The files must be stored inside a folder called HMI_FILES which has to be in the root of the USB drive
- The file name must always start with WAVE_U or WAVE_I (not case-sensitive)
- All values in every row and column have to be within the specified range (see below)
- The columns in the table have to be in a defined order which must not be changed
- Following value ranges are given for use in the table, related to the manual configuration of the arbitrary generator (column headers like in Excel):

Column	Parameter	Range
A	AC start amplitude	0...50% U or I
B	AC end amplitude	0...50% U or I
C	Start frequency	0...1000 Hz
D	End frequency	0...1000 Hz
E	AC start angle	0...359°
F	DC start offset	0...(Nominal value of U or I) - AC Start
G	DC end offset	0...(Nominal value of U or I) - AC End
H	Sequence point time in μ s	100...36.000.000.000 (36 billion μ s)

Example CSV:

	A	B	C	D	E	F	G
1	20.00	30.00	5	90	50.00	50.00	50000000
2	30.00	20.00	5	90	50.00	50.00	30000000
3	0.00	0.00	0	0	0.00	0.00	1000
4	0.00	0.00	0	0	0.00	0.00	1000
5	0.00	0.00	0	0	0.00	0.00	1000
6	0.00	0.00	0	0	0.00	0.00	1000
7	0.00	0.00	0	0	0.00	0.00	1000

The example shows that only the first two sequence points are configured, while all others are set to default values. The table could be loaded as WAVE_U or WAVE_I when using, for example, the model DCS80-170-2.



3U, because the values would fit both, voltage and current. The file naming, however, is unique. A filter prevents you from loading a WAVE_I file after you have selected “Arbitrary -- > U” in the function generator menu. The file would not be listed at all.

How to load a sequence table from an USB stick:

1. Do not plug the USB drive yet or remove it.

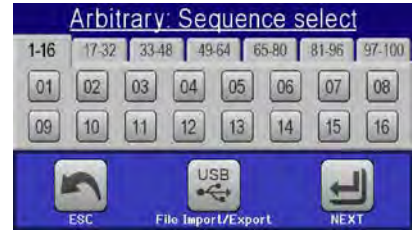
2. Access the function selection menu of the function generator with MENU ► Function Generator ► Arbitrary ► U/I, to see the main screen of sequence selector, as depicted to the right.



3. Tap touch area , then  and follow the instructions on screen. If at least one valid files has been recognized (for file and path naming see above), the unit will show a list of files to select from with .





4. Tap touch area  in the bottom right corner. The selected file is then checked and loaded, if valid. In case it is not valid, the unit will show an error message. Then the file must be corrected and the steps repeated.

How to save a sequence table to an USB stick:

1. Do not plug the USB stick yet or remove it.
2. Access the function selection menu of the function generator via MENU -> Function Generator -> Arbitrary



3. Tap on , then . The unit will request you to plug the USB stick now.
4. After plugging it, the unit will try to access the stick and find the folder HMI_FILES and read the content. If there are already WAVE_U or WAVE_I files present, they will be listed and you can either select one for overwriting with , otherwise select **-NEW FILE-** for a new file.



5. Finally save the sequence table with 

6.11.11 Ramp Function

The following parameters can be configured as the basis for a ramp function:

Value	Range	Description
Ustart / Istart	0...Nominal value of U, I	Start value (U,I)
Uend / Iend	0...Nominal value of U, I	End value (U, I)
t1	0.1 ms...36000 s	Time before ramp-up or ramp-down of the signal.
t2	0.1 ms...36000 s	Ramp-up or ramp-down time

Schematic Diagram:

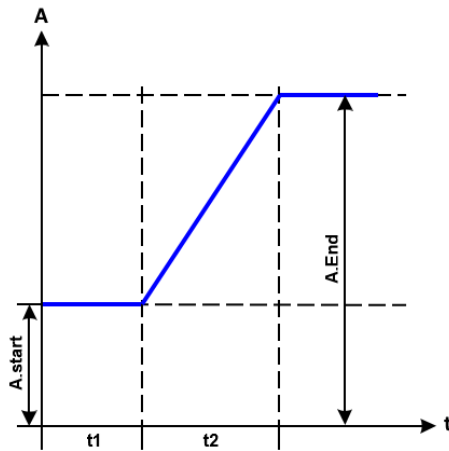

Application and Result:

This function generates a rising or falling ramp between start and end values over the time t2. Time t1 creates a delay before the ramp starts.

The function runs once and stops at the end value. To have a repeating ramp, function Trapezoid would have to be used instead. (See section 6.9.8).

Important to consider are the static values of U and I which define the start levels at the beginning of the ramp. It is recommended that these values are set equal to those in A.start, unless the load at the DC output should not be provided with voltage before the start of the

ramp. In that case, the static values should be set to zero.

Note: Ten hours after reaching the ramp end, the function will stop automatically (i.e. I = 0 A, in case the ramp was assigned to the current), unless it is stopped manually before.

6.11.12 UI and IU Table Functions (XY Table)

The UI and IU functions offer the user the possibility to set a DC output current dependent on the DC output voltage, or a DC output voltage dependent on the DC output current. The function is table driven with exactly 4096 values, which are distributed over the entire measured range of actual output voltage or output current values in the range of 0...125% Unom or Inom. The table can either be uploaded from an USB memory stick through the front side USB port of the unit or via remote control (ModBus protocol or SCPI). The functions are:

UI function: $U = f(I)$

IU function: $I = f(U)$

In the **UI function**, the equipment measuring circuit determines the level from 0 to maximum of the output current. For each of the 4096 possible values for output current, a voltage value is maintained by the user in the UI table, which can be any value between 0 and nominal value. The values uploaded from an USB stick will always be interpreted as voltage values even if the user calculated them as current values and incorrectly loaded them as an UI table. The UI function is suitable for simulating fuel cell characteristics.

In the **IU function**, the assignment of the values is the other way round, the behavior, however, the same. Thus, the behavior of the load or the current and power consumption can be controlled with dependence on output voltage and step changes can be created.

The IU function is suitable for the simulating solar panels in photovoltaics related tests.

Note: Uploading of a table from an USB memory stick requires the use of text files in CSV format (*.csv). Integrity is checked on loading (values not too high, number of values correct) and possible errors reported in which case the table will not be loaded.

Note: The 4096 values in the table are only checked for value and valid number of data points. If all the values were to be graphically plotted, a curve would be created which could include significant step changes in current or voltage. That could lead to complications for connected loads if, for example, the internal current measurement in the power supply swings slightly so that the voltage jumps backwards and forwards between two values in the table, which, in the worst case scenario, could be 0V and the maximum voltage.



6.11.12.1 Loading UI and IU tables from USB drive:

The so-called UI or IU value tables can be loaded from a file via a standard USB memory stick formatted as a FAT32 file system. In order to load the file, it has to meet following specifications:

- The file name always begins with IU or UI (not case-sensitive), depending on which of the two function you load the table for
- The file must be a text file of type Excel CSV and must only contain one column with exactly 4096 values without gaps
- Values with decimal places must use a decimal separator as depending on the selection with parameter “USB file separator format” (“US”: separator = comma, decimal separator = dot)
- No value may exceed the nominal value of the unit. For example, if you have an 80 V model and you are going to load a table with values for voltage, none of the 4096 values may be higher than 80 V (the adjustment limits from the unit’s front panel do not apply here)
- The file(s) has/have to be put inside a folder named HMI_FILES in the root directory of the.

If these specifications are not met, the unit will not accept the file and display an error message on the display. Files with names beginning different to UI or IU are not recognized for this purpose. The USB drive may contain multiple UI/IU files with different names and list them for the selection of one.

How to load an UI or IU table from an USB drive:

1. Do not plug the USB drive yet or pull it out if already plugged.
2. Open the function selection menu of the function manager with MENU -> Function Generator -> XY Table
3. In the next scree select the desired function with either “UI Table” or “IU Table”.
4. Configure the global parameters for U, I and P, as necessary.
5. Tap touch area  and plug the USB drive when requested, in order to select one out of X compatible files from the drive. In case the file is not accepted, the unit display an error and state what is wrong with the file.

6. Once the file is accepted, remove the USB drive.



7. Submit and load the function with  to start and control it as with other functions.

6.11.13 PV Table Function (Photovoltaics)

This function uses the standard XY generator to let the power supply simulate solar panels or solar cells with certain characteristics. The unit calculates an IU table from four typical values.

While the function is running, the user can adjust a parameter “Irradiance” between 0% (darkness) and 100% (bright light) in 1% steps to simulate different light situations.

The most important characteristics of a solar cell are:

- The short-circuit current (ISC), which is proportional to the irradiance
- The open circuit voltage (UOC), which almost reaches its maximum value even in low light situations
- The maximum power point (MPP), at which the solar panel can provide the maximum output power

The voltage of the MPP (here: UMPP) lies typically 20% below UOC, the current of the MPP (here: IMPP) lies typically 5% below ISC. In case there are no definite values for the simulated solar cell available, Impp and Umpp can be set to this rule of thumb. The unit limits the IMPP value to ISC as upper limit, the same applies to UMPP and UOC.

Note: Be aware that the standard versions of the DCS models may not be fast enough in the voltage regulation circuit to follow the fast tracking behavior of a solar inverter. This is due to the normal output capacity of the power supply. In these cases, the resulting problems may be eliminated by using modified versions with the option, which offers reduced output capacitance.



6.11.13.1 Safety Considerations

Note: Due to high capacitance on the DC outputs of the power supplies, not every available solar inverter can be operated without problems. Check the technical specifications of the solar inverter and preferably contact the manufacturer for an evaluation. In case the –HS option is installed in the unit, the result of operating certain inverters can be optimized.



6.11.13.2 PV Test Usage

In the PV table function, which is based upon the XY generator with IU characteristics, the MPP is defined by the two adjustable parameters U_{mpp} and I_{mpp} (also see diagram below). These parameters are usually stated in data sheets of solar panels and have to be entered here.

The following parameters can be set for the PV table function:

Value	Range	Description
U_{oc}	U_{mpp} ...Nominal unit voltage	Open circuit voltage at no load
I_{sc}	I_{mpp} ...Nominal unit current	Short-circuit current at max. load and low voltage
U_{mpp}	0 V... U_{oc}	DC output voltage at the MPP
I_{mpp}	0 A... I_{sc}	DC output current at the MPP

Schematic Diagram:

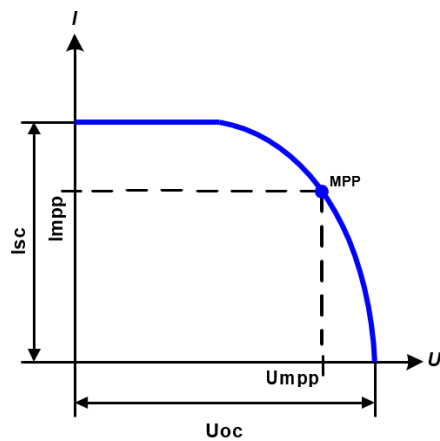

Application and Result:

Adjust all four parameters on screen to the desired values. Whether the calculated IU and P curves, which result from those values, make sense or not can be verified with a tool (Excel table or small software), which is either included with the unit on USB memory stick or can be obtained upon request. The tool visualizes the curves as calculated from the adjusted values.

While the simulation is running, the user can see from the actual values (voltage, current, power) of the DC output, where the operating point of the power supply resp. of the simulated

solar panel is. The adjustable value I_r - radiance (0%...100% in 1% steps, see screenshot below) helps to simulate different light situations from darkness (no power output) to the minimal amount of light that is required to make the panel provide full power.

Varying this parameter shifts the MPP and the PV curve along the Y axis. Also, see diagram to the right. The value Irradiance is used as a factor for the current I_{mpp} . The curve itself is not permanently re-calculated.

How to Configure the PV Table:

1. In the function generator menu tap



on , then



2. Adjust the four parameters as required for the simulation.

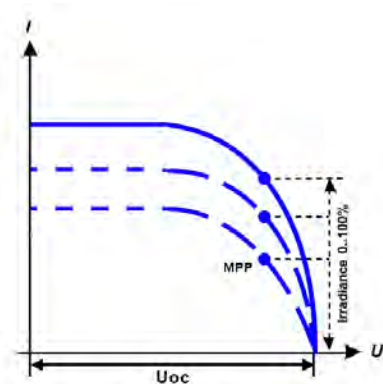

- Do not forget to adjust the global limits for voltage and power in the next screen



which you can access with touch area . The voltage (U) setting should be at least as high as U_{oc} , or higher.

- After setting the values for the required signal generation, tap on touch area



While loading, the IU function is calculated and sent to the internal XY generator. After this, the function is ready to run.

Note: The function can be saved to USB memory as a table, as well as read via any of the digital interfaces. In remote control, the function cannot be loaded or controlled.

From the screen where the XY function generator is controlled manually (start/stop), you can go back to the first screen of PV table function and use the formerly locked touch area to save the table to the USB drive. To do so, follow the on-screen instructions. The table can be used to analyze the values or to visualize it in Excel or similar tools.

How to use the PV Table Function:

- With an appropriate load connected, for example a solar inverter, start the function as described in section 6.9.4.
- Adjust value Irradiance with any rotary knob between 100% (default) and 0%, in order to reproduce different light situations for the simulated panel. The actual values on the display indicate the working point and can show whether the simulation has arrived at the MPP or not.
- Stop the function run anytime as described in section 6.9.4.

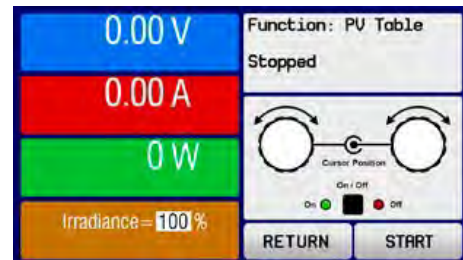

6.12 Remote Control of the Function Generator

The function generator can be remotely controlled, but configuration and control of the functions with individual commands is different from manual operation. Section 7.12.15, “Function Generator Commands” on page 179 explains the approach. In general, the following items apply:

- The function generator is not controllable via the analog interface.
- The function generator is unavailable if R mode (resistance) is activated.
- Some functions are based on the arbitrary generator, some on the XY generator. Therefore, both generators have to be controlled and configured separately.

7 Remote Control Programming

7.1 Overview

All DCS Series units are equipped with a USB device interface for remote control. In addition to this, one digital interface module can be installed at a time as well. See section 3.7.2, “Interface Module Slot” on page 24 for a list of available interface options.

This section covers remote control and programming command syntax for all available digital interfaces.

7.2 General Comments

7.2.1 Interface Startup Times

If you plan to integrate a unit into an existing network or field bus with any of these interfaces installed, keep the following in mind:

- All modules, but especially the Ethernet types which provide a web site, require a certain startup time each time the unit is powered, which will delay their network readiness. Usually, the interface module is ready for communication as soon as the unit is ready for operation.
- The readiness for operation may be indicated by the modules (with one of the LEDs) before the required startup time has run out. If one would try to contact an Ethernet module in order to access the website, the website may not load completely or the browser might stop with a time-out error.

7.2.2 Linear Network Topologies

The Ethernet based modules for standard LAN, ModBus TCP and Profinet/IO are also available in a version with two ports. These provide the possibility to connect multiple units in a linear topology and even to build a ring (DLR, device level ring) for extended safety against interruption. External switches can be eliminated as well as long network cables as needed for a star topology.

The EtherCAT module however, has two ports by default and always builds a ring because of the standard setup of EtherCAT systems. It is also Ethernet based, but cannot be considered as LAN port.

7.2.3 Browser HTTP Access

The Ethernet based modules, standard LAN, ModBus TCP, Profinet, and the integrated LAN ports offer a website function. It is accessible with common browsers (Firefox, Chrome, Safari) by simply entering the IP address or the host name, which has been assigned to the unit. Accessing the website via the host name (default: Client) is only possible if the network runs a DNS or, when using direct connection, the PC runs a DNS and the domain/host name is already registered.

The default IP is **198.168.0.2**. All other required network parameters for the device/network interface can be changed or reset to defaults in the setup menu of the unit.

The currently active IP address, along with other network related parameters like gateway, DNS address, subnet mask and MAC address, can also be read from an overview in the setup menu of unit where the series features an on-screen setup menu.

The website gives the user full control over the unit by manually typing SCPI commands. It primarily serves for simple testing purposes. In case you want to continuously control a unit or at least monitor it, please refer to the SCPI command language section in this manual.

The website's second CONFIGURATION page allows for setting up network specific parameters, same as when doing so from the unit setup menu. These are written to the unit remotely, requiring prior activation of remote control by command SYST:LOCK ON.

7.2.4 TCP Network Access

All interface network modules, as well as the integrated LAN port of select series offer standard TCP access via the default port **5025** (user-selectable, see unit operating guide for setup menu). TCP data transfer is used for the external communication via ModBus RTU or SCPI. Some interface modules feature additional ports, which are reserved and cannot be changed.

The port and other network related parameters can either be adjusted in the unit's setup menu (if featured) or from outside via USB or on the website.

TCP/IP socket connection (IP:port) is intended for normal remote control access to the unit.

Note: The TCP connection is automatically disconnected by the unit after a certain amount of time elapsed with no data transmission. This timeout is by default set to 5 seconds, but can adjusted to higher values. There is also another related option called "TCP keep-alive" which, if activated, turns the timeout ineffective, unless "TCP keep-alive" is not configured in the network.

7.2.5 General Unit Communication

After connecting the unit via a digital interface to a PC, it is usually ready for access. Access can happen in one of several ways:

- Via a control and monitoring software supplied by the unit manufacturer
- Via LabView VIs, supplied by the unit manufacturer
- Via a custom programmed application which is usually created by the user
- Via other software, like a terminal program that can send text messages (SCPI)
- Via internationally standardized software for CAN, CANopen, Profibus or EtherCAT etc.

Control locations are those locations from where a unit is accessed. There are basically two: direct access (manual control) and external access (remote control). The user can switch between control locations just as the situation requires. Refer to section 6.5.2, "Control Locations" on page 102 for more details.

7.2.6 Message timing and command execution time

The timing of communication, more precisely the control over the chronological run of two subsequent messages, is not controlled by unit and is the responsibility of the user.

As a rule of thumb, the unit cannot process incoming messages as fast they can be technically transferred by the interface hardware and its specifications. Thus, it is important to time communication and wait a certain time before the next command is sent, no matter what interface is used. This does not include protocol related data traffic, like it occurs for example between a Profibus slave and its Profibus master, because this traffic is handled by the interface itself, not by the unit.

The following also applies:

- Queries to the units, i.e. commands that read something, are executed faster and may be sent more often and in shorter intervals.
- Write commands, i.e. commands that set a value or a status, are not immediately executed when received and the delay before execution varies.

7.2.6.1 Execution time when writing

Due to different internal design of the series, different types of microcontrollers, which control the hardware and communicate with the PC, and different firmware revisions may affect the time for processing a set value or status command. There is no fixed time between setting a value and the corresponding reaction on the DC output. An average value for current unit situation can be determined by the user with triggering a measurement parallel to a command transfer

7.2.6.2 Response time when reading

Reading something from a unit is usually responded to after a certain response time. There are generally two methods of communicating with a port:

1. Open port -> write query to port -> read response from port -> close port
2. Open port -> write query to port -> read response from port -> repeat write/read x times -> close port

Reading a response from the port is generally required with ModBus, because there could also be an unexpected error message. Using SCPI, reading from the port is only required after query commands, i.e. those ending with a "?".

Both methods have advantages and disadvantages. The primary advantage of method 2 over method 1 is that writing and reading can result in an even faster response time. The primary advantage of method 1 over method 2 is that closing the port also closes the connection which makes communication more stable, especially if the time between two write-read cycles is very long. The values in the table below have been acquired using method 1.

Series	Typical response time
DCS Series 6RL Series	SCPI: via USB <5 ms ⁽²⁾ , via Ethernet <10 ms ⁽¹⁾ ModBus: via USB <5 ms ⁽²⁾ , via Ethernet <10 ms ⁽¹⁾ CAN/CANopen: ≈2 ms

1) Acquired from a measurement of 200,000 command cycles of method 1 via interfaces OPT-ETH1P (Ethernet) and OPT-MBUS1 (standard Ethernet port 5025)

2) Acquired from a measurement of 200,000 command cycles of method 1 via the virtual COM port of the USB driver

Note: The response time of both, USB and Ethernet, may vary depending on the communications module firmware version installed on your unit and can better or worse than listed here.

7.2.6.3 Message Timing

The minimum time between two messages, as listed below, primarily depends on the typical response time as listed in the previous section.

Series	Minimum time between two messages	Recommended time between two messages
DCS Series 6RL Series	USB / CAN / CANopen: 10 ms Ethernet: 15 ms	USB / CAN / CANopen: 20 ms Ethernet: 30 ms

7.3 Communications Protocols Overview

There are two supported protocols: ModBus RTU and SCPI. Both can be used via RS232, USB and most of the Ethernet based interfaces. Exceptions are those related to dedicated standards such as CAN, CANopen, Profibus, Profinet or EtherCAT.

When using a ModBus TCP interface module and depending on the addressed port, there is a distinction between ModBus RTU and ModBus TCP with respect to the message format. The reserved and dedicated port **502** supports only ModBus TCP frames, while all other ports would only support frames with a ModBus RTU or SCPI message.

Note: With option GPIB (GPIB+USB+Analog) installed, only SCPI can be used via GPIB. With USB, ModBus RTU is supported as well.

The integrated USB-B device port located on the rear panel of the unit can be used for both protocols. Which protocol to use is determined by the unit by the first byte of a message, except when using the ModBus TCP protocol. According to the ModBus TCP standard, a six-byte MBAP header is added to any ModBus format message and is usually sent using the dedicated port 502. A SCPI or ModBus RTU message sent to this port would cause a communication error.

Depending on the selection of the interface and the protocol you are going to use, a different section of this manual will be relevant.

Some interface standards, such as Profibus/Profinet, require a different protocol format and transmission scheme towards a bus or network and the interface modules then act as

translators. In this case, the user cannot use any of the default protocols, but is tied to the standard given by the interface specifications.

7.3.1 Supported Protocols by Interface Module

The overview below show which interface module can use which protocol:

Interface	ModBus RTU?	SCPI?	Other protocol
CAN	modified	no	no <i>CAN</i>
CANopen	no	no	CANopen <i>CANopen</i>
RS232	yes <i>ModBus protocol</i>	yes <i>SCPI command language</i>	No
Profibus	no	No	Profibus <i>Profibus & Profinet</i>
Ethernet	yes <i>ModBus protocol</i>	yes <i>SCPI command language</i>	No
ProfiNet	No	No	Profibus <i>Profibus & Profinet</i>
ModBus TCP	yes <i>ModBus protocol</i>	yes <i>SCPI command language</i>	ModBus TCP
EtherCAT	No	no	EtherCAT <i>EtherCAT</i>

Table 7-1: Interface Modules supported Protocols

7.3.2 Remote Control Characteristics

When using remote control via digital interface, some things must be taken into account:

- Configuration or control of the function generator (where available) requires a certain procedure. This is described for ModBus and for SCPI in each respective manual section. The described procedure for ModBus also applies to any other protocol used by buses like CAN, CANopen, EtherCAT etc.
- Some ModBus registers resp. SCPI commands are intended for the setup of the unit same as when doing so manually in the unit setup menu. Those registers/commands are not particularly grouped or marked and should only be used to switch between configurations of the unit.
- The adjustment limits (“Limits”), as adjustable in the unit’s setup menu, limit related set values from every control location, i.e. also in remote control via digital interface. This can lead to unexpected communication errors coming from the unit when a value is too high/low. With SCPI language use, these errors are not returned automatically, because it is typical with SCPI to receive error messages only upon request. In order to be sure whether a set value has been accepted by the unit or not, reading back the set value is the only way to be sure it was accepted.

7.3.3 Fragmented messages on serial transmissions

With RS232, Ethernet or even with USB it is possible, that the unit receives fragmented messages. This means, a command is received in pieces together with a certain time gap and then interpreted by the unit as multiple, but single and incorrect commands. Primarily SCPI commands are affected, because they are strings consisting of ASCII characters and do not have a checksum. Those strings could be sent by a serial interface character by character or as one single block, depending on the situation on the control side (PC). If a certain timeout elapses between two consecutive bytes, the message is considered as "completely received" by the unit, due to the lack of a termination character, which is not generally required for ModBus or SCPI.

A variable USB timeout has been implemented, which can be configured manually on the unit or via remote control, for example via SCPI. If the communication between PC and unit has a lot of communication errors due to possibly fragmented messages, the timeout should be increased incrementally to eliminate the problem. It is advised to keep the timeout setting as low as possible, because at the end of every message the timeout has to elapse before the unit can process the command.

When using SCPI, sending an additional termination character (typical LF, CR, or CRLF accepted), which is not required but accepted, will terminate the timeout immediately and let the unit consider the message as completely received, so it can be processed.

7.3.4 Connection Timeout

Socket connections to units which support an Ethernet port have a connection timeout. This variable and user-adjustable timeout closes the socket connection automatically on the device side if there was no communication going on between device and controlling unit (PC, PLC etc.) for the adjusted time. After the socket has been closed, connection can be established again at any time.

7.3.5 Effective Programming Resolution

All values related to voltage, current, power and resistance, that can be transferred to the unit and which are transferred via the power stages to the output of the unit have the same defined programmable resolution and an effective resolution. While the programmable resolution of a value is the same for every series (0-100 % = 0 - 0xCCCC = 0 - 52428), even when using SCPI, the effective resolution depends on the ADC/DAC used in the hardware which is 16 bits for the DCS Series.

The effective resolution determines the doable step width on the DC output/input. It calculates as $\text{step width} = \text{rated value} \div \text{effective resolution}$. For DCS80-510 model, the approximate step width of voltage is $80 \text{ V} / 26214 = \sim 3 \text{ mV}$. For the current it would be $510 \text{ A} / 26214 = \sim 19 \text{ mA}$.

However, tolerances add to the result when setting a value. The DCS80-510 from the example above has a voltage tolerance of max. 0.1%, as stated in this manual. This is up to 80 mV. When setting, for example, 24 V the true output voltage is allowed to be within 23.92 V to 24.08 V range. The actual value, as readable from the unit, already includes this

tolerance (or error). If you would measure the actual output voltage with an external multi-meter and it would read 24.03 V and you would want to have closer to the desired 24 V, the software could adjust the set value down by 30 mV (one step) or use the minimum step width of ~3 mV to approach the target voltage in several steps.

7.4 Function Generator Minimum Slope

When programming the arbitrary generator, no matter what digital interface is used, the unit may return errors related to the values in the sequence points. Besides obvious errors like "value out of range", there is also a minimum slope to respect.

All sequence points have an AC part, which is only used to generate sine waves, and a DC part with a start and value. When start and end value are different, a slope is generated. This is normal in functions for ramp, triangle and trapezoid.

That slope ($\Delta U/t$ or $\Delta I/t$) must fulfil a specific minimum value. In order to check if a certain rise/fall over time is feasible, the minimum slope should be calculated for the rated values of your particular unit.

Formula: min. slope = 0.000725 * rated voltage or current ÷ s.

In relation to the parameters you set up for a sequence point, the unit calculates the slope in the sequence point from "Start value of DC part", "End value of DC part" and "Sequence time" and compares it to the min. slope.

Example: For a DCS supply with 500 V and 30 A rating in CC Mode. A rising ramp on the current will be generated. The min. slope calculates as: $\Delta I/t = 0.000725 * 30 A = 21.75 \text{ mA/s}$. If you wanted to do ramp of 0-20 A in 5 s, the slope would be 4 A/s, which is OK and doable. However, the same 0-20 A over 20 minutes is not possible and would be rejected by the unit.

The max. time for a certain ΔU or ΔI can be calculated: $t_{\text{Max}} = \Delta U \text{ or } \Delta I \div \text{min. slope}$. For the above example with 0-20 A we get a $t_{\text{Max}} = 20 A / 0.02175 A/s = \sim 919$ seconds.

Conclusion: long-time ramps over many minutes or even hours cannot be achieved using the function generator, but by using an alternative method, which is setting a certain number of steps over time using a PC software.

Here the effective resolution comes into play. The DC supply from the example above could be a DCS80-170 with a programmable resolution of 52428 steps and an effective resolution of 26214 steps. Let's focus on the 26214. It represents 0-100% = 0-170 A when working on the current. For 0-113 A it would then be 17476 steps. If you wanted to generate the 0-113 A ramp over 10 hours, you could set a new value every $10 \text{ h} / 17476 = \sim 2$ seconds, while the value increases with every step by $113 A / 17476 = \sim 6.48 \text{ mA}$.

7.5 ModBus Protocol

7.5.1 Preface

Before referencing this section, make sure the interface module option installed in the power source supports the ModBus protocol.

The DCS Series are always ModBus slaves with address zero (0). This setting cannot be changed.

7.5.2 General ModBus RTU Information

A telegram (or message) as defined by the ModBus RTU protocol consists of hexadecimal bytes, of which the first byte, the ModBus address, must always be 0. The first byte of a telegram is used to distinguish the telegram between ModBus and SCPI. A value between 1 and 41 in the first byte will cause a ModBus communication error, whereas from 42 (ASCII character: *) the telegram is interpreted as a text message or SCPI command.

Format and length of a telegram are defined. The telegram has to be transmitted according to the specifications of the particular interface that is used. Normally, the user only has to ensure a correct message, rather than correct transmission. But there are also interfaces, like for example RS232, which do not feature communication protocol handling and do not guarantee transmission. Other interfaces support guaranteed correct transmission by using a check-sum and/or software handshaking.

7.5.3 General ModBus TCP Information

The message protocol according to ModBus TCP/IP standard (short: ModBus TCP) is only available with the ModBus TCP 1-Port and 2-Port interface modules and only via the default ModBus TCP port **502**. By definition, a ModBus TCP message requires an additional header of 6 or 7 bytes, compared to ModBus RTU. This makes it impossible to use SCPI commands via this port. The rest of the message is identical to ModBus RTU, except for the checksum at the end, which is not necessary with ModBus TCP. Information about the header can be found below. The following sections are related to the core part of ModBus messages, which is identical for both protocols. Also see section 7.10, "ModBus TCP Details" on page 151 for details.

7.5.4 Format of set values and resolution

Set values, as transmitted via digital interfaces, are always percent values of the unit's nominal values (U, I, P, R) and correspond at 100% to the hexadecimal value 0xCCCC (decimal: 52428). The total usable range is 0%...102% (0x0000...0xD0E5). The register lists for a particular series defines the range for all settable values.

It means, you can set a percent value between 0% and 100% by sending hexadecimal values of 0x0000-0xCCCC resp. for supervision thresholds of unit alarms like OVP it will be 0x0000-0xE147 for 0% to 110% or on some series 0x0000-0xD2F1 for 0 to 103%.

This means 52429 possible values for 0-100%. This is internally halved (bit 16 is reserved for sign) **and so the usable resolution results in 26214.**

7.5.5 Translating Set values to Actual values

Real values have to be translated to their percent equivalent values before being transmitted them to the unit. Values read from the unit are also in percent and must be translated into real values in order to process them further. In all cases, 0xCCCC (hexadecimal) = 52428 (decimal) = 100% nominal value (U, I, P).

Translation is done by implementing these formulas into your software.

Per cent value to real value	Real value to per cent value
$\text{Real value} = \frac{\text{Nominal device value} * \text{percent value}}{52428}$ <p>Example: The nominal voltage of your unit is 80 V and the percent- aged actual voltage was read as 0x2454 = 9300. According to the formula above, the real actual value will be $(80 * 9300) / 52428 = 14,19$ V.</p>	$\text{Percent value} = \frac{52428 * \text{real value}}{\text{Nominal device value}}$ <p>Example: the power set value shall be 3150 W, the nominal power of your unit is 3500 W. According to the formula above we get: Power set value = $(52428 * 3150) / 3500 = 47185 = 0x8851$.</p>

Note: All set values are not only limited by the unit’s nominal values, but can also be limited by the adjustable “Limits” (where available). Values exceeding the minimum or maximum of the adjusted range are rejected by the unit.

Note: When translating real values into percent values (decimal or hexadecimal), it is often required to round up or down. We recommend to round naturally. Natural rounding can result in a translation value, which is 1 higher than expected

7.6 USB Communication

After connecting the unit via USB cable and successful USB driver installation, the unit is ready for access. The COM port, which is assigned to the new USB device (see Windows device manager) does not need configuration. It is based upon a so-called CDC driver (Communications Device Class), which is available for Windows XP and 7 (also Embedded) and for other operating systems, too. This driver generates the COM port for simplicity and can run data transmissions as fast as USB 2.0 can handle it. The typical serial settings are not effective and are ignored.

7.6.1 USB driver installation

The USB driver for the rear panel USB device port type B is available for download from the APS website or included with the unit on a USB memory stick. It installs as a signed driver for virtual COM ports on 32 bit or 64 bit Windows operating systems Windows 7 or newer.

7.6.2 First steps

In order to communicate with the unit, the software used on the PC must be able to open a COM port and send messages in either binary (ModBus protocol) or ASCII strings (SCPI) format.

For SCPI mode, a simple terminal program suffices. For binary telegrams in hexadecimal format, other tools are required, like Docklight (<https://docklight.de/>). Those can help to see how the communication works correctly or at all.

To finally establish communication and access the unit via USB, you need to:

1. Connect the unit via USB (alternatively via any other digital interface).
2. Install the USB driver (see 4.6.1).
3. Run a terminal program.

Note: In order to control a unit, i.e. changing values or status by switching, the DC output on or off, it is required to activate remote control first. This does not happen automatically when sending the very first command.

Note: Switching to remote control may be blocked by the unit. When using SCPI language, the unit never returns error messages automatically, but only upon an error query command request.

7.7 Other Digital Interface Communication

The Profinet/IO module (1 or 2 ports) can be used to control and monitor a unit using a network system, usually combined with an integrated PLC and proper software. For Profinet, the software selects the necessary Ethernet port, because this port cannot be adjusted on the unit. The standard Profinet communication is different and is handled by the field bus protocol via special software.

7.8 Register Lists

Along with this manual, there are register lists (one for each model series) available as PDF files. These provide an overview of the remote programming features that are available for a certain model series when using binary communication protocols like ModBus.

These lists differ in the number of available registers, i.e. commands. They are primarily made for ModBus protocol communication, but are also a reference when controlling a unit via a **field bus** (CAN, CANopen, Profibus, Profinet, EtherCAT) or accessing it in programming environments like **LabView** or **MatLab**, for example when trying to interpret values or to understand the function of a certain command.

The lists explain in compact format how the data in a binary message has to be interpreted or how a register (with CANopen resp. EtherCAT it is called "index") is specified. This will help the user to implement the unit communication into custom software applications. Users who

decide to work with SCPI command language usually do not need those lists. Later in this document, the SCPI commands are referenced in a separate chapter.

Columns with information provide in these lists are:

Data Type

Following data types are used.

Data type	Length	
char	1 Byte	Single byte, used for strings
uint(8)	1 Byte	Single byte
uint(16)	2 Bytes	Double byte, also called word or 16bit integer
uint(32)	4 Bytes	Double word, also called long or 32bit integer
float	4 Bytes	Floating point value according to IEEE745 standard

Access

This column defines for every register whether the access is read only, write only or read/write.

R = Register is read only

W = Register is write only resp. would not return a reasonable value when read from

RW = Register can be read or written

It applies generally: Writing to a register, which allows write) access (W, RW) is only possible during remote control!

Number of registers

With ModBus, a register always has a length of 2 bytes or a multiple of 2 bytes. This column tells how many 2-byte values are used by the register. The value is always half that of the value in column "Data length in bytes".

Data

This column tells additional information about the data which can be written to or read from the register. Two, four or more bytes can be interpreted in different ways, depending on data type and content.

Profibus/Profinet slot & index

These columns (where available) are used by Profibus/Profinet users to link the registers in the register list via two values "index" and "slot" to data blocks (SFBs) in the PLC software. While "index" is a direct parameter for the data block, the value "slot" has to be used to find the address of a slot, which is variable, in order to get the parameter "ID". For more see section 7.5, "ModBus Protocol" on page 140.

EtherCAT SDO/PDO?

This column is only available in register lists for those models which support the EtherCAT interface.

The column marks which of the generally per unit available ModBus registers can be accessed by the CANopen over Ethernet (CoE) protocol in form of indexes. Some of the marked registers are connected to PDOs, the rest is connected as SDOs. Units supporting the EtherCAT interface contain a downloadable data object list. Which of the registers connect to PDOs is described in the EtherCat section of this manual.

7.9 ModBus RTU Details

This protocol can be used with the USB-B interface (where available) and with most of the optionally available interface modules. The addressed information when using ModBus protocol is also called a register. This document uses the terms **address**, **register** or **register address**.

Message Types

The message system distinguishes between query messages, control messages and response messages. Query messages will cause the unit to send a response message, while control messages only cause it to reply with a 1:1 echo, in order to confirm reception.

General

The units also support the text based SCPI language, with automatic detection of the used protocol. When using ModBus, the first byte of every message has to be zero.

Functions

The second byte of a message contains a ModBus function code (FC, marked blue below), which determines whether the message is a READ or WRITE message. It also determines, whether one or multiple registers are accessed. The protocol, as described below, supports following ModBus functions (Date: 07-13-2018):

Function		Function name		Description	Example of use
Hex	Dec	Long	Short		
0x01	1	READ Coils	RSC, RC	Always reads 1 bit, but is returned as a full register with a 16-bit value. For example, the value 0xFF00 means "logic 1" or TRUE. <u>At this point, it is different from the ModBus standard and may cause problems with ModBus software tools.</u>	Query the input / output condition
0x03	3	READ Holding Registers	RHR	Used to read <i>n</i> subsequent registers. Results in <i>n</i> *2 bytes of data in the response message.	Read the model name string (1-40 bytes)
0x05	5	WRITE Single Coil	WSC	Used to write 16 subsequent bits which are interpreted as 1 bit (TRUE or FALSE). <u>At this point, it is different from the ModBus standard and may cause problems with ModBus software tools.</u>	Switch unit to remote control.
0x06	6	WRITE Single Register	WSR	Used to write one register.	Set values (U, I, P etc.)

Function	Function name	Description	Example of use
0x10	16 WRITE Multiple Registers	WMR Used to write n subsequent registers. Used to write beyond the limits of a register block, for example when trying to write multiple set values (U, I, P) at once.	Write multiple values at once within a register block or write the so-called user text.

Table 7-2: ModBus RTU Functions

Note: The register list defines which of the above functions may be used with every register.

Note: The bytes in a ModBus message are read from left to right (big endian format), except for the 16 bit ModBus checksum where low byte and high byte are switched.

7.9.1 Control Message (write)

When sending a status, a value, multiple values or a text, the data part of the message requires to define at least the target register and one value to write. The protocol checks the message only regarding the max. length of the register. After the data part, the checksum is expected. So in case the data part would only contain the minimum two bytes and thus the message would fulfil the protocol requirements for the selected function code, the checksum would be expected at the position of the 7th byte. If there were further data bytes at that position or zeros and the checksum would be at a different position in the message, the unit would return an error. Hence, the unit will return an error, no matter if the telegram is too short or too long, because the checksum is wrong. For message examples see section 7.9.5, “Examples of ModBus RTU messages” on page 148.

WRITE Single Register:

Byte 0	Byte 1	Bytes 2+3	Bytes 4+5	Bytes 6+7
Addr	FC	Start reg.	Data word	CRC
0x00	0x06	0...65535	Value to write	Checksum ModBus-CRC16 ⁽¹⁾

WRITE Multiple Registers:

Byte 0	Byte 1	Bytes 2+3	Bytes 4+5	Byte 6	Bytes 7-253	Last 2 Bytes
Addr	FC	Start reg.	Number	Count	Data bytes	CRC
0x00	0x10	0...65535	0...123	Number*2	n values to write	Checksum ModBus-CRC16 ⁽¹⁾

Write Single Coil:

Byte 0	Byte 1	Bytes 2+3	Bytes 4+5	Bytes 6+7
Addr	FC	Register	Data word	CRC
0x00	0x05	0...65535	0x0000 (FALSE) or 0xFF00 (TRUE)	Checksum ModBus-CRC16 ^(1,2)

Note: The entire 16 bits of the data word represents 1 coil only, for writing and reading.

¹ See ModBus Checksum

7.9.2 Response Message (read)

A response from the unit is usually expected after a query or if something has been set and the unit confirms the execution.

Expected response for WRITE Single Register:

Byte 0	Byte 1	Bytes 2+3	Bytes 4+5	Bytes 6+7
Addr	FC	Start reg.	Data	CRC
0x00	0x06	0...65535	Written value echoed	Checksum ModBus-CRC16 ⁽¹⁾

Expected response for WRITE Single Coil:

Byte 0	Byte 1	Bytes 2+3	Bytes 4+5	Bytes 6+7
Addr	FC	Start reg.	Data	CRC
0x00	0x05	0...65535	Written value echoed	Checksum ModBus-CRC16 ⁽¹⁾

Expected response for WRITE Multiple Registers:

Byte 0	Byte 1	Bytes 2+3	Bytes 4+5	Bytes 6+7
Addr	FC	Start reg.	Data	CRC
0x00	0x10	0...65535	Number of written registers	Checksum ModBus-CRC16 ⁽¹⁾

Expected response for READ Holding Registers:

Byte 0	Byte 1	Byte 2	Bytes 3-253	Last 2 Bytes
Addr	FC	Data length in bytes	Data	CRC
0x00	0x03	2...250	Queried registers content	Checksum ModBus-CRC16 ⁽¹⁾

Expected response for READ Coils:

Byte 0	Byte 1	Byte 2	Bytes 3+4	Bytes 5+6
Addr	FC	Data length in bytes	Data	CRC
0x00	0x01	2	Queried bit as 1 register (always 16 coils)	Checksum ModBus-CRC16 ⁽¹⁾

Unexpected response (communication error):

Byte 0	Byte 1	Byte 2	Last 2 Bytes
Addr	FC		CRC
0x00	Function code + 0x80	Error code	Checksum ModBus-CRC16 ⁽¹⁾

Note: A communication error can have several reasons, like a wrong checksum or when attempting to switch a unit to remote control that has been set to “Local” or if it is already remotely controlled by another interface. See the communication error code list in section 7.9.4, “Communication Errors” on page 147.

7.9.3 The ModBus Checksum

The checksum at the end of ModBus RTU messages is a 16 bit checksum, but is not calculated as the usual CRC16 checksum. Furthermore, the byte order of the checksum in the message is reversed. Information about ModBus CRC16 and source code for implementation and calculation are available on the Internet, for example here:

<http://www.modbus.org/>

Sample C Code:

```

// Compute the MODBUS RTU CRC
UInt16 ModRTU_CRC(byte[] buf, int len)
{
    UInt16 crc = 0xFFFF;

    for (int pos = 0; pos < len; pos++) {
        crc ^= (UInt16)buf[pos];           // XOR byte into least sig. byte of crc

        for (int i = 8; i != 0; i--) {    // Loop over each bit
            if ((crc & 0x0001) != 0) {  // If the LSB is set
                crc >>= 1;              // Shift right and XOR 0xA001
                crc ^= 0xA001;
            }
            else                          // Else LSB is not set
                crc >>= 1;              // Just shift right
        }
    }
    // Note, this number has low and high bytes swapped, so use it accordingly (or swap
    bytes)
    return crc;
}

```

7.9.4 Communication Errors

Communication errors are only related to digital communication with the unit. Other alarms or errors of any kind, which can be generated and indicated by the unit itself must not be mixed up with these communication protocol generated errors.

The unit will return unexpected error messages in case the previously sent message is in wrong format or if the function cannot be executed by some reason. For example, when trying to write a set value with WRITE SINGLE REGISTER while the unit is not in remote control. In this case, the message is not accepted and the unit will return an error message instead of a confirmation message. The message format can be wrong if the checksum is bad or if you try to read a bit with function READ Holding Registers instead of READ COILS.

In case of an error, the response message contains the original function code added to 0x80, in order to identify the response as error message.

Overview of function codes in error messages:

FC error	Belongs to
0x81	READ COILS
0x83	READ HOLDING REGISTERS
0x85	WRITE SINGLE COIL
0x86	WRITE SINGLE REGISTER
0x90	WRITE MULTIPLE REGISTERS

Overview of the communication error codes, which can be returned by the unit:

Code	Error	Explanation
0x01	1 Wrong function code	The function code in byte 1 of the ModBus message is not supported. See section 7.9 Functions for supported codes. The error also occurs when trying to read or write a register with a function code for which the register is not defined.

Code	Error	Explanation
0x02	2 Invalid address	The register address you were trying to access with read or write is not defined for your unit. Every model series may have a different number of registers. Refer to the separate ModBus register list of the series your unit belongs to.
0x03	3 Wrong data or data length	The length of data in the message is wrong or the data itself. For example, a set value always requires two bytes of data. If the data part of the message would be one byte only or three bytes, then the data length would be wrong. Otherwise, when sending a set value of, for example, 0xE000 to a register for which the maximum value is defined as 0xCCCC, this would be wrong data.
0x04	4 Execution	Command could not be executed, depends on the situation
0x05	5 CRC	The CRC16 checksum at the end of the ModBus RTU message is wrong or has been transmitted in wrong byte order (high byte first instead of low byte)
0x07	7 Access denied	Access to a certain register is not allowed or read only while trying to write, or vice versa. The error also occurs when trying to write to a writable address while the unit is not in remote control or in remote control from a different interface
0x17	23 Unit in local	Indicates, that write access to the unit is blocked by the "local" condition, so only read access is possible. "Local" means that remote control is not allowed.

An example: You attempted to switch the unit to remote in order to control it from PC, but instead of an echo of your message, it returns something like this: 0x00 0x85 0x07 0x52 0x92. This is an error message. The position of the function code contains the value 0x85. According to the first table above, this is related to the function WRITE SINGLE COIL. The error code in the message is 0x7 which means, according to the second table above, the unit has denied the access. This can have different reasons, for example that the unit is already in remote control via a different interface.

7.9.5 Examples of ModBus RTU messages

These examples can also be used for ModBus TCP, but they need to be extended by the required ModBus TCP header and stripped from the unnecessary checksum.

1) Writing a Set value

Set values are adjustable limits for the physical values Current, Voltage, Power and Resistance (where available). They can only be written to a unit if it has been switched to remote control before via a digital interface.

Example: You want to set the current to 50%. According to the register lists, the “Set current value” is at address 501 (0x1F5) and assigned function is WRITE Single Register. Expecting the unit be already in remote control mode, the message to build then has to be like this:

Addr	FC	Start	Data	CRC
0x00	0x06	0x01F5	0x6666	0x325F

Response:

Addr	FC	Start	Data	CRC
0x00	0x06	0x01F5	0x6666	0x325F

In this case, the unit is expected to return an echo of your message, indicating successful execution of the command. The display of the unit should now show 50% of the maximum current of your unit. For a power supply with 510 A nominal current, it should show 255.0 A or for a model with 170 A current rating, it should show 85 A.

2) Query all actual values at once

The unit holds three readable actual values of voltage, current and power. Electronic loads feature an additional actual resistance value in their displays, which cannot be read via interface, but is calculated from the actual voltage and current. Hence, the user can calculate the actual resistance himself.

Actual values can be queried separately or all at once. The advantage of a combined query is that you gain a snapshot of the most recent actual values of the DC output. When querying separately, values may have changed already when sending the next query.

According to the register list, the actual values start from register 507. Three registers shall be read:

Addr	FC	Start	Data	CRC
0x00	0x03	0x01FB	0x0003	0x7417

Possible Response:

Addr	FC	Len	Data	CRC
0x00	0x03	0x06	0x2620 0x0C9B 0x091B	0x9EC0

3) Read the nominal voltage of a unit

The nominal voltage, like the other nominal values of current, power or resistance, is an important value to read from a unit. They are all referenced for translating set values and actual values. It is recommended to read them from the unit right after opening the digital communication line, or the software will not be universal.

According to the register list, the nominal voltage is a 4-byte float value in register 121.

Addr	FC	Start	No.	CRC
0x00	0x03	0x0079	0x0002	0x1403

Possible Response:

Addr	FC	Len	Data	CRC
0x00	0x03	0x04	0x42A00000	0xFE9

4) Read Unit Status

All units report their status in a register, for the DCS Series, this is register 505.

Addr	FC	Start	No.	CRC
0x00	0x03	0x1F9	0x0002	0x1417

Possible Response:

Addr	FC	Len	Data	CRC
0x00	0x03	0x04	0x00000483	0xA992

See also section 7.9.2. The response contains the value 0x483, which states that the unit is in remote control via the USB port, that the DC output is switched on and that CC (constant current) mode is active.

7.9.5.1 Switch to Remote Control or back to Manual Control

Before you can control a unit from remote, it is required to switch it to remote control. This is done by sending a certain command.

Notes:

A DCS unit will never switch to remote control automatically and cannot be remote controlled while in this condition. Reading status and values is always possible.

The unit will never exit remote control automatically, unless it is switched off or the mains supply is otherwise interrupted. Remote control can be exited by a certain command. It then switches back to manual control.

Switching to remote control may be inhibited by several circumstances and is usually indicated by an error message:

- Condition “Local” is active (check the display on the front of your unit or read the device status), which will prevent any remote control
- The unit is already remotely controlled by another interface
- The unit is in setup mode, means the user has accessed the setup menu and not left it yet.

How to Switch a Unit to Remote Control:

- 1) If you are using the ModBus RTU protocol, you need to create and send a message according to the description above, for example 00 05 01 92 FF 00 2D FA
- 2) Once the switchover to remote control has been successful, the unit will usually indicate the new condition in the display, as well as it echoes the message as a confirmation

In case switching to remote control would be denied by the unit, because option “Allow remote control = No” is set, then the unit will return an error message like 00 85 17 53 5E. According to ModBus specification, this is error 0x85 with error code 0x17.

Leaving remote control can be done in two ways, one of which is using the dedicated command or by switching the unit to “**Local**” condition.

How to Exit Remote Control:

If you are using the ModBus RTU protocol, you need to build and send a message according to the description above, for example 00 05 01 92 00 00 6C 0A.

7.10 ModBus TCP Details

ModBus TCP is based upon ModBus RTU and this section is only about the differences. The core of a ModBus TCP message is ModBus RTU. Refer to section 7.9, “ModBus RTU Details” for more information. Differences in ModBus TCP compared to ModBus RTU are:

- The message requires an additional 6 bytes long MBAP header
- The checksum is omitted
- It can only be sent via port 502 and only with ModBus TCP interface modules. The port is reserved and must thus not be adjusted in the setup MENU of your unit where you define the port for standard TCP connections.

As a result, Modus TCP messages are always 4 bytes longer than ModBus RTU messages (byte 0 of the RTU message is replaced by the actual 7th byte of the additional MBAP header).

The MBAP header is specified like this:

Bytes	Meaning	Explanation
0 + 1	Transaction identifier	This identifies the message. It is copied by the unit in the response and is used to identify a certain message in a pool of incoming transmissions if multiple units are communicating with the PC and the response is not immediately. The identifier is an arbitrary value between 0 and 65535.
2 + 3	Protocol identifier	Here always 0 = ModBus protocol
4 + 5	Length	Number of remaining bytes in the message, i.e. the length of the ModBus RTU core message minus 2.

7.10.1 Example of ModBus TCP messages

The example is a query for reading the unit’s nominal voltage. Reads holding registers extended by the MBAP Header (arbitrary transaction identifier 0x4711 used):

Query Message

MBAP header	Addr	FC	Start	Data
0x4711 0x0000 0x0006	0x00	0x03	0x0079	0x0002

Possible Response

MBAP header	Addr	FC	Length	Data
0x4711 0x0000 0x0007	0x00	0x03	0x04	0x42A00000

The response contains a floating point value in “Data”, which translates to 80(V).

7.11 Information on Specific Registers

Many of the commands and register related options are self-explanatory, but not all of them. Some of those that are not are described in this section.

7.11.1 Register 171

This allows to write and read an arbitrary string of up to 40 characters, which can be used to uniquely identify a unit amongst multiple units of the same model. It is permanently stored after being written.

7.11.2 Register 408

This register defines the condition of the DC output resp. DC input after the unit has been powered. Register 408 is connected to the MENU setting "DC input after power on" (electronic loads) resp. "DC output after power on" (power supplies). For units without a setup menu this can only be configured via remote control.

7.11.3 Register 411

Described for SCPI "Commands for alarm management" in section 7.12.16, "Alarm Management Commands" on page 184.

When using ModBus, this register is intended to reset alarm bits as represented in the unit status (register 505, see below). Until these are not reset, which is considered as an acknowledgement, the bits from previously occurred alarms remain set, even if the alarms are gone already. Alarms which are still present while register 411 is used to reset the alarm bits will be excluded from resetting. There is an exception: the unit alarm OT (bit 19, over temperature). This will be cleared automatically once the unit has cooled down. After resetting the alarm bits, unit alarms can only be read in form of an alarm counter (registers 520 - 524).

7.11.4 Registers 500-503 (Set values)

These are the most important registers to work with, because they define the DC output values of voltage, current, power and resistance (where featured). With ModBus, any set value is transmitted as percent value of the nominal unit values (0...100%), whereas for SCPI real values are used.

Generally, before you can use R mode on unit where internal resistance mode, it has to be activated (register 409), else the set value is ignored.

In PV function mode, the set value for current (register 501) is interpreted as irradiation value, as long as the unit is in "PV mode". While the function is running, this register does not define the current limit for the unit, but a parameter called irradiation, which is commonly used in solar panel simulation. In manual operation, irradiation can be adjusted in 1% steps between 0% and 100%. With the set value of current it is also 0-100%, according to definition of register 501, but with a significantly higher resolution.

7.11.5 Register 505 (Device status)

This is an important register as it represents the device condition in one 32-bit value (ModBus). Some bits are grouped and have to be interpreted as such. According to the register list, bits 0-4 of registers 505 are a group that represents the so-called control location. By reading this register you can furthermore detect if the unit is already in remote control to see if command "Remote mode = on" was executed by the unit.

With SCPI, some but not all of these 32 bits of this register are represented in the status registers "Questionable" and "Operation". See SCPI section under registers.

When running master-slave

During master-slave operation (where featured), the status register uses bit 29 ("MSS") to indicate the so-called master-slave safety mode, which is activated every time the master detects any problem in the communication with the slave(s), which can occur due to a connection failure or heavy electrical interferences. The master unit will then set this bit and switch off all DC outputs/input of the slaves being still online. Offline slaves will put themselves into a similar state and switch off DC.

After removal of the problem cause, the MS system has to be re-initialized, which also clears the bit.

7.11.6 Registers 650 - 662 (Master-slave configuration)

This block of registers is used to configure the master-slave operation mode (short: MS) the same as you can do it in the setup MENU of your unit. Refer to the unit's operating guide about how the MS works and what do to in preparation of its remote control. For remote control of a MS system, it is expected to be fully wired. Before MS operation, slave units can be configured remotely, but during MS operation they can only be monitored, if required. It is recommend to only control the master unit. Configuration and activation of MS operation can also be done manually and remote control can be taken over later after the master has initialized the system.

With the MS system not being set up yet, these registers have to be used in a certain order on any unit:

1. Switch to remote control with register 402.
2. Activate MS operation mode with register 653.
3. Select with register 650 whether the unit you are configuring will be Master or Slave. Further steps, only to be performed on the master unit:
4. Initialize the MS system with register 654.
5. (with electronic loads only and also only required when running two-quadrants operation) Set the unit to be Share bus slave (else it would be master) with register 652.
6. Optional: check with register 655, whether the initialization has been successful.
7. Optional: Query the number of initialized units with register 662 --> in case the number does not match the units you want to use in the MS system, check the settings of all units and the cabling and repeat the initialization.

8. Optional: read the nominal values (registers 656-660) of the previously initialized MS system to be used as value translation reference while running the MS.

Note: The units support reading the ratings of voltage, current, power and resistance even in MS mode via registers 121 - 129, so registers 656, 658 and 660 are actually obsolete. Alternatively they can still be used, but without the option to read the max/ min resistance of the MS system. This is circumvented by reading the rated values from the master and dividing it by the number of included units.

9. Optional: configure alarm thresholds, event thresholds and set value limits.

During MS operation, the remotely controlled master unit can be accessed like a single unit, with a few exceptions. Set values and actual values are always per cent values related to certain nominal values. Access to those registers is described in the other sections.

7.11.7 Registers 850 - 6695 (Function generator)

The integrated function generator is a complex feature. It is configured and loaded using many registers. Before you can run a function, setup is required every time and in a specific order.

First, you need to decide which one of the two basic function generators you want to use: arbitrary or XY. All further steps depend on this selection.

All function generator settings and loaded data (sequences, XY table) are not stored inside the unit and have to be loaded into the unit every time before you can use the function generator. These data and settings are completely separate from what you can setup and define for the function generator manually when using the control panel and touch display.

7.11.7.1 Procedure for the arbitrary generator

This generator is used to create wave functions like sine, square, triangle or trapezoidal.

1. Select whether to apply the function to the voltage U (register 851) or the current I (register 852). Before you have not made this selection, the unit cannot accept sequence data, because the sequence data is run through a plausibility check against the unit's nominal values.
2. Define start sequence (register 859), end sequence (register 860) and number of cycles of that sequence block to repeat (register 861).
3. Load data for the sequences (x out of 99) you want to use (registers 900-2468, 8 values per sequence point).
4. Set global voltage limit (register 500), if the function is applied to the current. Else set global current limit (register 501), if the function is applied to voltage. Set global power limit (register 502) for both modes.
5. Control the function generator with start/stop (register 850).
6. When finished, leave the function generator by deselecting your former selection of either U (register 851) or I (register 852) again.

7.11.7.2 Programming example for the arbitrary generator

Before you can configure the arbitrary generator for a ramp, it is necessary to think about the best way to achieve the ramp generation. It is important to keep in mind that the arbitrary generator stops at the end of the function run, unless you set the repetition to infinite. After a stop, the DC output remains switched on. In case of a ramp, this is wanted, because the end value shall usually remain set for time x. However, the unit will go to static mode again, setting the static set values of U, I and P. The static values also apply for the period before the function run and for situations when the DC output is already switched on.

The stop action and the static values are thus a little problematic for the ramp function. Why? Supposed, you wanted to have a power supply generate a ramp starting from 0 V. The static value for U (voltage) would then be set to 0. However, after the function stop, the unit would also set 0 V and the voltage would drop from whatever value has been set during the function run. Conclusion: the static value of voltage has to be part of the function.

In order to achieve this, the function has to consist of two parts: one for the rising or falling ramp and the other for the static value. This can be done using two sequences of the arbitrary generator.

Assumption: you have a power supply and the ramp shall start from 0 V and rise to 50 V within 6 seconds. The end voltage shall remain constant for 3 minutes (the time can be varied at will). Sequences 1 and 2 will be used. Remote control is already active, we only need to configure the sequences. Since the ramp will make the voltage rise linearly, using only the DC part of a sequence, the parameters for the AC part (indexes 0 - 4) should be set to zero in order to avoid remainders which could disturb the correct wave generation.

The first step is to activate function generator mode, in this case we select arbitrary generator for U:

Addr	FC	Start	Data	CRC
0x00	0x05	0x0353	0xFF00	0x7DBE

Next step is to create the ModBus message to configure sequence 1, the rising ramp. According to the register list start register 900 (WMR, function code 0x10) is assigned to sequence 1. Because the data part would not fit the width of this document's page size, the 8 float values are below each other:

Addr	FC	Start	Regs	Bytes	Data	CRC	Description
0x00	0x10	0x0384	0x10	0x20	0x00000000		Start value of AC part: 0 V
					0x00000000		End value of AC part: 0 V
					0x00000000		Start frequency of AC part: 0 Hz
					0x00000000		End frequency of AC part: 0 Hz
					0x00000000		Start angle of AC part: 0°
					0x00000000		Start value of DC part: 0V
					0x42480000		Start value of DC part: 50V
					0x4ab71b00		Rise time in μ s: 6,000,000 (6 seconds)

After this, the ModBus message to configure sequence 2, the static voltage would be next. Start register here is 916:

Addr	FC	Start	Regs	Bytes	Data	CRC	Description
0x00	0x10	0x0394	0x10	0x20	0x00000000		Start value of AC part: 0 V
					0x00000000		End value of AC part: 0 V
					0x00000000		Start frequency of AC part: 0 Hz
					0x00000000		End frequency of AC part: 0 Hz
					0x00000000		Start angle of AC part: 0°
					0x42480000		Start value of DC part: 50V
					0x42480000		Start value of DC part: 50V
					0x4d2ba950	0x6AD7	Sequenz time in µs: 180,000,000 (180 seconds = 3 minutes)

As the last step, configuration of the arbitrary generator itself:

Addr	FC	Start	Data	CRC	Description
0x00	0x06	0x035B	0x0001	0x384C	Register 859, WSR, Start sequence: 1
0x00	0x06	0x035C	0x0002	0xC98C	Register 860, WSR, End sequence: 2
0x00	0x06	0x035D	0x0001	0xD84D	Register 861, WSR, Sequence cycles: 1

Now the entire function setup is complete and the function can be started. If the DC output of your unit is OFF when starting the function, it will automatically switch on. Alternatively, you could switch it on separately with the corresponding command before running the function. In this case this is not necessary, because the voltage shall start to rise from 0 V. In other situations where the starting voltage is not zero, it is necessary to switch on the DC output first and wait for the output voltage to settle.

For the number of sequence cycles, 1 is sufficient, but it can be changed at will. The whole function would be repeated after 3 minutes and 6 seconds. The voltage would not instantly drop to 0 V at the end of the first function run and before the second one starts. It depends on the load how long the voltage takes to drop and the ramp, when being graphically recorded on an oscilloscope, could look different than expected. This can be circumvented by adding a third sequence which only uses some time to allow the voltage to go down.

Addr	FC	Start	Data	CRC	Description
0x00	0x05	0x0352	0xFF00	0x2C7E	Register 850, WSC, Run function

7.11.7.3 Procedure for the XY generator

1. Select, whether the function UI (including FC function, register 854) or IU (register 855) or PV (register 426) shall be applied to the DC output of your unit. Before you make this selection, the unit cannot accept XY table data, because that data is run through a feasibility check.
2. Load the XY table data in blocks of 16 values (registers 2600 - 6680). This corresponds to max. 4096 values. For a working range of 0-125%. Since only 0-100% (3277 values) can efficiently be used, it suffices to load data for 0-100%.

3. Submit table data (register 858).
4. Set static values which are not affected by the table UI function: current (register 501 or CURR command) and power (register 502 or POW command) IU function: voltage (register 500 or VOLT command) and power (register 502 or POW command) Step 5:
5. Run the function generator with start/stop (register 850) resp., if still not done, switch on the DC input/output of your unit (register 405). For PV mode and function, you may also want to control irradiation while the function is running. This is done by sending set values to register 501 (current), where 100% corresponds to a factor of 1 and 0% to a factor of 0. This factor is multiplied to the simulated current value IMPP, which you have to enter in the HMI as a parameter of the simulated solar panel or which is defined by the loaded table.
6. Exit the function generator by deselecting your former selection of either UI (register 854), IU (register 855) or PV (register 426) again.

7.11.8 Registers 9000 - 9009 (Adjustment limits)

For SCPI use, see 7.12.9.1, “Adjustment Limit Commands” on page 172. ModBus users should also read that section for the general handling of these settings. Apart from that, setting these parameters is like setting a set value (U, I, P, R).

7.11.9 Registers 10007 - 10900

Those registers can be used to remotely configure the various built- in or optionally available digital interfaces for the above stated series. The registers are connected to the corresponding settings in the unit's setup menu, where featured. Contrary to manual control, the settings for the interface modules can be configured while the interface module is not yet installed.

7.11.10 Register from 12000 (PV simulation / DIN EN 50530)

Photovoltaics simulation is a function based on the XY generator.

The advanced simulation according to DIN EN 50530 is supported from firmware KE 2.19 and HMI 2.10. All ModBus registers which represent parameters related to this simulation and can be written to the unit or read from are referenced in the EN 50530 standard document. The document is furthermore the reference for the user regarding setup and correct use of this simulation feature.

The procedure to set up and control the extended PV simulation using ModBus protocol is no different to manual handling on the unit's front panel or when using SCPI commands (see examples in SCPI section 7.12.18.5, “Examples for PV Simulation (DIN EN 50530)” on page 197). These step by step examples have an extra column in the table that holds the related ModBus register number. One of these examples (nr. 2) converted to ModBus RTU format (percent set values translated for a unit with 80 V and 170 A rating):

Configuration (before start)

Nr.	Command	Description
1	00 05 01 92 FF 00 2D FA	Activate remote control
2	00 06 2E E1 00 03 91 04	Activate PV simulation mode DAYET
3	00 06 2E F0 00 00 81 00	Select technology: Manual (all required parameters must be defined, here as with commands 4-10)
4	00 10 2F 02 00 02 04 3F 4C CC CD F7 ED	Fill factor voltage (FF _U): 0,8
5	00 10 2F 04 00 02 04 3F 47 AE 14 EE FF	Fill factor current (FF _I): 0,78
6	00 10 2F 06 00 02 04 39 9D 49 52 84 57	Temperature coefficient α for I _{SC} : 0,0003 /°C
7	00 10 2F 08 00 02 04 BB 44 9B A6 A1 7F	Temperature coefficient β for U _{OC} : -0,003 /°C
8	00 10 2F 0A 00 02 04 3D 94 7A E1 00 75	Scaling factor C _U for U _{OC} : 0,0725
9	00 10 2F 0C 00 02 04 39 66 AF CD 7F D1	Scaling factor C _R for U _{OC} : 0,00022 m ² /W
10	00 10 2F 0E 00 02 04 3B 4E 70 3B A7 CE	Scaling factor C _G for U _{OC} : 0,00315 W/m ²
11	00 05 2E F1 FF 00 D5 30	Select input mode: ULIK
12	00 06 2F 10 61 47 E8 A8	Set open circuit voltage: 38 V (=0x6147)
13	00 06 2F 11 08 6F 97 26	Set short-circuit current: 7 A
14	00 05 2E F2 FF 00 25 30	Activate data recording
15	00 05 2E E5 00 00 D4 C4	Deactivate interpolation of day trend data

Write day trend data (before the start)

Nr.	Command	Description
16	00 05 2E E6 FF 00 65 34	Select access mode: write
17	00 05 2E E7 FF 00 34 F4	Delete former data (should be executed every time before loading new data)
18	00 10 2E EA 00 06 0C 00 00 01 44 44 66 66 00 00 01 F4 88 23	Write 1 st day trend data set: Irradiation: 500 W/m ² Temperature: 20°C Dwell time: 500 ms
19	00 10 2E EA 00 06 0C 00 00 02 6D 3A 74 0D 00 00 05 DC E4 C3	Write 2 nd day trend data set: Irradiation: 800 W/m ² Temperature: 28°C Dwell time: 1500 ms
...		Write further data sets, a total of 500
517	00 10 2E EA 00 06 0C 00 00 01 F4 A3 D6 7F FF 00 00 4E 20 34 AF	Write 500. day trend data set: Irradiation: 1200 W/m ² Temperature: 35°C Dwell time: 20000 ms

Control, also during simulation run

Nr.	Command	Description
518	00 05 2E E6 FF 00 65 34	Start simulation -> the simulation will stop automatically after the time that results from the total of dwell times in all written data sets

Analysis after simulation end

Nr.	Command	Description
519	00 03 2E F4 00 02 8D 00	Read number (n) of recorded data sets. This number is not related to the number of day trend data sets in use. This feature records a new data set every 100 ms. Depending on the total simulation time, the record buffer could fill (max. 16 h record time) and overwrite existing data. It may become necessary to calculate the total simulation time from the day trend data sets and start reading the recorded data during simulation, then clearing the buffer and later read the rest of data.
520	00 10 2E F6 00 02 04 00 00 00 01 6C 5C	Select first data set (index 1) for reading
521	00 03 2E F8 00 08 CD 04	Read data from data set (index) 1
...		Read further n-1 data sets:

7.12 SCPI Command Language

The SCPI standard does not define the use of a termination character and thus, models supporting SCPI do not expect one. Exception to this are units with Opt GPIB interface. See 7.12.2, “SCPI Command Syntax” on page 161 for termination character information.

Note: With other interfaces like Ethernet, messages could be fragmented or merged (TCP) or when sent as single characters via serial ports communication errors can occur, which are put into the error queue and are not returned automatically. In such cases, it is recommended to add a termination character.

Set Value Formats

In the SCPI command language, all commands are text based and values are real values, usually without a unit. This means that if you want to set a current of, for example, 177.5 A, you would use the simple command CURR 177.5. Below you will find more detailed information about the available commands and the syntax.

All set values (U, I, P, R), which have dedicated single command which you can send to the unit during remote control. Values are not only limited by the maximum, i.e. nominal values of your particular unit model, but are limited by those adjustment limits “Limits” that you can define for manual adjustment, i.e. user limit settings.

7.12.1 SCPI Examples

IDN Query

It is always recommended to ping a unit first, in order to test if it responds at all. With SCPI, this is done by querying the identification string:

Protocol	Command
SCPI	*IDN?

As an immediate response, the unit might send, for example:

Protocol	Response
SCPI	Adaptive Power Systems, DCS80-510, 1240210002, V2.14 14.05.2018 V2.24 04.06.2018 V1.6.5

Switching between Remote and Manual Control

Before you can remotely control a unit, you need to switch it to remote control by sending the dedicated command. See the SCPI command description below.

The unit will not switch to remote control automatically and cannot be remotely controlled without being in this condition. Reading status and values is but always possible.

The unit will not exit remote control automatically, unless it is switched off or the AC supply is otherwise interrupted. Remote control can be exited by a certain command. It then switches back to manual control.

Switching to remote control may be inhibited by several circumstances and is usually indicated by an error message:

- Condition “Local” is active (check the display or control panel on the front of your unit), which will prevent any remote control
- The unit is already remotely controlled by another interface
- The unit in setup mode, means the user has accessed the setup menu and not left it yet

Switch a unit to remote control:

If you are using SCPI command language, send a text command (the space is required):

SYST:LOCK_1 or SYST:LOCK_ON

Leaving remote control can be done in two ways: using the dedicated command or by switching the unit to “Local” condition. We will consider the first option, because this is about programming.

Exit remote control:

If you are using SCPI command language, send a text command (the space is required):

SYST:LOCK_0 or SYST:LOCK_OFF

7.12.2 SCPI Command Syntax

The following syntax formats are supported for commands and/or queries:

Format	Description
Values	This numeric value corresponds to the value in the display of the unit and depends on the nominal values of the unit. Rules: - The value must be sent after the command and separated by a space - Instead of a numeric value you can also use:
MIN	corresponds to the minimum value of the parameter
MAX	corresponds to the maximum value of the parameter
<NR1>	Numeric values without decimal place
<NR2>	Numeric values with decimal place
<NR3>	Numeric values with decimal place and exponent
<NRf>	<NR1> or <NR2> or <NR3>
Unit	V (Volt), A (Ampere), W (Watt), OHM, s (Seconds)
<CHAR>	0..255: Decimal value
<+INT>	0..32768: Positive integer value (output from unit)
<B0>	1 or ON: Function is/will be activated 0 or OFF: Function is/will be deactivated
<B1>	NONE: manual operation active, switching to remote control possible LOCAL: local (manual) operation only, reading of data possible REMOTE: unit is in remote control
<ERR>	Error with number (-800 to 399) and description
<SRD>	String data, various formats: - IP address as number string with dots as separator, for example “192.168.0.2” - Key words, for example AUTO or OFF
<Time>	[s].s[s][s][s][s][s] / Default format is seconds (s.s)
;	The semicolon is used separate multiple commands within one message
:	The colon separates the SCPI keywords (main system, subsystems)
[]	Lowercase letters and the content of square brackets are optional

Format	Description
?	The question mark identifies a message as query. A query can be combined with a control message (command concatenation). Note that it is required to wait for the response of the query before the next control message can be sent.
->	Response from unit

Table 7-3: Supported SCPI Command and Parameter formats

Coupled Commands

It is possible to couple, i.e. concatenate up to 5 commands in one message. The commands must then be separated by a semicolon (;). Example:

VOLT 80;CURR 20;POW 3kW

The command in the string are processed from left to right, so the order of commands is important to achieve correct results. When querying multiple values or parameters at once, the returned string is also in coupled format, with the queried returns separated by semicolons.

Note: Returned messages can be up to 512 characters. When querying coupled commands where the response would exceed 512 characters, like when querying 5x *IDN?, nothing is returned.

Long form and short form

SCPI commands have a long and a short form. The short form (e.g. SOUR) and the long form (e.g. SOURCE) can be used arbitrarily. To distinguish both forms, the commands as described in the following sections are written partly in upper case (indicates short form), partly in lower case letters (indicates the optional part of the long form).

Termination Character

Some interfaces like for example GPIB require a termination character at the end of each message. On other interfaces, termination characters are supported, but optional, in order to maintain compatibility between several different interfaces in control software using SCPI. Units with GPIB option installed, a termination character is required or a timeout error will occur.

Supported termination character(s): 0xA (LF, line feed)

7.12.3 SCPI Errors

Errors in terms of SCPI are only communication errors. According to the standard, units using SCPI do not return errors immediately. They have to be queried from the unit. The query can occur directly with the error command (SYST:ERR?) or by first reading the signal bit "err" from the status byte (STB) register (see Status registers).

The error format is defined by the standard and is made of a string containing a number (the actual error code) and an explanatory text. Following errors strings are supported by the unit.

Error code / error text	Description
0, "No error"	No error
-100, "Command error"	Command unknown
-102, "Syntax error"	Command syntax wrong
-108, "Parameter not allowed"	A command was sent with a parameter though the command doesn't use parameters
-200, "Execution error"	Command could not be executed
-201, "Invalid while in local"	Control command could not be executed, because unit is in LOCAL mode
-220, "Parameter error"	Wrong parameter used
-221, "Settings conflict"	Command could not be executed because of the condition of the unit (being in MENU etc.)
-222, "Data out of range"	Parameter could not be set because it exceeded a limit
-223, "Too much data"	Too many parameters per command or too many commands at once
-224, "Illegal parameter value"	A parameter not specified for the command has been sent
-999, "Safety OVP"	Alarm Safety OVP (only available with specific models) has been triggered. It requires the unit to be power cycled.

Table 7-4: SCPI Error Messages

7.12.4 Standard IEEE Commands

The IEEE488.2 GPIB standard requires some standard commands to be supported. They are supported in all instruments that feature SCPI command language.

*CLS

Clears the error queue and the status byte (STB).

*IDN?

Clears the error queue and the status byte (STB).

*IDN?

Returns the unit identification string, which contains following information, separated by commas:

1. Manufacturer
2. Model name
3. Serial number
4. Firmware version(s) (in case there are several, these are separated by a space)
5. User text (arbitrary user-definable text, as definable with SYST:CONFIG:USER:TEXT)

*RST

This command sets the unit to a defined state, except when remote control is denied by the unit:

1. Switch to remote control (same as SYST:LOCK 1)
2. Set DC input/output to off
3. Clear alarm buffer
4. Clear status registers to default condition (QUESTionable Event, OPERation Event, STB)

***STB**

Reads the **STatus Byte** register. The signal run of the various conditions and events is illustrated in the register model below. The STB bits in particular:

- Bit 0: not used
- Bit 1: not used
- Bit 2: err, Error Queue --> one or several error in the error buffer. By reading the error buffer or sending *CLS it is flushed and the bit err is reset
- Bit 3: ques, Questionable Status Register is active (one or several events have occurred) Bit 4: not used
- Bit 5: not used
- Bit 6: not used
- Bit 7: oper, Operation Status Register is active (one or several events have occurred).

7.12.5 Status Register

Not all unit conditions and alarms can be read with dedicated SCPI commands. As an alternative, the remaining unit-related information are grouped in status registers. Using regular polling, the status byte (STB) can be a starting point for reading the unit status. It tells what status register has recorded at least one event. Apart from that, the other status registers could also be polled directly. The difference then would be, that the user would have to find out, what bits in the register have changed, by comparing the most recent value with an older value. The bits in the status byte register will do that job for you. If they remain 0, nothing has happened.

Once a bit in the STB signals that there was an event recorded in QUES or OPER register, you could read the corresponding event register of OPER and QUES, in order to find out which bits have changed in the COND register.

SPCI Status Register model:

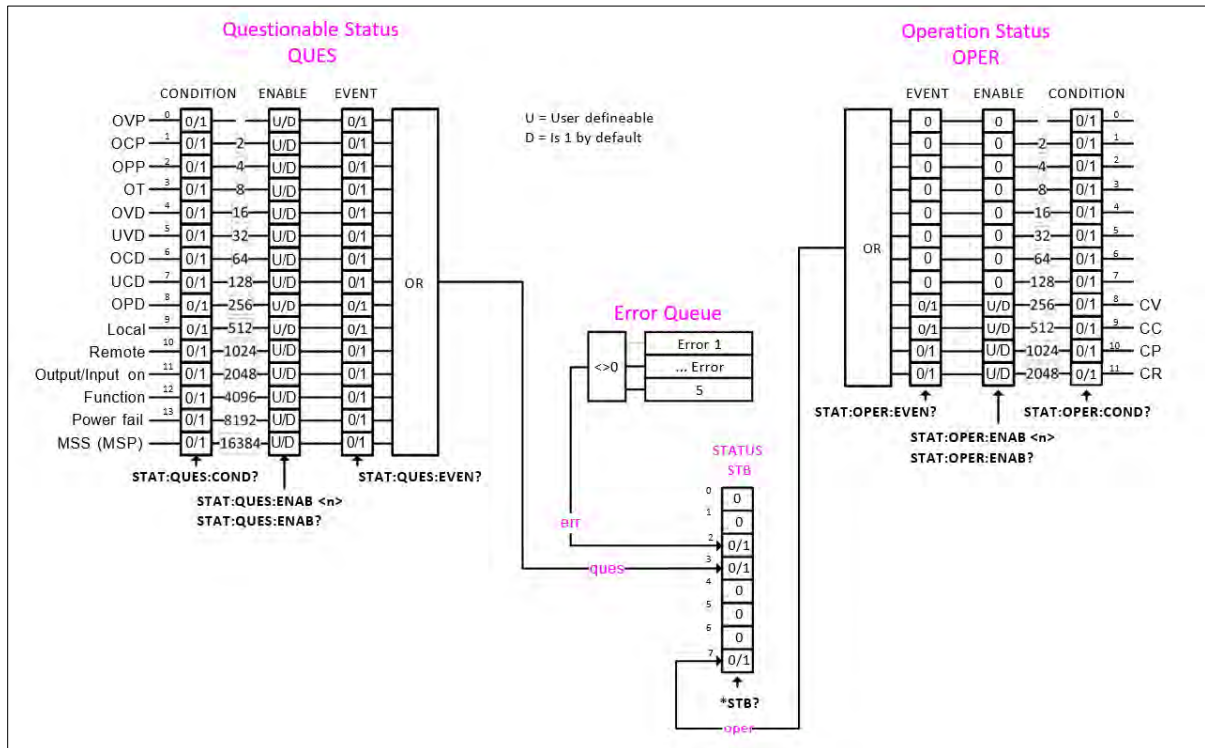

Figure 7-1: SPCI Register Model

Note: Events recorded in the event registers STAT:QUES:EVENT and STAT:OPER:EVENT only record PTRs (positive transition), i.e. the changeover from 0 to 1.

Note: Unit alarms, like OVP, have to be acknowledged. They are signaled via CONDITION and EVENT registers. Reading SPCI errors with SYST:ERR? or SYST:ERR:ALL? is also considered as alarm acknowledgement and will clear the alarm bit in CONDITION, but only if the alarm condition is not present anymore. Acknowledged alarms can later only be read from the unit as an alarm counter (where featured, only available from a certain KE firmware version). It is recommended to regularly poll alarms from the unit and to read STAT:QUES? prior to SYST:ERR?.

7.12.5.1 STATus:QUEStionable?

Reads the Questionable status EVENT or CONDITION register. The unit will return a 16 bit value, which represents unit information as defined in the register model.

- Query form 1: STATus:QUEStionable:CONDition?
- Query form 2: STATus:QUEStionable:EVENT?
- Query form 3: STATus:QUEStionable?

Examples:

- STAT:QUES? --> 3072 Reads the event register. This value tells, that bits 10 and 11 are set and according to the register model this is interpreted as “remote control = active” and “DC input/output = on”.
- STAT:QUES:COND? Reads the condition register of the questionable status register. The value contains the current snapshot of a number of status bits.

7.12.5.2 STATus:QUESTIONable:ENABLE_<NR1>

This command sets or read the Enable register of the Questionable status register. The Enable register is a filter that enables all or single bits to signal an event to the status byte STB. By default, all bits of the Enable register are set. In case you want to ignore certain bits, you just need to add the values of the remaining bits and send the value to the Enable register.

Query form: STATus:QUESTIONable:ENABLE?
Value range: 0...32767

Example:

STAT:QUES:ENAB_3072 Sets the enable register of the questionable status registers to 3072 and enables the bits “OVP”, “OT”, “Remote” and “Input/Output on” for event reporting to STB.

7.12.5.3 STATus:OPERation?

Reads the Operation status EVENT or CONDITION register. The unit will return a 16 bit value, which represents unit information as defined in the register model.

Query form 1: STATus:OPERation:CONDition?
Query form 2: STATus:OPERation:EVENT?
Query form 2: STATus:OPERation?

Examples:

- STAT:OPER? --> 256 Reads the operation register (identical to :EVENT?). A possible response would be a value of 256, which tells, that bit 8 is set and according to the register model bit 8 signals, that “CV” (constant voltage regulation) is active.
- STAT:OPER:COND? Reads the condition register of the operation status registers.

7.12.5.4 STATus:OPERation:ENABLE_<NR1>

Sets or reads the Enable register of the Questionable status register. The Enable register is a filter. It enables single or all bit of the condition registers to change the corresponding bit in the event register. This also impacts the summary bit in the status byte STB. By default, all bits of the Enable register are set to 1. If you want to use only some specific bits to be left through, just add their bit values (see register model) and send the total to the Enable register.

Query form: STATus:OPERation:ENABLE?
Value range: 0, 256...3840

Example:

STAT:OPER:ENAB_1792 Sets the Enable register of the Operation register to value 1792 and enables bits "CV", "CC" and "CP" for reporting events to the STB.

7.12.6 Set Value Commands

7.12.6.1 [SOURce:]VOLTage_<NRf>[Unit]

Sets the output voltage limit of the unit within a certain range, which is either defined by adjustment limits ("Limits", where featured) or is 0...102% nominal value, or reads the last setting. Alternatively, parameters MIN or MAX can be used to instantly set the voltage to the adjustable MINimum or MAXimum.

Query form: [SOURce:]VOLTage?
Value range: <NRf> = 0...1.02 * nominal voltage (according to technical specs)

Examples:

VOLT 12 Absolute short form. Sets 12 V.
SOUR:VOLTAGE_24.5V Mixed form short/long, with unit. Sets 24.5 V, unless the voltage adjustment range has been limited otherwise.
SOURCE:VOLTAGE_MIN Sets the voltage to the defined minimum, usually 0 V.

7.12.6.2 [SOURce:]CURRent_<NRf>[Unit]

Sets the input resp. output current limit of the unit within a certain range, which is either defined by adjustment limits ("Limits", where featured) or is 0...102% nominal value, or reads the last setting. Alternatively, parameters MIN or MAX can be used to instantly set the current to the adjustable MINimum or MAXimum.

Query form: [SOURce:]CURRent?
Value range: <NRf> = 0...1.02 * nominal current (according to technical specs)

Example:

CURR_170 Absolute short form. Sets 170 A.
SOUR:CURRENT_45.3A Mixed form short/long, with unit. Sets 45.3 A, unless the adjustment range of the current has been limited otherwise.
SOURCE:CURRENT_MAX Sets the current to the defined maximum, which is either 102% of the rated current of the unit or, if existing for the particular unit, to the value of adjustment limit "I-max" (also see 5.4.8).

7.12.6.3 [SOURCE:]POWER_<NRf>[Unit]

Sets the input resp. output power limit of the unit within a certain range, which is either defined by adjustment limits ("Limits", where featured) or is 0...102% nominal value, or reads the last setting. Alternatively, parameters MIN or MAX can be used to instantly set the power to zero (MINimum) or MAXimum.

Query form: [SOURCE:]POWER?
Value range: <NRf> = 0...1.02 * nominal power (according to technical specs)

Examples:

POW_3000	Absolute short form. Sets 3000 W, unless the power adjustment range has been limited otherwise.
SOUR:POWER_3.5kW	Mixed form short/long, with unit and magnitude Kilo. Sets 3.5 kW resp. 3500 W, unless the adjustment range of the power has been limited otherwise.
SOURCE:POWER_MIN	Sets the power to the defined minimum, which is usually 0 W.

7.12.6.4 [SOURCE:]RESistance_<NRf>[Unit]

Sets the output power limit of the unit within a certain range, which is either defined by adjustment limits ("Limits", where featured) or is 0...102% nominal value, or reads the last setting. Alternatively, parameters MIN or MAX can be used to instantly set the power to zero (MINimum) or MAXimum.

Query form: [SOURCE:]POWER?
Value range: <NRf> = 0...1.02 * nominal power (according to technical specs)

Examples:

POW_3000	Absolute short form. Sets 3000 W, unless the power adjustment range has been limited otherwise.
SOUR:POWER_3.5kW	Mixed form short/long, with unit and magnitude Kilo. Sets 3.5 kW resp. 3500 W, unless the adjustment range of the power has been limited otherwise.
SOURCE:POWER_MIN	Sets the power to the defined minimum, which is usually 0 W.

7.12.6.5 [SOURCE:]RESistance_<NRf>[Unit]

Power supplies with internal resistance feature use this value to simulate an internal resistor in series to the output, where the output voltage differs from the adjusted value by an amount that calculates from the adjusted resistance value and actual output current. The way of setting the resistance value on both unit types is identical. The adjustable range can be limited with an upper adjustment limit. Alternatively, parameters MIN or MAX can be used to instantly set the resistance to the adjustable MINimum or MAXimum.

Query form: [SOURCE:]RESistance?

Value range: <NRf> = Min. resistance...max. resistance, according to technical specs

Examples:

RES?	Absolute short form. Queries the currently set resistance value.
SOUR:RESISTANCE_10	Mixed form short/long. Sets 10 Ω.
SOURCE:RES_MIN	Sets the resistance to the minimum defined for the particular unit model.

7.12.7 Measurement Commands

Actual values, as returned by the measuring commands, are the DC output values as they are present in the moment they are queried. They are not necessarily identical to the corresponding set values. Your unit constantly measures the actual values and returns the last snapshot when queried.

7.12.7.1 MEASure:[SCALar:]VOLTage[:DC]?

Queries the unit to return the last measured DC input resp. output voltage value in Volt.

Example:

MEAS:VOLT?	Absolute short form. Queries the actual voltage. A response, which should be instantly coming from the unit, will return a value between 0% and max. 125% of nominal unit voltage, like for example “43.50 V”. The number of decimal places in the returned value will be identical to the value format in the unit display and varies from model to model.
------------	---

7.12.7.2 MEASure:[SCALar:]CURRent[:DC]?

Queries the unit to return the last measured DC output current value in Ampere.

Example:

MEASURE:CURRENT?	Queries the actual current only. A response, which should be instantly coming from the unit, will return a value between 0% and max. 125% of nominal unit current, for example “100.1 A”. The number of decimal places in the returned value will be identical to the value format in the unit display and varies from model to model.
------------------	--

7.12.7.3 MEASure:[SCALar:]POWER[:DC]?

Queries the unit to return the last calculated DC input resp. output power value in Watts.

Example:

MEAS:POW?	Absolute short form. Queries the consumed (e-load) resp. supplied power (PSU).
-----------	--

A response, which should be instantly coming from the unit, will return a value between 0% and max. 125% of nominal unit power, for example “2534 W”. No matter how the actual power format is in the unit’s display, here it will always be returned in Watts.

7.12.7.4 MEASure:[SCALar:]ARRay?

Queries the unit to return the last measured resp. calculated actual values of voltage, current and power (in that sequence), separated by commas and with unit and eventually magnitude.

Example:

MEAS:ARR?	Absolute short form. A response, which should be instantly coming from the unit, will return three values between 0% and max. 125% of nominal unit values, for example “12.5 V, 33.3 A, 420 W”
-----------	--

7.12.8 Status commands

Status commands are used to alter the status of the unit in terms of activating remote control or switching the DC output, or to query the current status.

7.12.8.1 SYSTem:LOCK_<BO>

This command is used to activate remote control of a unit. The remote control has to be activated first before you can send any command that changes unit status or value. Once remote control has been activated via one of the digital interfaces, only that interface is in charge.

The activation of remote control can be refused by the unit due to several reasons. It usually results in a SCPI error which is put into the SCPI error buffer. This buffer can be read with the error command (SYSTem:ERRor?).

Query form:	SYSTem:LOCK:OWNer?
Value range for set:	ON, OFF
Value range for query:	REMOTE, NONE, LOCAL

Examples:

SYST:LOCK_ON	Absolute short form. Requests the unit to switch to remote control. The unit then usually indicates activated remote control either by a LED or a status text in the display.
SYSTEM:LOCK:OWNER?	Queries the lock owner regarding remote control. This can be used to verify whether the unit has accepted the request to switch to remote control or not. It can return three different statuses: REMOTE = Unit is in remote control via any of the available interfaces NONE = Unit is not in remote control

LOCAL = Unit is in LOCAL condition, which denies or interrupts remote control. Usually actually manually on the unit's front panel

7.12.8.2 OUTPut_<BO>

This command is used to switch the DC Input on or off.

Query form: OUTPut?
Value range: ON, OFF

Examples:

OUTP_1	Absolute short form. Switches the DC Input on if remote control is active.
OUTPUT?	Queries the condition of the DC Input, which will be returned as ON or OFF. Note that the output may be switched off due to a unit alarm.

7.12.8.3 SYSTem:ERRor?

This command is used to read a single error or all errors from the unit's internal SCPI error queue. This queue only contains errors in relation to commands, i.e. wrong syntax, too high values etc. It can not return any unit alarm. Those are usually queried from the unit by reading bits of the status registers (see Status registers). You can chose either to query the next error multiple times until it says "No error" or generally query all at once. After all errors have been read from the buffer, it will be cleared.

The queue is of type FIFO (first in, first out). It means, that the first occurred error is put out first when querying them.

Query form 1	SYSTem:ERRor?	Queries the last or next error
Query form 2:	SYSTem:ERRor:NEXT?	Queries the last or next error
Query form 3:	SYSTem:ERRor:ALL?	Queries all errors in the buffer (up to 5)

Example:

SYST:ERR?	Absolute short form. The unit replies to this query with a string that first contains an error code (see error code list) and second an error description, for example: 0,"No error". This is returned every time no error is present or after all error have been returned.
SYSTEM:ERROR:ALL?	This query will let the unit return up to five concatenated errors in one string, separated by comma plus space.

Note: Querying errors with SYST:ERR? also clears bits related to unit alarms in register QUESTION- able (see Status registers), but only if the alarm condition is "gone". This is considered as acknowledgement by the user. Alarms that have been acknowledged this way can then not be read from the register anymore.

7.12.9 Supervisory Commands

The commands below enable the remote configuration of the supervision features (Events) of the unit, related to voltage, current or power on the DC output.

Command	Description
SYSTem:CONFig:UVD[?]<Nrf>[Unit] SYSTem:CONFig:UVD:ACTion[?]<_>{NONE SIGNAL WARNING ALARM}	Identical to event UVD, as configurable in the unit menu
SYSTem:CONFig:UCD[?]<Nrf>[Unit] SYSTem:CONFig:UCD:ACTion[?]<_>{NONE SIGNAL WARNING ALARM}	Identical to event UCD, as configurable in the unit menu
SYSTem:CONFig:OVD[?]<Nrf>[Unit] SYSTem:CONFig:OVD:ACTion[?]<_>{NONE SIGNAL WARNING ALARM}	Identical to event OVD, as configurable in the unit menu
SYSTem:CONFig:OCD[?]<Nrf>[Unit] SYSTem:CONFig:OCD:ACTion[?]<_>{NONE SIGNAL WARNING ALARM}	Identical to event OCD as configurable in the unit menu
SYSTem:CONFig:OPD[?]<Nrf>[Unit] SYSTem:CONFig:OPD:ACTion[?]<_>{NONE SIGNAL WARNING ALARM}	Identical to event OPD, as configurable in the unit menu

The :ACTion can have following parameters:

- NONE = Event inactive, no supervision
- SIGNAL = As soon as the event occurs, a status text is presented in the status field of the unit's display resp. a bit in the Questionable Register (STAT:QUES?) is set (see Status registers). The bit indicates that a specific event has occurred. This can be used to record the event.
- WARNING = As soon as the event occurs, a warning pop-up is presented in the unit's display resp. a bit in the Questionable Register (STAT:QUES?) is set (see Status registers). The bit indicates that a specific event has occurred. This can be used to record the event.
- ALARM = As soon as the event occurs, a warning pop-up is presented in the unit's display, as well as an acoustic alarm is initiated and the DC input/output is switched off resp. a bit in the Questionable Register (STAT:QUES?) is set (see Status registers). The bit indicates that a specific event has occurred. This can be used to record the event.

Note: The action ALARM lets the unit act similar to when a unit alarms occur. However, unit alarms still have priority. This means that if, for example, the values OVP and OVD would be equal and the output voltage reaches that level, the unit would initiate an OV alarm rather than an OVD event.

7.12.9.1 Adjustment Limit Commands

Adjustment limits are additional, globally effective, adjustable limits for the set values U, I, P and R (where featured). The purpose is to narrow the standard 0...100% adjustment range and to prevent, for example, to accidentally set a too high voltage for the load. There is also the overvoltage protection (OVP), but it is generally better to block irregular set values in the first place.

In case a set value is sent to the unit that would exceed an adjustment limit, no matter if too high or too low, the unit will ignore it and put an error into the error queue. At the same

time it is impossible to set the lower adjustment limit (:LOW) higher than the related set value or, vice versa, the upper adjustment limit.

These commands are related to the "Limits" setting as you can adjust them in the setup menu of the unit.

Command	Description
[SOURce:]VOLTage:LIMit:LOW[?]<NRf>[Unit]	Identical to value U-min, as configurable at the unit
[SOURce:]VOLTage:LIMit:HIGH[?]<NRf>[Unit]	Identical to value U-max, as configurable at the unit
[SOURce:]CURRent:LIMit:LOW[?]<NRf>[Unit]	Identical to value I-min, as configurable at the unit
[SOURce:]CURRent:LIMit:HIGH[?]<NRf>[Unit]	Identical to value I-max, as configurable at the unit
[SOURce:]POWer:LIMit:HIGH[?]<NRf>[Unit]	Identical to value P-max, as configurable at the unit
[SOURce:]RESistance:LIMit:HIGH[?]<NRf>[Unit]	Identical to value R-max, as configurable at the unit

7.12.10 Master/Slave Operation Commands

These commands are used to remotely configure and control the master-slave mode (short: MS). The commands are related to settings in the unit's setup menu.

Configuration and control require a certain procedure. In general:

- Configuration should always be first, but can also be done on the unit's front panel, so that after activating remote control, the master-slave operation can start.

The commands in the tables below are listed in the sequence they should be used (top to bottom).

7.12.10.1 MS Configuration commands

The configuration of MS can be skipped if already done manually at the unit's front panel or was used before in remote control and nothing has changed.

Command	Description
SYSTem:MS:ENABLe_{ON OFF}	Enables (ON) or disables (OFF) master-slave (MS) mode
SYSTem:MS:ENABLe?	Queries, whether the MS is enabled or not
SYSTem:MS:LINK_{MASTER SLAVE} SYSTem:MS:LINK?	Defines or queries the role of the unit in the MS system: MASTER = Unit will be master unit SLAVE = Unit will be slave unit
SYSTem:MS:INITialisation	Starts the MS initialization with the given settings. After a successful initialization, the MS mode can be controlled with further commands. To test if the init has been successful, the next command can be used:
SYSTem:MS:CONDition?	Queries the result of a former MS init. Possible return values: INIT = Init was successful NO INIT = Init was not successful An init is also successful if there is only a master. In order to find out whether you have a complete MS system available or not, you would have to query the number of initialized units from the master with command SYST:MS:UNITS? (see below). Any value other than 0 means, the MS system is initialized and available for control.
SYSTem:MS:UNITS?	Queries the number of units that have been initialized successfully. The number can differ from the expected value, if the master did not initialize one or multiple slaves due to any reason (no connection,

Command	Description
	wrong parameters, double addresses etc.). If only the master has initialized itself, the command will return a 1.
SYSTem:SHARe:LINK_{SLAVE} SYSTem:SHARe:LINK?	This command is only used with electronic loads in two-quadrants operation where they are supposed to be slaves on the Share bus, even if one load unit is master of a master-slave system of loads This only works if <ul style="list-style-type: none"> • The unit is already set to MASTER for master-slave and • Master-slave mode is activated and • The unit is an electronic load, else the unit will generate a "Settings conflict" error.

7.12.10.2 Other MS Commands

Command	Description
SYSTem:MS:NOMinal:VOLTage?	Queries the total voltage of the initialized MS system. The voltage of a MS system will increase in a series connection, compared to a single unit. Series connection is only allowed for power supplies
SYSTem:MS:NOMinal:CURREnt?	Queries the total current of the initialized MS system. The current of a MS system will increase on a parallel connection, compared to a single unit
SYSTem:MS:NOMinal:POWer?	Queries the total power of the initialized MS system. The power of a MS system will always increase, compared to a single unit

Note: The nominal values, as calculated during a MS initialization procedure, are different to the nominal values of a single unit and thus have extra commands. These values are only used for master-slave applications.

7.12.11 Commands for general queries

The following commands can be used to query other information from the unit.

Command	Description
SYSTem:NOMinal:VOLTage?	Queries the nominal, i.e. maximum input/output voltage
SYSTem:NOMinal:CURREnt?	Queries the nominal, i.e. maximum input/output current
SYSTem:NOMinal:POWer?	Queries the nominal, i.e. maximum input/output power
SYSTem:NOMinal:RESistance:MINimum?	Queries the minimum internal resistance value.
SYSTem:NOMinal:RESistance:MAXimum?	Queries the maximum internal resistance value
SYSTem:DEVice:CLAss?	Queries the device class and lets the unit return a value which defines to what model class the unit belongs to. This is an easy way to distinguish different unit types, like an electronic load from a power supply.

7.12.12 Unit Configuration Commands

The commands listed below are used to modify settings of the unit's configuration. The settings can be part of the current user profile. Any modification on the configuration requires activation of remote control. These settings are automatically stored.

Command	Description
SYSTem:CONFig:INPut:REStore[?]{_}{AUTO OFF} SYSTem:CONFig:OUTPut:REStore[?]{_}{AUTO OFF}	Defines the condition of DC input/output after the unit is powered on. This is related to the unit setting "DC input after power on" resp. "DC output after power on". AUTO = DC input/output will be restored to the condition it had when switching the unit off the last time OFF = DC input/output will always be off
SYSTem:CONFig:USER:TEXT_{<SRD>} SYSTem:CONFig:USER:TEXT?	Writes or queries a user-definable text of up to 40 characters permanently to the unit. This string can be used to add custom information to the unit, in order to distinguish it from other, identical models, alternatively to the serial number.
SYSTem:CONFig:ANALog:REFErence_{5 10} SYSTem:CONFig:ANALog:REFErence?	Select the voltage range for analog inputs and outputs of the analog interface. This has no effect on anything concerning digital remote control. 5 = 0...5 V range 10 = 0...10 V range (factory setting)
SYSTem:CONFig:ANALog:REMSB:LEVEl_{NORMAL INVERTED} SYSTem:CONFig:ANALog:REMSB:LEVEl?	Determines how pin REM-SB of the analog interface shall be interpreted by the unit: NORMAL = level and conditions (factory setting) INVERTED = level and conditions are interpreted as inverted
SYSTem:CONFig:ANALog:REMSB:ACTIon_{OFF AUTO} SYSTem:CONFig:ANALog:REMSB:ACTIon?	Determines the action that is caused by using pin REM-SB of the analog interface in connection with DC input/output of the unit: OFF = pin can only be used to switch the DC input/output off AUTO = pin can be used to switch off and on again, if the DC input/output was at least switched on once by pushbutton on the control panel or digital command
SYSTem:CONFig:MODE_{UIP UIR} SYSTem:CONFig:MODE?	Selects the operation mode between U/I/P and U/I/R. Both modes are available. By selecting U/I/R, the adjustable resistance value (command [SOURCE:]RESistance is unlocked. Activated U/I/R mode can only be detected in the display from the resistance value being shown.
SYSTem:COMMunicate:PROTOcol:MODBus_{ENABLE DISABLE} SYSTem:COMMunicate:PROTOcol:MODBus?	Enables or disables ModBus protocol on the unit. This setting is stored. After disabling ModBus with this command, further ModBus messages are ignored, so that only SCPI commands are accepted. Only one of both protocols can be deactivated at the same time.
SYSTem:COMMunicate:TIMEout_{5...65535} SYSTem:COMMunicate:TIMEout?	Defines a timeout in milliseconds (factory setting: 5 ms), a max. time that can elapse between two consecutive bytes, before the unit considers the message as "completely received". Note: this only applies for serial interfaces (USB, RS232)
POWer:STAGe:AFTer:REMOte_{ AUTO OFF } POWer:STAGe:AFTer:REMOte?	Defines, how the DC input/output of the unit shall be after leaving remote control. AUTO = Last condition remains OFF = DC input/output will be switched off

Command	Description
SYSTem:ALARm:ACTion:PFAil_{ AUTO OFF } SYSTem:ALARm:ACTion:PFAil?	Defines, how the DC input/output of the unit shall be after a power fail (PF) alarm, which could be a mains blackout or similar and after which the unit could continue its work automatically. AUTO = DC input/output condition before PF is restored OFF = DC input/output will be switched off

7.12.13 Interface Module Commands (Excl. Ethernet)

Most of the optional interface modules can also be remotely configured using SCPI commands, either via USB port or even via the interface itself. These settings are saved automatically.

Command	Description
SYSTem:COMMunicate:INTerface:CODE? SYSTem:COMMunicate:INTerface:CODE?	Returns a value, representing a model code for the installed Anybus interface module: 5 = Profibus 21 = Ethernet 2P 9 = RS232 22 = ModBus TCP 2P 16 = CANopen 23 = Profinet/IO 2P 18 = ModBus TCP 1P 25 = CAN 19 = Profinet/IO 1P 26 = EtherCAT 20 = Ethernet 1P
SYSTem:COMMunicate:INTerface:TYPE?	Queries the name of the installed interface module.
SYSTem:COMMunicate:INTerface:SERial?	Queries the serial number of the installed interface module.
SYSTem:COMMunicate:INTerface:ADDRess_{NR1}> SYSTem:COMMunicate:INTerface:ADDRess?	Sets the Profibus address of the Profibus module IF-AB-PBUS or queries it. Allowed range: 0...125
SYSTem:COMMunicate:PROFibus:ID?	Queries the Profibus ID of the unit manufacturer.
SYSTem:COMMunicate:PROFibus:FTAG_{SRD}> SYSTem:COMMunicate:PROFibus:FTAG?	Sets or queries the Profibus/Profinet specific "function tag", a string of up to 32 characters
SYSTem:COMMunicate:PROFibus:LTAG_{SRD}> SYSTem:COMMunicate:PROFibus:LTAG?	Sets or queries the Profibus/Profinet specific "location tag", a string of up to 22 characters
SYSTem:COMMunicate:PROFibus:DATE_{SRD}> SYSTem:COMMunicate:PROFibus:DATE?	Sets or queries the Profibus/Profinet specific "date tag", a date/time string of up to 40 characters
SYSTem:COMMunicate:PROFibus:DESCRiption_{SRD}> SYSTem:COMMunicate:PROFibus:DESCRiption?	Sets or queries the Profibus/Profinet specific "description" tag, a string of up to 54 characters
SYSTem:COMMunicate:PROFibus:NAME_{SRD}> SYSTem:COMMunicate:PROFibus:NAME?	Sets or queries the Profinet specific "station name", a string of up to 200 characters
SYSTem:COMMunicate:INTerface:BAUD_{NR1}> SYSTem:COMMunicate:INTerface:BAUD?	Queries or sets the bus speed, i.e. baud rate of a CANopen or RS232 interface module. The unit will only save the value. This means, with value 3 being saved and CANopen installed, it will run at 100 kbps and with RS232 installed, with 19200 Baud.
SYSTem:COMMunicate:CAN:BRoadcast_{NR1}> SYSTem:COMMunicate:CAN:BRoadcast?	Sets the CAN broadcast ID for normal CAN communication. Allowed range: 0...2047 (11 bit) resp. 0...536870911 (29 bit)

Command	Description
SYSTem:COMMunicate:CAN:DLC_{AUTO FILL} SYSTem:COMMunicate:CAN:DLC?	CAN data length setting for response messages from the unit. AUTO = the number of data bytes in a CAN message from the unit (response) varies according to the used command/register (default) FILL = the number of data bytes in a CAN message is always 8, filled with zeros
SYSTem:COMMunicate:CAN:FORMat_{BASE EXT} SYSTem:COMMunicate:CAN:FORMat?	Selects the CAN address format. BASE = 11 Bit (CAN 2.0A) (default) EXT = 29 Bit (CAN 2.0B)
SYSTem:COMMunicate:CAN:NODE_{<NR1> SYSTem:COMMunicate:CAN:NODE?	Sets the CAN base ID for normal CAN communication. Allowed range: 0...2047 (11 bit) resp. 0...536870911 (29 bit)
SYSTem:COMMunicate:CAN:READ:NODE_{<NR1> SYSTem:COMMunicate:CAN:READ:NODE?	Sets the CAN base ID for cyclic. Allowed range: 0...2047 (11 bit) resp. 0...536870911 (29 bit)
SYSTem:COMMunicate:CAN:READ:ACTual_{<NR1> SYSTem:COMMunicate:CAN:READ:ACTual?	Defines the interval (in milliseconds) for the cyclic read of the unit's actual values (U, I, P) over CAN interface IF-AB-CAN. Allowed parameter range: 0 or 20...5000 (0 = cyclic read for this object is deactivated)
SYSTem:COMMunicate:CAN:READ:ALIMits_{<NR1> SYSTem:COMMunicate:CAN:READ:ALIMits?	Defines the interval (in milliseconds) for the cyclic read of the unit's adjustment limits for U and I over CAN interface IF-AB-CAN. Allowed parameter range: 0 or 20...5000 (0 = cyclic read for this object is deactivated)
SYSTem:COMMunicate:CAN:READ:BLIMits_{<NR1> SYSTem:COMMunicate:CAN:READ:BLIMits?	Defines the interval (in milliseconds) for the cyclic read of the unit's adjustment limits for P and R over CAN interface IF-AB-CAN. Allowed parameter range: 0 or 20...5000 (0 = cyclic read for this object is deactivated)
SYSTem:COMMunicate:CAN:READ:SETS_{<NR1> SYSTem:COMMunicate:CAN:READ:SETS?	Defines the interval (in milliseconds) for the cyclic read of the unit's set values (U, I, P, R) over CAN interface IF-AB-CAN. Allowed parameter range: 0 or 20...5000 (0 = cyclic read for this object is deactivated)
SYSTem:COMMunicate:CAN:READ:STAT_{<NR1> SYSTem:COMMunicate:CAN:READ:STAT?	Defines the interval (in milliseconds) for the cyclic read of the unit's status over CAN interface IF-AB-CAN. Allowed parameter range: 0 or 20...5000 (0 = cyclic read for this object is deactivated)
SYSTem:COMMunicate:CAN:SEND:NODE_{<NR1> SYSTem:COMMunicate:CAN:SEND:NODE?	Sets the CAN base ID for cyclic send. Allowed range: 0...2047 (11 bit) resp. 0...536870911 (29 bit)
SYSTem:COMMunicate:CAN:TERMination {ON OFF} SYSTem:COMMunicate:CAN:TERMination?	Switches the integrated CAN bus termination resistor ON or OFF

7.12.14 Ethernet Interface Commands

The commands below are related to the Ethernet interface.

Command	Description
SYSTem:COMMunicate:INTerface:CODE?	Returns a value, representing a model code for the installed interface module:

Command	Description
SYSTem:COMMunicate:LAN:DHCP[?]{ON OFF}	Activates (=ON) or deactivates (=OFF) the DHCP functionality of Ethernet capable units. Default is OFF, so the IP, as set with :ADDR command above, is used
SYSTem:COMMunicate:LAN:ADDRess[?]<SRD>	Queries or sets the IP address of the network port. This IP is used by every Ethernet module. When setting the IP, the string has to in the typical IP format like this: 192.168.0.2
SYSTem:COMMunicate:LAN:SMASk[?]<SRD>	Queries or sets the subnet mask of the network port. This subnet mask is used by every Ethernet module. Format is the same as with the IP.
SYSTem:COMMunicate:LAN:GATEway[?] <SRD>	Queries or sets the gateway address of the network port. This gateway mask is used by every Ethernet module. Format is the same as with the IP. This address is often not used and can thus be left at the default IP.
SYSTem:COMMunicate:LAN:MAC?	Queries the MAC of the currently installed Ethernet interface. If no Ethernet interface is installed, an error will be generated
SYSTem:COMMunicate:LAN:CONTRol[?]{0...65535}	Queries or sets the current TCP port, which is used by all Ethernet module. This port is default 5025 and used for ModBus or SCPI communication. The Ethernet interface may also feature further ports, which are not modifiable.
SYSTem:COMMunicate:LAN:HOSTname[?]<SRD>	Queries or set the host name (refer to network terminology for details). This is a simple ASCII string of up to 54 characters.
SYSTem:COMMunicate:LAN:DOMain[?]<SRD>	Queries or sets the domain name (refer to network terminology for details). This is a simple ASCII string of up to 54 characters. The domain can be used to select and access a particular unit in the network without knowing the IP address.
SYSTem:COMMunicate:LAN:DNS1[?]<SRD>	Queries or sets the network addresses of the first (DNS1, any Ethernet port) and second DNS server (DNS2, only with 2-port modules), if required.
SYSTem:COMMunicate:LAN:DNS2[?]<SRD>	
SYSTem:COMMunicate:LAN:1SPEed[?]{AUTO 10HALF 10FULL 100HALF 100FULL}	Only for IF-AB Ethernet modules (ETH, PNET, MBUS) Sets the communication speed of the network port(s) of Ethernet interfaces with one port (P1) or two ports (P1, P2): AUTO = Auto negotiation 10HALF = 10MBit, half duplex 10FULL = 10MBit, full duplex 100HALF = 100MBit, half duplex 100FULL = 100MBit, full duplex
SYSTem:COMMunicate:LAN:2SPEed[?]{AUTO 10HALF 10FULL 100HALF 100FULL}	
SYSTem:COMMunicate:LAN:TIMEout[?]{0 5...65535}	Defines a socket connection timeout for all Ethernet based interfaces. Also see Connection timeout. Setting this to 0 disables the timeout. Default: 5 seconds
SYSTem:COMMunicate:LAN:KEEPalive[?]{ON OFF}	Enables / disables the so-called "TCP keep-alive" for the network connection of the unit. Also see Connection timeout. Default: OFF

7.12.15 Function Generator Commands

Note: Sequence data or table data, which you can write via SCPI commands, is not stored in the unit.

The function generator is a complex part of the whole control options of the unit. It can be remotely configured and controlled by a set of SCPI commands. When operating the function generator on the front panel of the unit, it requires a certain setup procedure before getting to the actual starting point. The single commands cannot enforce that procedure, so it's up to the user to use them in the correct sequence. What to do:

1. You need to configure the function generator. One of the first things is to select the type of function generator you want to use. Further steps depend on your selection. There are two types available: XY and arbitrary. The XY function generator is usually only used for the functions UI and IU, the arbitrary generator is used for the other functions like sine wave, square wave etc.
2. If you are going to use the arbitrary generator, there is another setup part to do where you first select to which DC input/output value the function, voltage (U) or current (I), will be applied to. The power (P) is not available for wave generation. As a third part of the setup, you should set up the number of sequences to use. This does not happen automatically when filling a certain number of sequences with data, which is done later on.
If you are going to use the XY generator, there is another setup part to do where you need to select whether it shall generate an U-I or I-U curve. Depending on that setting, values you will write to the table, are interpreted. Without this selection, the unit will not accept any table value.
3. Now the sequence(s) to use are filled with data. The arbitrary generator can use X out of 99 possible sequences, which are written with three commands each. The number of sequences to use is variable, but at least 1.

The XY generator, on the other hand, should be filled with 4096 values, which are then interpreted as either voltage, for UI function, or current for IU function, depending on the selection in step 2.

After this, the function generator is completely configured and can be started

Note: When submitting curve data, it is loaded into an internal buffer, which takes some time to process before the command is accepted. We recommend waiting at least 2 seconds after submitting the data and before the next command.

7.12.15.1 Function Generator Configuration Commands

Command	Description
[SOURce:]FUNctioN:GENerator:SElect_{VOLTAGE CURRENT UI IU PV NONE} [SOURce:]FUNctioN:GENerator:SElect?	Select the type of function generator: VOLTage = Arbitrary generator for U CURRENT = Arbitrary generator for I UI = XY generator for U-I curve (also FC) IU = XY generator for I-U curve PV = XY generator for PV curve NONE = Exit function generator

Command	Description
[SOURCE:]FUNCTION:GENERATOR:WAVE:START_{1..99} [SOURCE:]FUNCTION:GENERATOR:WAVE:START?	Arbitrary generator only Defines the start, i.e. first sequence (1...99) or queries the last setting. If only one sequence is used, then it must be :START = :END . Sequences going to be used should also be written with data before submitting them.
[SOURCE:]FUNCTION:GENERATOR:WAVE:END_{1..99} [SOURCE:]FUNCTION:GENERATOR:WAVE:END?	Arbitrary generator only Defines the end, i.e. last sequence (1...99) or queries the last setting. If only one sequence is used, then it must be :START = :END .
[SOURCE:]FUNCTION:GENERATOR:WAVE:NUMBER_{0..999} [SOURCE:]FUNCTION:GENERATOR:WAVE:NUMBER?	Arbitrary generator only Defines, how often the sequence block from :START to :END is cycled through, or queries the last setting. 0 = infinite cycles 1...999 = number of cycles

7.12.15.2 Function Generator Load Sequence Commands

Sequence data should only be sent to the unit after it was switched to function generator mode, which also sets the assignment of the arbitrary generator to U or I.

A function can consist of 1 to 99 sequences, so one sequence is either a complete function or just a part of it. When started, the function generator will execute the sequences from start sequence to end sequence, as defined by the user. With every sequence being variable, the resulting function can be quite complex. The sequence data is loaded into the unit with three commands and in a specific order like this:

Command	Description
[SOURCE:]FUNCTION:GENERATOR:WAVE:LEVEL_{1..99} [SOURCE:]FUNCTION:GENERATOR:WAVE:LEVEL?	1. Selects a sequence (similar to HMI access) to write or queries the currently selected sequence number
[SOURCE:]FUNCTION:GENERATOR:WAVE:INDEX_{0..7} [SOURCE:]FUNCTION:GENERATOR:WAVE:INDEX?	2. For the selected sequence, a set of parameters can be configured. This command selects the parameter between 0 and 7 with value INDEX . The next command (:DATA), is then used to write a value. The indexes are explained below. Can also be used to query the current index.
[SOURCE:]FUNCTION:GENERATOR:WAVE:DATA_{NRf}<NRf> [SOURCE:]FUNCTION:GENERATOR:WAVE:DATA?	3. This will write a value, for example a frequency, to the previously selected parameter, as part of the sequence. Can also be used to query the last value.
[SOURCE:]FUNCTION:GENERATOR:WAVE:SUBMIT	4. Submits all data. Without sending this command, the FG can be started, but will run with all values being zero

Note: The AC and DC start and end values have a dependency from each other. Rule of thumb: use of the AC part requires to set DC values first, else the AC values are not accepted by the unit and an error is put into the SCPI error buffer. The DC values (start, end) must not be smaller than the related AC values (start, end).

Note: It can be useful to read back a value that was just written to the unit, in order to verify whether it has been accepted or not. Alternatively, you may read the error queue

When adjusting parameters for the arbitrary function generator manually on the unit’s front panel, they are limited to each so the resulting signal will work as expected. But in remote control, there will be no feasibility check and so it is up to the user to write correct values.

For example, index 0 is connected to index 5, as the DC value is the base line of the AC amplitude. It means, if you, for instance, want to achieve a sine wave with 5 A amplitude on the DC input current of an electronic load, the base line of the resulting sine wave has to be at minimum 5 A, else the negative wave will be clipped at 0. Indexes 5 and 6 are adjustable DC offsets, which move the AC wave’s base line on the Y axis. So the values in indexes 5 and 6 should at least be as high as index 0 or 1 (whichever is bigger), but they can also be higher. See figures below.

In relation to the adjustments for a function as they can be done on the unit’s front panel, following indexes are selectable and readable/writable with sub command **:DATA**.

Index	Parameter	Value range	Note
0	Start value(AC part) in A or V	0...Nominal value of U or I	For AC part only
1	End value (AC part) in A or V	0...Nominal value of U or I	For AC part only
2	Start frequency in Hz (integer)	0...1000	For AC part only
3	End frequency in Hz (integer)	0...1000	For AC part only
4	Start angle in ° (integer)	0...359	For AC part only
5	Start level (offset) in A or V	0...Nominal value of U or I	For AC and DC part
6	End level (offset) in A or V	0...Nominal value of U or I	For AC and DC part
7	Sequence time in seconds	0.0001...36000	

Note: In case start and end value (indexes 0+1 and indexes 5+6) are not equal, the unit expects a certain minimum change of $\pm 0.058\%/s$ resp. of $\pm 9.3\text{ Hz/s}$ for the start and end frequency (indexes 2+3) over the sequence time. It is therefore not possible to let the input current rise by 1 A over 1 h (ramp), because this exceeds the internal set value resolution by far. Another example: with the sequence time being set to 2 s, a start frequency of 1 Hz and end frequency of 10 Hz would not be accepted, because difference only 9 Hz/s, but start frequency of 30 Hz and end frequency of 5 Hz would.

7.12.15.3 Load table data (XY generator)

The XY generator is based on a table with 4096 values for 0...125% of the referenced physical value. It is expected to write the full table.

It is important to decide whether the table is going to be used for a UI or for a IU function, because the unit will interpret those 4096 values either as voltage or current values. For example, the table might contain values up to 170A for a DCS80-170 with 80 V/170 A, which would be acceptable for a IU function, but not for UI function, because then the table would be interpreted as voltage values where 80 V is maximum and will lead to incorrect results.

Command	Description
[SOURCE:]FUNCTION:GENERATOR:XY:LEVEL_{0...4095}	1. Select one out of 4096 table entries for writing or returns the currently selected entry number.

[SOURce:]FUNCTION:GENerator:XY:DATA_<NRF> [SOURce:]FUNCTION:GENerator:XY:DATA?	2. Writes a value, for example a voltage value, to the previously with :LEVel selected table entry or returns the value.
[SOURce:]FUNCTION:GENerator:XY:SUBmit	3. Submit the data, which has been written so far. Can be any number out of the max. 4096 entries. The rest would then be 0. After this the function can be started

7.12.15.4 Control of the XY Function Generator

After the configuration of the XY generator and after all necessary table data has been loaded, it can be started by simply switching the DC output of the unit on. This is the actual function run and will only stop due to unit alarms or an abort by the user.

7.12.15.5 Control of the Arbitrary Function Generator

In contrast to the XY generator where the curve is immediately active when switching on the DC output, the arbitrary generator requires run control by command. The run cannot be paused. This means, once the function is stopped, no matter for what reason, the next start will run from the beginning, the first sequence in use.

Command	Description
[SOURce:]FUNCTION:GENerator:WAVE:STATE_{RUN STOP} [SOURce:]FUNCTION:GENerator:WAVE:STATE?	Starts/stops the arbitrary function generator or queries the STATE

7.12.15.6 Special function: PV (Photo Voltaics)

The photovoltaics function (PV), as available in the function generator of the DCS Series uses the standard XY generator to calculate a complete table of 4096 values for the XY function generator from a set of only four values (open circuit voltage U_{oc} , short-circuit current I_{sc} , voltage and current of the maximum power point U_{mpp}/I_{mpp}). During function execution, the irradiation value, which simulates different light conditions, can be adjusted.

Command	Description
[SOURce:]IRRadiation_<NR1> [SOURce:]IRRadiation?	Adjust or queries the irradiation value during the solar panel simulation in a range of {0...100} per cent, which affects the DC current and shifts the MPP on the Y axis

With SCPI or ModBus remote control, the PV function is partially supported. Following restrictions apply:

- There are no commands to generate the resulting curve from the four parameters
- There are no commands to enter those four parameters remotely

You have two options to calculate the XY table for use in remote control:

1. You do it externally and then load all data into the unit.
2. You use the HMI, enter the four parameters, let it calculate the table and transfer the data to the internal regulation circuit, then leave function generator mode again and start remote control. With this option, you could also read the entire table from the unit by commands and store it in a file for later use or directly store the function into a file from the HMI using the USB port.

Given that you already switched the unit to remote control and that the XY table for the PV function is already calculated and the data is available, following procedure can be used:

How to setup the unit for PV function:

No.	Command	Description
1	FUNC:GEN:SEL_PV	Select the PV function for the XY generator. By sending this command the unit will switch to function generator mode
2	FUNC:GEN:XY:LEVEL_0	Write all XY table, ie. PV function data to the unit
3	FUNC:GEN:XY:DATA_150	
...		
8192	FUNC:GEN:XY:LEVEL_4095	
8193	FUNC:GEN:XY:DATA_0	
8194	FUNC:GEN:XY:SUB	Submit all data

After submitting all data, it is necessary to wait some time (~1 s) before starting to run the function. Optionally, if not already done, set additional global limits like voltage and power, either to maximum or any other value that does not interfere the PV function run:

No.	Command	Description
8195	VOLT_MAX	Set voltage to max, independent from the model
8196	POW_MAX	Set power to max, independent from the model

After all is set, you can run the function and control the simulation and irradiation. The irradiation then acts as a factor that is multiplied to the current value that is read from the table, so changing this value moves the power point vertically on the Y-axis.

How to control the unit during the PV function run:

No.	Command	Description
8197	OUTP_ON	Switch the DC output of your unit on to make the function start
8198	IRR_85	Set irradiation to 85% (example) or any other value between 0 and 100
8199	OUTP_OFF	Switch the DC output of your device off to make the function stop
8200	FUNC:GEN:SEL_NONE	Parameter NONE selects no function generator type and leaves the function generator mode

7.12.15.7 Special function: FC (fuel cell)

The fuel cell function (FC), as available with the function generator of the DCS series uses the standard XY generator to calculate a complete table of 4096 values for the XY function generator from a set of four supporting points (P1-P4) on a fuel cell simulation curve. During function run, nothing related to the FC simulation can be adjusted. With SCPI or ModBus remote control, the FC function is only supported by using the general XY generator.

Following restrictions apply:

- There are no commands to generate the resulting curve from the four points
- There are no commands to enter those four parameters remotely

The user has two options to calculate the XY table for use in remote control:

1. You do it externally and then load all data into the unit. The procedure to set up the XY generator can be used.
2. You use the front panel, enter the four points, let the unit calculate the table and transfer the data to the internal regulation circuit, then leave function generator mode again and start remote control. With this option, you could also read the entire table from the unit by command and store it in a file for later use or directly store the function into a file from the front panel using the USB port.

7.12.16 Alarm Management Commands

In remote control operation, it is important to manage alarms correctly. This can be done the same way as in manual control. When using SCPI command language, unit alarms are indicated via the status register, which can be polled. Furthermore, most alarms have to be acknowledged.

7.12.16.1 Reading unit alarms

Reading unit alarms should happen in certain intervals, by querying the Questionable status register by either the sub register CONDITION or EVENT. The commands STAT:QUES:COND? or STAT:QUES? resp. STAT:QUES:EVEN? return a value that represents certain bits (see Status registers), indicating various statuses. When a bit is set, it means a certain alarm is present.

7.12.16.2 Acknowledging unit alarms

In order to make the user take notice of unit alarms, they have to be acknowledged after they occurred and vanished again. This will delete those alarms from the status register and should be only be done after they have been recorded. To delete/acknowledge an alarm, the command SYST:ERR? resp. SYST:ERR:ALL? is used, which also serves to query other errors.

In case one or multiple alarms are still present, they won't be cleared from the register by reading it.

There is one exception in handling, the OT (over temperature) error. This doesn't require extra acknowledgement and thus won't be indicated anymore in CONDITION once it is gone.

7.12.16.3 Alarm counters

These counters count alarm occurrences since the last time the unit was powered. They can be read by commands at any time, are not stored when the unit is switched off and are purged by reading.

Command	Description
SYSTem:ALARm:COUNT:OVOLTage?	Counts over voltage alarms (OVP, adjustable threshold)

SYSTem:ALARm:COUNT:OTEMperature?	Counts over temperature alarms (OT, not adjustable)
SYSTem:ALARm:COUNT:OPOWer?	Counts over power alarms (OPP, adjustable threshold)
SYSTem:ALARm:COUNT:OCURrent?	Counts over current alarms (OCP, adjustable threshold)
SYSTem:ALARm:COUNT:PFAil?	Counts power fail alarms (PF, not adjustable)

Example: You are running the unit in remote control and poll the alarm status with the STAT:QUES:COND? command at a certain interval and you always receive value 3072. This is the sum of the bit values of bits 10 (remote) and 11 (output/input on). It tells you that remote control is active and the DC output is switched on. Then a unit alarm occurs caused by the unit overheating. When reading the questionable register the next time, bit 3 should indicate the OT alarm for you to take notice. Additionally, the DC output might be indicated as switched off. Thus the returned value could be 1032 or 3080. Both contain bit's 3 value of 8.

7.12.17 Commands for Extended PV Simulation

All PV simulation related parameters, as settable with the below listed commands, are specified and described in the standard. Thus the standard is also a reference.

7.12.17.1 General configuration

Command	Description
FUNcTion:PHOTovoltaics:MODE_{OFF ET UI DAYET DAYUI} FUNcTion:PHOTovoltaics:MODE?	General mode selection for the PV simulation OFF = simulation mode off (default) ET = Continuous mode, temperature and irradiation can be varied during simulation UI = Continuous mode, voltage and current of the MPP can be varied during simulation DAYET = Day trend mode, no values can be varied, the data set consists of an index, a temperature value, an irradiation value and a dwell time DAYUI = Day trend mode, no values can be varied, the data set consists of an index, MPP voltage and current values and a dwell time
FUNcTion:PHOTovoltaics:IMODE_{MPP ULIK} FUNcTion:PHOTovoltaics:IMODE?	Input mode (applies to all modes selectable with :MODE command, also see matrix and examples in 5.5.3) MPP = The base values to calculate the PV curve from are entered as Umpp and Impp. These values are adjustable simulation mode UI (default) ULIK = The base values to calculate the PV curve from are entered as UOC (open circuit voltage) and IsC (short-circuit current). These values are adjustable in simulation mode ET

7.12.17.2 Day trend mode configuration

The below listed commands can only be used if any of the day trend modes DAYET or DAYUI (see above) has been set before and will else return an error.

Note: It's recommended to clear the old day data with the “:DAY CLEAR” command before loading a new set, especially if the new set is shorter.

Commands	Description
FUNcTion:PHOTovoltaics:DAY:INTErpolate_{ON OFF} FUNcTion:PHOTovoltaics:DAY:INTErpolate?	Only for modes DAYET and DAYUI : ON = Interpolation on OFF = Interpolation off (default)
FUNcTion:PHOTovoltaics:DAY:MODE_{READ WRITE} FUNcTion:PHOTovoltaics:DAY:MODE?	Only for modes DAYET and DAYUI : Day trend mode data access type READ = Read only (default) WRITE = Write only
FUNcTion:PHOTovoltaics:DAY_{CLEAr}	Only for modes DAYET and DAYUI : Clear all data
FUNcTion:PHOTovoltaics:DAY:INDEx_{1-100000} FUNcTion:PHOTovoltaics:DAY:INDEx?	Only for modes DAYET and DAYUI : Select the data index before re-reading day trend data. For writing day trend data, this index values is ignored. Use the index in FUNC:PHOT:DAY:DATA command instead.

Commands	Description
FUNction:PHOTovoltaics:DAY:DATA_{<NR1>, <NRf>, <NRf>, <NR1>} FUNction:PHOTovoltaics:DAY:DATA?	Only for modes DAYET and DAYUI : Write one set of day trend data (4 values) or read them back from it, which requires prior index selection. Depending on the selected day trend mode, different data is returned upon read or must be provided when writing. Mode DAYET: 1. value = index, range: 1- 100000 2. value = irradiation in W/m ² , range: 0-1500 3. value = temperature in °C, range: -40...+80 4. value = Dwell time of index in ms, range: 500...1800000 (^=0,5s...0,5h) Mode DAYUI: 1. value = index, range: 1-100000 2. value = Umpp in V, range: 0...rated voltage 3. value = Impp in A, range: 0...rated current 4. value = Dwell time of index in ms, range: 500...1800000 (^=0,5s...0,5h)
FUNction:PHOTovoltaics:TECHnology_{MAN CSI THIN} FUNction:PHOTovoltaics:TECHnology?	Panel technology preselection. Determines if some simulation parameters are fixed or accessible MAN = Manual mode (all parameters unlocked) CSI = cSi technology panel (default) THIN = thin film technology panel

7.12.17.3 Data recording

The unit can record data while the PV simulation is running in any mode. It records up to 576,000 data sets with 6 values each (actual values of U, I, P and MPP values U, I, P). The recording can be started with the simulation or while it runs. Once the internal memory is filled, it overwrites from the beginning and the number of recorded data sets (:REC:NUM?) is reset to 0. There is one new data set recorded every 100 ms, so that it covers a total time of exactly 16 hours.

The recording is either stopped at the end of the simulation or on purpose by the user. After it is stopped, the recorded data can be read set by set. In case it needs to be saved, read as long as the unit is powered on because the internal memory data is not stored on power off.

Command	Description
FUNction:PHOTovoltaics:RECOrd:ACTive_{ENABLE DISable} FUNction:PHOTovoltaics:RECOrd:ACTive?	Data recording ENABLE = activated DISable = deactivated (default)
FUNction:PHOTovoltaics:RECOrd_{CLEar}	Clear recorded data
FUNction:PHOTovoltaics:RECOrd:NUMBer?	Number of already recorded data sets (1-576000)
FUNction:PHOTovoltaics:RECOrd:INDex_{1-576000} FUNction:PHOTovoltaics:RECOrd:INDex?	Set or read the index number prior to read a data set with :DATA? command

Command	Description
FUNCtion:PHOTovoltaics:RECORD:DATA?	<p>Read data set X from the previously selected index. The unit will then return following values separated by commas, representing a snapshot from a certain time:</p> <ol style="list-style-type: none"> 1. value = Index number 2. value = Actual voltage on the DC output 3. value = Actual current on the DC output 4. value = Actual power on the DC output 5. value = Umpp (voltage in the MPP) 6. value = Impp (current in the MPP) 7. value = Pmpp (power in the MPP)

Note: After selecting the index with FUNC:PHOT:REC:IND, prior to reading the data set, it requires some time (<5 ms) to pass before the unit can return the true data of the index from an internal buffer. Being too early with the request command will cause the unit to write an error into the error queue. After data reception the correct data can be verified by comparing the index number in the data set with the index you selected with FUNC:PHOT:REC:IND.

Note: After start of simulation, the unit will calculate the first PV curve. This takes about 500 ms. But the first data set is already recorded 100 ms after simulation start, so the first 3-4 data set are erroneous. This won't be the case if the recording is started at least 500 ms after the simulation start.

7.12.17.4 Status commands

Status commands and those which read result values from the PV simulation can be used at any time, but it's recommend to carefully chose the moment and order of use.

Command	Description
FUNCtion:PHOTovoltaics:MPP:VOLTage?	Voltage in the MPP, in V. The MPP results from the PV simulation curve, which is calculated by the given simulation settings. The voltage can be between 0 and the rated unit voltage.
FUNCtion:PHOTovoltaics:MPP:CURREnt?	Current in the MPP, in A. Can be between 0 and rated current.
FUNCtion:PHOTovoltaics:MPP:POWer?	Power in the MPP, in A. Can be between 0 and rated power.
FUNCtion:PHOTovoltaics:STATE?	STOP = Simulation has stopped normally, either due to user action or end of day trend
	STOP = Simulation has stopped normally, either due to user action or end of day trend
	RUN = Simulation running
	ERROR MODE = Simulation didn't start due to and error during PC curve calculation in simulation modes ET or UI
	ERROR DAY = Simulation didn't due to and error during PC curve calculation in simulation modes DAYET or DAYUI
	ERRORALARM = Simulation has stopped due to a unit alarm
FUNCtion:PHOTovoltaics:DAY:NUMBer?	ERROR INTERPOLATION = Simulation not started due to a wrong dwell time value in day trend data index 1
	Number of accepted day trend indexes. When transferring day trend data to the unit, this counter counts up every time an index is successfully transferred and accepted. Can ve used to verify written data.

Command	Description
FUNction:PHOTovoltaics:OCVoltage?	Open circuit voltage of the simulated solar panel, calculated with a formula according to the standard. The values is affected by the selected simulation mode, the standard panel parameters (see below) and the calculation factors (also see below).
FUNction:PHOTovoltaics:SCCurrent?	Short-circuit current of the simulated solar panel, calculated with a formula according to the standard. The values is affected by the selected simulation mode, the standard panel parameters (see below) and the calculation factors (also see below).

7.12.17.5 PV Parameter Commands

The commands listed below are used to set or read all the values required for the different PV simulation modes and the PV curve calculation. Not all commands can be written. When trying to write values it is important what simulation mode (ET, UI, DAYET, DAYUI) and what input mode (MPP, ULIK) is currently set. The matrix below indicates which commands are supported in each mode. A third setting, the technology (MAN, CSI, THIN) also determines if a specific parameter is locked from writing, but instead is internally setup with a value according to the DIN EN 50530 standard. Reading the parameters is possible anytime and in every mode.

Command	Writable in modes:				
	MPP	ULIK	MAN	CSI	THIN
FUNction:PHOTovoltaics:FACTOR:FFU_<Nrf> FUNction:PHOTovoltaics:FACTOR:FFU? Fill factor for voltage (FF _U). Only writable in technology selection MAN. Has impact on the PV curve calculation with formula according to standard. Range: >0...1	✓	✓	✓	—	—
FUNction:PHOTovoltaics:FACTOR:FFI_<Nrf> FUNction:PHOTovoltaics:FACTOR:FFI? Fill factor for current (FF _I). Only writable in technology selection MAN. Has impact on the PV curve calculation with formula according to standard. Range: >0...1	✓	✓	✓	—	—
FUNction:PHOTovoltaics:FACTOR:ALPHA_<Nrf> FUNction:PHOTovoltaics:FACTOR:ALPHA? Temperature coefficient α (in 1/°C) for the short-circuit current. Only writable in technology selection MAN. Has impact on the PV curve calculation with formula according to standard. Range: >0...1	✓	✓	✓	—	—
FUNction:PHOTovoltaics:FACTOR:BETA_<Nrf> FUNction:PHOTovoltaics:FACTOR:BETA? Temperature coefficient β (in 1/°C) for the open circuit voltage. Only writable in technology selection MAN. Has impact on the PV curve calculation with formula according to standard. Range: -1...<0	✓	✓	✓	—	—
FUNction:PHOTovoltaics:FACTOR:CU_<Nrf> FUNction:PHOTovoltaics:FACTOR:CU? Scaling factor C _U for the open circuit voltage. Only writable in technology selection MAN. Has impact on the PV curve calculation with formula according to standard. Range: >0...1	✓	✓	✓	—	—

Command	Writable in modes:				
	MPP	ULIK	MAN	CSI	THIN
FUNction:PHOTovoltaics:FACTor:CR_<NRf> FUNction:PHOTovoltaics:FACTor:CR? Scaling factor C_R in m^2/W or the open circuit voltage. Only writable in technology selection MAN. Has impact on the PV curve calculation with formula according to standard. Range: >0...1	✓	✓	✓	—	—
FUNction:PHOTovoltaics:FACTor:CG_<NRf> FUNction:PHOTovoltaics:FACTor:CG? Scaling factor C_G in W/m^2 for the open circuit voltage. Only writable in technology selection MAN. Has impact on the PV curve calculation with formula according to standard. Range: >0...1	✓	✓	✓	—	—
FUNction:PHOTovoltaics:STANdard:OCVoltage_<NRf> FUNction:PHOTovoltaics:STANdard:OCVoltage? U_{OC} (open circuit voltage) of the simulated solar panel in V. Range: 0 - rated voltage	—	✓	✓	✓	✓
FUNction:PHOTovoltaics:STANdard:SCCurrent_<NRf> FUNction:PHOTovoltaics:STANdard:SCCurrent? I_{SC} (short-circuit current) of the simulated solar panel in A. Range: 0 - rated current	—	✓	✓	✓	✓
FUNction:PHOTovoltaics:STANdard:MPP:VOLTage_<NRf> FUNction:PHOTovoltaics:STANdard:MPP:VOLTage? Voltage in the MPP of the simulated solar panel, in V. Range: 0 - rated voltage	✓	—	✓	✓	✓
FUNction:PHOTovoltaics:STANdard:MPP:CURREnt_<NRf> FUNction:PHOTovoltaics:STANdard:MPP:CURREnt? Current in the MPP of the simulated solar panel, in A. Range: 0 - rated current	✓	—	✓	✓	✓

7.12.17.6 PV Control commands

These commands are to control the PV simulation, usually after the successful configuration. In some modes, one or two parameters are adjustable while the simulation is running. Any change of parameter requires calculation of the PV curve again, overwriting the former curve. Depending on what point on the curve the simulation currently is, the point will shift after a certain calculation and response time.

Command	Description
FUNction:PHOTovoltaics:STATE_{RUN STOP} FUNction:PHOTovoltaics:STATE?	Start/stop simulation RUN = Triggers PV curve calculation and succeeding simulation start, if there is no error occurring. If data recording is activated, it will also start STOP = Simulation and possibly running data recording are stopped
FUNction:PHOTovoltaics:TEMPerature_<NR1> FUNction:PHOTovoltaics:TEMPerature?	Only available in mode ET: Solar module temperature in °C. Range: -40...+80
FUNction:PHOTovoltaics:IRRaditation_<NR1> FUNction:PHOTovoltaics:IRRaditation?	Only available in mode ET: Irradiation in W/m^2 . Range: 0-1500

7.12.17.7 PV Error situations

An error situation occurs when the configured simulation cannot be started or it has started already and was running for a while, but then unexpectedly stopped. The command "FUNCTION:PHOTOvoltaics:STATE?" can help in both cases to identify the cause of the error.

Following generally applies:

- Once stopped for any reason, the simulation cannot be continued
- Data from the data recording feature can be read during the simulation or after the stop, as long as the unit remains powered
- All configuration parameters are not stored and are reset when power-cycling the unit

7.12.18 Application Examples

This section provides several examples of using advanced functions using SCPI Commands.

7.12.18.1 Configure and control master-slave with SCPI

Units which feature true master-slave (short: MS) with summing via a dedicated master-slave bus also support full remote configuration and control of the system. In a MS system, usually only the master unit is remotely controlled, while the slaves are not connected to the PC and so cannot be configured remotely. It is thus recommended to configure the MS system on the front panels of the units and only put the master into remote control via any software. Even if you would configure all units manually on the control panel, the remote control software could later read the status of the MS unit from the master. The initialization of the MS system is done automatically every time the master is powered, but can be triggered and repeated by command.

Let's assume the following example configuration: five power supplies DCS80-510 (80 V, 510 A, 15 kW) in parallel. The master has to display itself as an 80V, 2550 A and 75 kW unit after successful configuration and initialization.

These values are also the nominal values of the MS system, used to limit the values you can send by SCPI command. The same way as with manual control, the "Limits" and set values can be adjusted in 0...102% of nominal, while protection values allow for 0..110%.

The step-by-step guide below is separated into several parts, because some are optional.

Part 1a: Configure the master

1. Activate remote control: SYST:LOCK_ON
2. Activate master-slave mode: SYST:MS:ENABLE_ON
3. Define the unit as master: SYST:MS:LINK_MASTER
4. (when running two-quadrants operation and the master in an electronic load): Set the master as Share bus slave: SYST:SHAR:LINK_SLAVE

Part 1b: Configure the slave, in case it is connected to the controlling unit (PC, PLC etc.)

5. Activate remote control: SYST:LOCK_ON
6. Activate master-slave mode: SYST:MS:ENABLE_ON
7. Define the unit as slave: SYST:MS:LINK_SLAVE

If there is more than one slave, repeat steps 4-7 for the other slave(s) with their own addresses.

Part 2: Initialize the MS system

8. Activate remote control, in steps 1-7 were not processed, because system was already configure: SYST:LOCK_ON
9. Trigger initialization, then wait a few seconds: SYST:MS:INIT

Part 3: Further, optional steps

10. Query the initialization status from the master, in order to analyze it: SYST:MS:COND?
11. Query the number of units initialized for the MS system (should be 5 with this example): SYST:MS:UNIT?
12. Query the nominal current of the MS system: SYST:NOM:CURR?
13. Query the nominal power of the MS system: SYST:NOM:POW?
14. Query the maximum resistance of the MS system: SYST:NOM:RES:MAX?
15. Query the minimum resistance of the MS system: SYST:NOM:RES:MIN?
16. Configure protection values, for example OCP: CURR:PROT_400
17. Configure events, for example:
 - set OCD to 2100 A: SYST:CONF:OCD_2100
 - then define the alarm type for OCD to "warning": SYST:CONF:OCD:ACT_WARNING

The adjustment limits ("Limits") require extra treatment, because they are tied to the set values. Means, with the set values being reset to defaults during the MS init, for example the set value of current would be at maximum and thus the related adjustment limit IMax cannot be set lower than this without prior changing the set value.

18. Narrow the adjustable range of values, for example limit the max. current set value to 2200 A
 - First, set the current value down to anything lower than the desired limit, like the minimum: CURR_MIN
 - Second, set the adjustment limit to the value translated for the master unit: CURR:LIM:HIGH_2200

With these settings applied, the current should be at 0, because the lower adjust limit has not yet been changed. The current will be monitored for the threshold of 2100 A by the event system and since it is adjustable up to 2200A, the true current might exceed the threshold and cause an OCD event, which would only generate a warning on screen, but not switch off the DC output.

19. To start working with your MS system, switch the DC output on: OUTP_ON

The system will remain configured and keep the settings when power-cycling it. The master unit has to initialize the MS and the slaves at least one time after power-up. The status of the first automatic initialization can be read from the master by custom software and depending on the result, the software could trigger further steps like the ones above, probably from at least step 8 or if required even from step 1.

7.12.18.2 General Command Sequence for the Arbitrary Generator

Let's say you want to apply a sine wave with 30 A amplitude and 10 Hz frequency for 60 s to the DC input current of an electronic load. This can be achieved by setting up just one sequence. Let's use sequence number 12. Because this is about DC current, the amplitude also requires an offset. The amplitude is usually understood as the difference between the base line, which is here defined by Start(DC) and End(DC) values, and the top value of the sine wave. In this example, the offset then has to be at least 30 A, so let's say 50 A. This will result in a DC input current varying sinusoidal between 20 A and 80 A.

The sine wave, when applied to DC voltage or current, emulates AC characteristics and thus requires to set at least indexes 0, 1, 2, 3, 5, 6 and 7, according to the table above. As long as no specific start angle is required, index 4 can be skipped, because the default value is 0°.

Given that the unit is already in remote control and the DC input resp. DC output is off, following command sequence would be necessary:

No.	Command	Description
1	FUNC:GEN:SEL CURRENT	Selects arbitrary generator for current. By sending this command the unit will switch to function generator mode
2	FUNC:GEN:WAVE:LEVEL_12	Selects the 12th sequence for writing values
3	FUNC:GEN:WAVE:IND_5	Select index 5: Start value of DC part or AC offset
4	FUNC:GEN:WAVE:DATA_50	Set wave offset to 50 A
5	FUNC:GEN:WAVE:IND_6	Select index 6: End value of DC part or AC offset
6	FUNC:GEN:WAVE:DATA_50	Set wave offset to 50 A. If the offset shall not change during the function run, end and start value have to be identical.
7	FUNC:GEN:WAVE:IND_2	Select index 2: Start frequency of sine wave
8	FUNC:GEN:WAVE:DATA_10	Set start frequency to 10 Hz
9	FUNC:GEN:WAVE:IND_3	Select index 3: End frequency of sine wave
10	FUNC:GEN:WAVE:DATA_10	Set end frequency to 10 Hz. If the frequency shall not change during the function run, end and start value have to be identical.
11	FUNC:GEN:WAVE:IND_0	Select index 0: Start value of sine wave amplitude
12	FUNC:GEN:WAVE:DATA_30	Set amplitude to 30 A
13	FUNC:GEN:WAVE:IND_1	Select index 1: End value of sine wave amplitude
14	FUNC:GEN:WAVE:DATA_30	Set amplitude to 30 A. If the amplitude shall not change during the function run, end and start value have to be identical.
15	FUNC:GEN:WAVE:IND_7	Select index 7: Sequence time
16	FUNC:GEN:WAVE:DATA_60	Set sequence point time to 60 s
17	FUNC:GEN:WAVE:END_12	Set end sequence point to 12
18	FUNC:GEN:WAVE:START_12	Set start sequence point to 12

No.	Command	Description
19	FUNC:GEN:WAVE:NUM_1	Set number of sequence point cycles to 1, because that one sequence point will already run for 60 s. Alternatively, it is possible to define 1 s for the sequence point time and let it run through 60 cycles.
20	FUNC:GEN:WAVE:SUBMIT	Load the parameters from above into the function generator

Now you also need to set the three global set values "U/I/P Limits", as you would set them in manual control. This is required, because in function generator mode, the set values of U, I and P from normal operation are not used. In this example with a current sink (i.e. electronic load), it is recommended to set the voltage to 0 V, the power to maximum and the current to 105% or higher of the peak that would result from the sine wave current.

No.	Command	Description
21	VOLT_0	Set voltage to 0 V, so the unit can clearly operate in current control mode
22	CURR_88	The current peak of this example is calculated as 80 A, so we set 110%, means 88 A
23	POW_MAX	Power to max, independent from the model

The function generator is now configured and sequence 12 is set up. You may start to function generator now and control it remotely:

No.	Command	Description
24	INP_ON OUTP_ON	Switch the DC input resp. DC output of your unit on
25	FUNC:GEN:WAVE:STAT_RUN	Start the function with RUN. After 60 s, the function will stop.
26	FUNC:GEN:WAVE:STAT_STOP	Stop/abort function run. The DC input/output will remain on at first and can be switched off with the dedicated command, if necessary
27	FUNC:GEN:SEL_NONE	Parameter NONE will leave function generator mode

7.12.18.3 Command Sequence for the XY Generator

Configuration and loading of table data for XY generator is very similar to the procedure of the arbitrary generator. Let's say you want to make the DC input current of an electronic load react to the input voltage. This is where the XY generator suits well with its IU function.

The IU table with its data determines the current to draw from the source for the entire input voltage range (0...125% U_{Nom}), which is resolved in 4096 values. With this you can define everything you want, like for example the current to remain 0A below a certain input voltage threshold. The desired current curve could be created in Excel or similar tools and exported as CSV file. Because the measurement range for the reference value is defined as 0...125%, but for the depending value it is only 0...100%, the 100% for the depending value is already at table entry $4096/1.25 = 3276$.

There is furthermore a global power limitation, so the unit cannot make 100% voltage at 100% current. When creating the table in Excel or similar, it might help to add another two columns (which are later not exported to CSV, of course). One column, where the referenced value is distributed between 0...125% nominal value over the 4096 entries, and another where the power is calculated for every entry ($P = U * I$), to find out which of the entries could not be physically realized by the unit.

Caution! It is not advisable to have big value differences between two or a group of consecutive table entries. Rather use values that make voltage/current change “softly”.

No.	Command	Description
1	FUNC:GEN:SEL_IU	Select the IU function for the XY generator use: $I = f(U)$. By sending this command the unit will switch to function generator mode
2	FUNC:GEN:XY:LEVEL_0	Select table entry 0 for writing
3	FUNC:GEN:XY:DATA_0	Write a current value to the table entry, here: 0 A (random value)
...		
8192	FUNC:GEN:XY:LEVEL_4095	Select table entry 4095 for writing
8193	FUNC:GEN:XY:DATA_120	Write a current value to the table entry, here: 120 A (example)
8194	FUNC:GEN:XY:SUBMIT	Submit all data

Now it is advised to also define the set values which are not affected by the table, else the function would run without any effect. It means, if you load a UI table, the voltage is set from values in the table, but current and power are static and the values you can adjust for U, I and P in normal operation are not effective here.

For an IU table, voltage and power are static. You can set the static values to any value you like, but in order for the static set values not to interfere in the UI or IU function execution, it is recommended to set both to maximum:

No.	Command	Description
8195	VOLT_MAX resp. CURR_MAX	Set voltage, for an IU function, respectively current, for an UI function, to maximum
8196	POW_MAX	Power to max, independent from the model

After this, the function generator is configured and the IU table is loaded. Now the function can be started by remotely controlling the generator.

No.	Command	Description
8197	INP_ON OUTP_ON	Switch the DC input resp. DC output of your unit on
8198	INP_OFF OUTP_OFF	Switch the DC input resp. DC output of your unit off to make the function stop
8199	FUNC:GEN:SEL_NONE	Parameter NONE selects no function generator type and leaves the function generator mode

7.12.18.4 Command Sequence to Generate a Rising Ramp

Before you can configure the arbitrary generator for a ramp, it is necessary to think about the best way to achieve the ramp generation. It is important to keep in mind that the arbitrary generator stops at the end of the function run, unless you set the repetition to infinite. After a stop, the DC output remains switched on. In case of a ramp, this is wanted, because the end value shall usually remain set for time x. However, the unit will go to static mode again, setting the static set values of U, I and P. The static values also apply for the period before the function run and when the DC output/input is already switched on.

The stop action and the static values are thus a little problematic for the ramp function. Why? Supposed that you wanted to have a power supply generate a ramp starting from 0 V.

The static value for U (voltage) would then be set to zero. But after the function stop, the unit would also set 0 V and the voltage would drop from whatever value has been set during the function run. Conclusion: the static value of voltage has to part of the function.

In order to achieve this, the function has to consist of two parts: one for the rising or falling ramp and the other for the static value. This can be done using two sequence points of the arbitrary generator.

Assumption: the ramp shall start from 0 V and rise to 50 V within 6 seconds. The end voltage shall remain constant for 3 minutes (the time can be varied at will). We are going to use sequence points 1 and 2. Remote control is already active, we only need to configure. Since the ramp will make the voltage rise linearly, using only the DC part of a sequence point, the parameters for the AC part (indexes 0 - 4) should be set to zero, in order to avoid remainders of wrongly set AC parameters to disturb the correct wave generation. The commands need for this are not listed for this example.

Sequence point 1, rising ramp:

No.	Command	Description
1	FUNC:GEN:SEL_VOLTAGE	Selects arbitrary generator for voltage. By sending this command the unit will switch to function generator mode
2	FUNC:GEN:WAVE:LEVEL_1	Select sequence 1 for writing
3	FUNC:GEN:WAVE:IND_5	Select index 5: Start voltage of the ramp
4	FUNC:GEN:WAVE:DATA_0	Set start voltage to 0 V
5	FUNC:GEN:WAVE:IND_6	Select index 6: End voltage of the ramp
6	FUNC:GEN:WAVE:DATA_50	Set end voltage to 50 V
7	FUNC:GEN:WAVE:IND_7	Select index 7: Ramp duration
8	FUNC:GEN:WAVE:DATA_6	Set 6 seconds

Sequence point 2, the static voltage at the ramp end:

No.	Command	Description
9	FUNC:GEN:WAVE:LEVEL_2	Select sequence 2 for writing
10	FUNC:GEN:WAVE:IND_5	Select index 5: Start value of the static voltage (ramp without slope)
11	FUNC:GEN:WAVE:DATA_50	Set start voltage to 50 V
12	FUNC:GEN:WAVE:IND_6	Select index 6: End value of the static voltage (ramp without slope)
13	FUNC:GEN:WAVE:DATA_50	Set end voltage to 50 V
14	FUNC:GEN:WAVE:IND_7	Select index 7: Duration
15	FUNC:GEN:WAVE:DATA_180	Set to 3 minutes (180 seconds)

Configuring the Arbitrary Generator:

No.	Command	Description
16	FUNC:GEN:WAVE:END_2	Set sequence 2 as end sequence
17	FUNC:GEN:WAVE:START_1	Set sequence 1 as start sequence
18	FUNC:GEN:WAVE:NUM_1	Number of cycles
19	FUNC:GEN:WAVE:SUBMIT	Submit all data

The number of cycles is set to 1, so the function runs once and then stops. The value can be changed at will, but with every repetition after 3 m 6 s, the voltage of the ramp would have

to drop from 50 V to 0 V, where the ramp shall start. But it cannot drop in zero time. How long it takes primarily depends on the connected load (supposed you are using a power supply). The resulting ramp could be malformed more or less. In order to avoid that a third sequence could be configured which just gives the voltage some time to drop.

After the ramp function is fully configured and can be started. If the DC output is not yet switched on, it will be automatically switched on when running the function. Alternatively, switching can be done separately with the corresponding commands. Here it is not required, because the function starts from 0 V, but in case a function that does not start at 0, it would be necessary to switch on the DC output first.

No.	Command	Description
20	FUNC:GEN:WAVE:STAT_RUN	Run the function generator

Without repetition the function would stop after one run and after the time defined in sequence point 2 (ignoring the duration of sequence point 1 here, because only 6 s) and the voltage would drop to zero. If you wanted to have the static value remain set for much longer, you would probably need to include the remaining 97 sequence points. With one sequence point, you can achieve a duration of 10 h, so the static value could remain set for a maximum of $99 \times 10 \text{ h} = 990 \text{ h}$.

7.12.18.5 Examples for PV Simulation (DIN EN 50530)

Note: Important: after the simulation start the unit will calculate the first PV curve table. This takes about 500 ms, so the actual simulation begins ~ 500 ms after the start.

Note: It is recommended to always include all setup commands, such as for data recording or interpolation, to have a clean start.

Overview:

	Options: Input mode ULIK	Input mode MPP
Simulation mode		
ET	x	x (example 1)
UI		x (example 3)
DAY ET	x (example 2)	x
DAY UI		x (example 4)

PV Example 1:

- Technology: cSi
- Input mode: MPP values
- Simulation mode: Continuous, with adjustable temperature and irradiation
- Recording: activated

Configuration (before the start):

Nr.	Command	Description	Register
1	SYST:LOCK_ON	Activate remote control	402
2	FUNC:PHOT:MODE_ET	Activate PV simulation mode ET	12001
3	FUNC:PHOT:TECH_CSI	Select technology: cSi	12016
4	FUNC:PHOT:IMOD_MPP	Select input mode: MPP	12017
5	FUNC:PHOT:STAN:MPP:VOLT_20	Set MPP voltage: 20 V	12050
6	FUNC:PHOT:STAN:MPP:CURR_5	Set MPP current: 5 A	12051
7	FUNC:PHOT:REC:ACT_ENABLE	Activate data recording	12018

Control, also during Simulation Run:

Nr.	Command	Description	Register
8	FUNC:PHOT:STAT_RUN	Start simulation	12000
9	FUNC:PHOT:TEMP_40	Adjust temperature value: 40 °C	12052
10	FUNC:PHOT:IRR_800	Adjust irradiation: 800 W/m ²	12053
11	FUNC:PHOT:STAT_STOP	Stop simulation after an arbitrary time	12000

Analysis after Simulation End:

Nr.	Command	Description	Register
12	FUNC:PHOT:REC:NUMB?	Read number (n) of recorded data sets	12020
13	FUNC:PHOT:REC:IND_1	Select first data set (index 1) for reading	12022
14	FUNC:PHOT:REC:DATA?	Read data from data set (index) 1	12024
...	...	Read further n-1 data sets:	...
x	FUNC:PHOT:REC:IND_n	Select data set n (index n) for reading	12022
y	FUNC:PHOT:REC:DATA?	Read data from data set (index) n	12024

PV Example 2:

- Technology: Manual
- Input mode: Open circuit voltage and short-circuit current
- Simulation mode: Day trend with adjustable temperature and irradiation
- Interpolation: deactivated
- Data recording: activated

Configuration (before the start):

Nr.	Command	Description	Register
1	SYST:LOCK_ON	Activate remote control	402
2	FUNC:PHOT:MODE_DAYET	Activate PV simulation mode DAY ET	12001
3	FUNC:PHOT:TECH_MAN	Select technology: Manual (all required parameters must be defined, here as with commands 4-10)	12016
4	FUNC:PHOT:FACT:FFU_0.8	Fill factor voltage (FFU): 0,8	12034
5	FUNC:PHOT:FACT:FFI_0.78	Fill factor current (FFI): 0,78	12036
6	FUNC:PHOT:FACT:ALPH_0.0003	Temperature coefficient α for I_{SC} : 0,0003 /°C	12038
7	FUNC:PHOT:FACT:BETA_-0.003	Temperature coefficient β for U_{OC} : -0,003 /°C	12040
8	FUNC:PHOT:FACT:CU_0.0725	Scaling factor CU for U_{OC} : 0,0725	12042
9	FUNC:PHOT:FACT:CR_0.00022	Scaling factor CR for U_{OC} : 0,00022 m ² /W	12044
10	FUNC:PHOT:FACT:CG_0.00315	Scaling factor CG for U_{OC} : 0,00315 W/m ²	12046

Nr.	Command	Description	Register
11	FUNC:PHOT:IMOD_ULIK	Select input mode: ULIK	12017
12	FUNC:PHOT:STAN:OCV_38	Set open circuit voltage: 38 V	12048
13	FUNC:PHOT:STAN:SCC_7	Set short-circuit current: 7 A	12049
14	FUNC:PHOT:REC:ACT_ENABLE	Activate data recording	12018
15	FUNC:PHOT:DAY:INT_OFF	Deactivate interpolation of day trend data	12005

Write Day Trend Data (before the start):

Nr.	Command	Description	Register
16	FUNC:PHOT:DAY:MODE_WRITE	Select access mode: write	12006
17	FUNC:PHOT:DAY_CLEAR	Delete former data (should be executed every time before loading new data)	12007
18	FUNC:PHOT:DAY:DATA_1,_500,_20,_500	Write 1 st day trend data set: Irradiation: 500 W/m ² Temperature: 20°C Dwell time: 500 ms	12010
19	FUNC:PHOT:DAY:DATA_2,_800,_28,_1500	Write 2 nd day trend data set: Irradiation: 800 W/m ² Temperature: 28°C Dwell time: 1500 ms	12010
...	...	Write further data sets, a total of 500	...
517	FUNC:PHOT:DAY:DATA_500,_1200,_35,_20000	Write 500. day trend data set: Irradiation: 1200 W/m ² Temperature: 35°C Dwell time: 20000 ms	12010

Control during Simulation Run:

Nr.	Command	Description	Register
518	FUNC:PHOT:STAT_RUN	Start simulation -> the simulation will stop automatically after the time that results from the total of dwell times in all written data sets	12000
519	FUNC:PHOT:REC:NUMB?	Read number (n) of recorded data sets. This number is not related to the number of day trend data sets in use. This feature records a new data set every 100 ms. Depending on the total simulation time, the record buffer could fill (max. 16 h record time) and overwrite existing data. It may become necessary to calculate the total simulation time from the day trend data sets and start reading the recorded data during simulation, then clearing the buffer and later read the rest of data.	12020
520	FUNC:PHOT:REC:IND_1	Select first data set (index 1) for reading	12022
521	FUNC:PHOT:REC:DATA?	Read data from data set (index) 1	12024
...	...	Read further n-1 data sets:	...
x	FUNC:PHOT:REC:IND_n	Select data set n (index n) for reading	12022
y	FUNC:PHOT:REC:DATA?	Read data from data set (index) n	12024

PV Example 3:

- Technology: thin film
- Input mode: MPP values
- Simulation mode: Continuous, with adjustable MPP (voltage and current)

- Recording: deactivated

Configuration (before the start):

Nr.	Command	Description	Register
1	SYST:LOCK_ON	Activate remote control	402
2	FUNC:PHOT:MODE_UI	Activate PV simulation mode UI	12001
3	FUNC:PHOT:TECH_THIN	Select technology: Thin film	12016
4	FUNC:PHOT:IMOD_MPP	Select input mode: MPP	12017
5	FUNC:PHOT:STAN:MPP:VOLT_45	Set MPP voltage: 45 V	12050
6	FUNC:PHOT:STAN:MPP:CURR_10	Set MPP current: 10 A	12051
7	FUNC:PHOT:REC:ACT_DISABLE	Deactivate data recording	12018

Control during Simulation Run:

Nr.	Command	Description	Register
8	FUNC:PHOT:STAT_RUN	Start simulation	12000
9	FUNC:PHOT:STAN:MPP:VOLT_40	Shift MPP: 40 V	12050
10	FUNC:PHOT:STAN:MPP:CURR_9	Shift MPP: 9 A	12051
11	FUNC:PHOT:STAT_STOP	Stop simulation after an arbitrary time	12000

PV Example 4:

- Technology: cSi
- Input mode: MPP values
- Simulation mode: Day trend with shift able MPP (voltage and current)
- Interpolation: activated
- Data recording: deactivated

Configuration:

Nr.	Command	Description	Register
1	SYST:LOCK_ON	Activate remote control	402
2	FUNC:PHOT:MODE_DAYUI	Activate PV simulation mode DAY UI	12001
3	FUNC:PHOT:TECH_CSI	Select technology: cSi	12016
4	FUNC:PHOT:IMOD_MPP	Select input mode: MPP	12017
5	FUNC:PHOT:STAN:MPP:VOLT_36	Set open circuit voltage: 36 V	12050
6	FUNC:PHOT:STAN:MPP:CURR_12	Set short-circuit current: 12 A	12051
7	FUNC:PHOT:REC:ACT_DISABLE	Deactivate data recording	12018
8	FUNC:PHOT:DAY:INT_ON	Activate interpolation of day trend data	12005

Load day trend data:

Nr.	Command	Description	Register
9	FUNC:PHOT:DAY:MODE_WRITE	Select access mode: write	12006
10	FUNC:PHOT:DAY_CLEAR	Delete former data (should be executed every time before loading new data)	12007
11	FUNC:PHOT:DAY:DATA_1_1_1_300000	Write 1 st day trend data set: MPP voltage: 1 V MPP current: 1 A Dwell time: 5 minutes	12010
12	FUNC:PHOT:DAY:DATA_2_2_2_500	Write 2 nd day trend data set: MPP voltage: 2 V MPP current: 2 A	12010

Nr.	Command	Description	Register
...	...	Write further data set, a total of 1000	...
1010	FUNC:PHOT:DAY:DATA_1000,_30,_9,_500	Write 1000th day trend data set: MPP voltage: 30 V MPP current: 9 A	12010

Due to the dwell time of 5 minutes in the very first day trend data set, all 1000 data sets use the same dwell time, so the total simulation time results as 5000 minutes.

Nr.	Command	Description	Register
1011	FUNC:PHOT:STAT_RUN	Start simulation -> the simulation will stop automatically after the time that results from the total of dwell times in all written data sets	12000

7.13 Profibus & Profinet

7.13.1 General

The interface modules IF-AB-PBUS (Profibus) or IF-AB-PNET (Profinet, 1 or 2 ports) simplify use and implementation of the unit to the absolute minimum. When using Profibus, the user only has to set the slave address (0...125) on the unit (setup menu), while Profinet is best set up using the Siemens Primary Setup Tool (PST). All other parameters like tags, which can be defined in the unit's setup menu or via command, are optional.

This section of the manual will only explain how to use the separate PDF register list for your unit series. The list should be along with this document and is the reference for the remote access to the unit.

The interface modules define a DP-V1 slave for cyclic and acyclic data transmission.

7.13.2 Preparation

For the implementation of the unit into a Profibus or Profinet and the enumeration at the master (PLC or similar), a fully configured and wired unit is presumed. The next thing you will need is a unit description file called GSD (Generic Station Default) for Profibus or a GSDML for Profinet/IO, which is either delivered with the unit or is available as download from the manufacturer's web site or can be obtained upon request.

This GSD/GSDML file enables to build a specific slot configuration for cyclic process data, such as actual values or status. Those slots are also used to access other data objects of the unit via acyclic read/write. See more below.

7.13.3 Slot configuration for Profibus

The slot configuration for users of the interface module IF-AB-PBUS is done by loading the GSD/GSE file in the configuration dialogue (with Siemens STEP7: HWCONFIG) and by arranging the slots in a specific order.

Slot	Slot name	Description
1	Device status & acyclic slot 1	Cyclic: Unit status (see register list) Acyclic: all registers (indexes) assigned to slot 1

Slot	Slot name	Description
2	Act. voltage & acyclic slot 2	Cyclic: Actual voltage of DC input/output Acyclic: all registers (indexes) assigned to slot 2
3	Act. current & acyclic slot 3	Cyclic: Actual current of DC input/output Acyclic: all registers (indexes) assigned to slot 3
4	Act. power & acyclic slot 4	Cyclic: Actual power of DC input/output Acyclic: all registers (indexes) assigned to slot 4
5	Acyclic slot 5	Acyclic: all registers (indexes) assigned to slot 5
6	Acyclic slot 6	Acyclic: all registers (indexes) assigned to slot 6
7	Acyclic slot 7	Acyclic: all registers (indexes) assigned to slot 7
8	Acyclic slot 8	Acyclic: all registers (indexes) assigned to slot 8

Transfer of the above table to the HW CONFIG of Siemens Simatic:

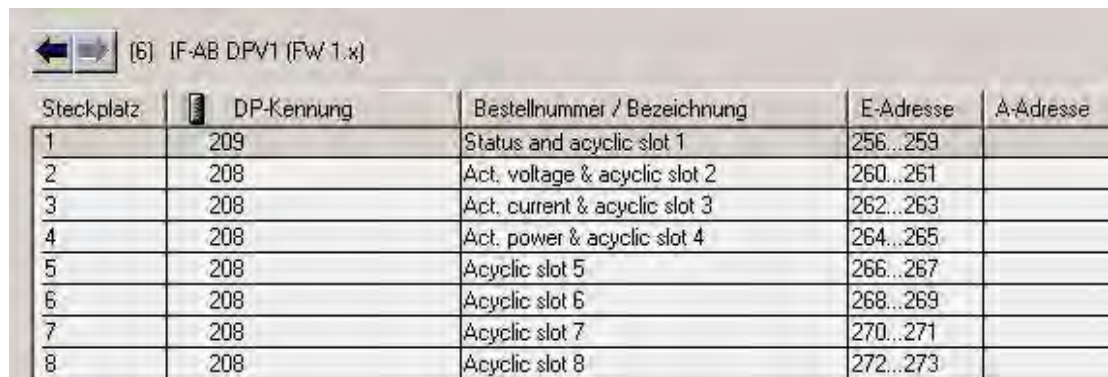

Steckplatz	DP-Kennung	Bestellnummer / Bezeichnung	E-Adresse	A-Adresse
1	209	Status and acyclic slot 1	256...259	
2	208	Act. voltage & acyclic slot 2	260...261	
3	208	Act. current & acyclic slot 3	262...263	
4	208	Act. power & acyclic slot 4	264...265	
5	208	Acyclic slot 5	266...267	
6	208	Acyclic slot 6	268...269	
7	208	Acyclic slot 7	270...271	
8	208	Acyclic slot 8	272...273	

The address ranges can of course be re-arranged as required. The slots for acyclic access don't need an output address range, because the input address range already reserves memory space for both directions.

7.13.4 Slot configuration for Profinet

The GSDML (available from the included USB stick or as download) does not offer automatic slot configuration. When loading the file the correct version for the interface module in use (1 port or 2 port) must be selected. After that, the slot placement has to be done by the user like this:

Slot	Slot name	Description
1	Input 2 words	Cyclic: Unit status (register 505, see register list) Acyclic: all registers (indexes) assigned to slot 1
2	Input 1 word	Cyclic: Actual voltage of DC input/output (register 507, see register list) Acyclic: all registers (indexes) assigned to slot 2
3	Input 1 word	Cyclic: Actual current of DC input/output (register 508, see register list) Acyclic: all registers (indexes) assigned to slot 3
4	Input 1 word	Cyclic: Actual power of DC input/output (register 509, see register list) Acyclic: all registers (indexes) assigned to slot 4
5	Input 1 word	Acyclic: all registers (indexes) assigned to slot 5
6	Input 1 word	Acyclic: all registers (indexes) assigned to slot 6
7	Input 1 word	Acyclic: all registers (indexes) assigned to slot 7
8	Input 1 word	Acyclic: all registers (indexes) assigned to slot 8

Transfer of the above table to the HW CONFIG of Siemens Simatic:

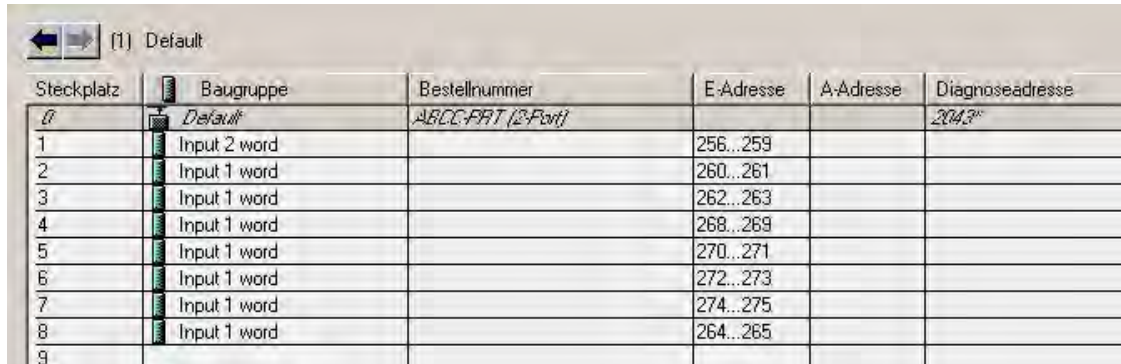

Steckplatz	Baugruppe	Bestellnummer	E-Adresse	A-Adresse	Diagnoseadresse
0	Default	ABCC-FAT (2-Part)			2043
1	Input 2 word		256...259		
2	Input 1 word		260...261		
3	Input 1 word		262...263		
4	Input 1 word		268...269		
5	Input 1 word		270...271		
6	Input 1 word		272...273		
7	Input 1 word		274...275		
8	Input 1 word		264...265		
9					

The address ranges can of course be re-arranged as required. The slots for acyclic access do not need an output address range, because the input address range already reserves memory space for both directions.

7.13.5 Cyclic communication via Profibus/Profinet

The Profibus / Profinet slave cyclically transfers process data to certain input addresses of the master, as defined by the user for Profibus or Profinet. See “Slot configuration for Profibus“ and “Slot configuration for Profinet“.

Actual values have to be translated according to the procedure as described in section 7.5.5, "Translating Set values to Actual values" on page 141, while any other data are referenced in those so-called register lists, which usually should be with this document. The slot names are partially connected to corresponding registers in the lists. For instance, a slot might be named “Actual current“.

There are eight slots for acyclic access to the unit, which are assigned a varying number of indexes (see register lists). Using appropriate SFBs, the user can a-cyclically access the IDs (slot addresses) and indexes by write and read. The additional four slots are only defined to reserve slot address space for acyclic data transfers.

Note: Set values and settable status are not be transferred cyclically for several reasons. One is the high number of available registers, which cannot be covered by only 16 available slots and the max. data size per slot

7.13.6 Acyclic communication via Profibus/Profinet

Acyclic communication with the target unit is done by using slots 1-8, precisely their addresses (ID), and indexes, which are accessed by system function blocks for read or write. The SFBs to use here are usually SFB52 and SFB53 when using Siemens software. Other PLC control software offer similar options.

The SFBs require an ID, an index and a parameter as input. The parameter can be a status or a set value, translated to a hexadecimal value according to section 7.5.5, "Translating Set values to Actual values" on page 141.

For starters we offer example projects (available on request), one each for Profibus and Profinet, which can be opened with Siemens STEP7 and which shall demonstrate the access to the unit with preconfigured data blocks.

The register list for your unit or unit series has two columns, related to Profibus/Profinet use only. These define slot and index number for a particular command. The necessary parameter is defined in the register lists respectively in section 7.5.5, "Translating Set values to Actual values" on page 141. Rule of thumb:

Commands, where no slot/index is given, are not supported via Profibus or Profinet

The general procedure to control a unit remotely is like this:

1. Activate remote control with the appropriate command (can be denied by the slave, see section 6.5.2, "Control Locations" on page 102)
2. Control and monitor your unit remotely as long as required
3. Deactivate, i.e. leave remote control

If you just want to record data by reading values from the unit, activation of remote control is not necessary. You can send query commands to the unit at any time and the unit will respond immediately, if the current unit situation allows the unit to respond at all.

When querying something from the unit, the function block will put out the data returned from the unit to an output buffer. That data can then be processed.

The field bus ensures that the command is transmitted to the slave unit, otherwise it will generate an error. However, it cannot verify that the unit really accepts the command or already has set the desired value. This can only be verified by reading the value from the unit and comparing. Whether a value has been transferred to the unit's DC input / output cannot be determined definitely.

In order to send a command from with a typical Profibus/Profinet software, following should be applied:

1. Select the command to use from the register list and read its assigned slot/index values.
2. Determine the I/Q address which is assigned to the particular slot in HWCONFIG and which is used to get an ID value. The use of ID, index, slot and sub-slot are not just different between Profibus and Profinet, but also between the different PLC systems and software.

The examples below demonstrate:

1. Set ID, index and parameter (set value, status or something else) in decimal or hexadecimal form in the SFB and execute.
2. Process the data returned from the unit, if the last command was a query

7.13.7 Examples for acyclic access

7.13.7.1 Activate/deactivate remote control

Remote control is a unit state and not the default one. It has to be activated, i.e. requested by the user before the unit can be controlled remotely. Depending the settings and on the state the unit is currently in when trying to switch to remote control, the unit can deny the request.

How to activate or deactivate remote control of your unit via Profibus:

1. Use the register list and find the proper command, here: Register 402 - Remote mode.
2. Find the slot and index values for this command in the dedicated columns, here slot 2 and index 1.
3. From the slot configuration read the I/Q address for slot 2 to have the value for parameter "ID", for example
 - a. 260 (like in the earlier Slot Configuration examples) or DW#16#104
4. The value "Index" from the register list is submitted to the parameter INDEX like this:
 - a. Profibus: INDEX = Index = 1
 - b. Profinet: INDEX = Slot number * 255 + 1 + Index = 510 + 1 + 1 = 512
5. Use a suitable function block in your automation software, for example SFB53.
6. Define the control value to use for this command, as described in the columns "Data" and "Example":
 0xFF00 = Activate remote control
 0x0000 = Deactivate remote control
7. Configure the function block with ID, INDEX and control value and execute the block. If not somehow inhibited by the unit, it should either switch to remote control or back to manual control.

7.13.7.2 Send a set value

Any command that sets something in the unit, no matter if value or status, requires activated remote control status. Also see "Activate/deactivate remote control" and 6.5.2,"Control Locations" on page 102.

Before you send a value, you first need to select which one you want to set and you also might need to translate it, because via Profibus/Profinet set values are transferred as percent of the nominal values. Read sections "Format of set values and resolution" and section 7.5.5, "Translating Set values to Actual values" on page 141 for more information.

How to set the DC input/output current value:

1. Use the register list and find the proper command, here: Register 501 - Set current value.
2. Find the slot and index values for this command in the dedicated columns, here slot 2 and index 24.

3. From the slot configuration read the I/Q address for slot 2 to have the value for parameter "ID", for example 260 (like in the earlier Slot Configuration examples) or DW#16#104
4. The value "Index" from the register list is submitted to the parameter INDEX like this:
Profibus: INDEX = Index = 25
Profinet: INDEX = Slot number * 255 + 1 + Index = 510 + 1 + 24 = 535
5. Use a suitable function block in your automation software, for example SFB53.
6. Define the control value to use for this command, as described in the columns "Data" and "Example":
0x0000...0xCCCC (decimal: 52428) = Current 0...100%.
For a model with, for example, 170 A nominal current and a desired current of 10 A, this would be 1/17 of nominal, thus 52428/17 = 3084 --> 0x0C0C.
7. Put the control value 0x0C0C together with ID and INDEX into the function block and execute the block. The unit should instantly set 10 A as current limit. This can be verified in the display of the unit where it shows the set value of current

7.13.7.3 Read something

Reading something from the unit is always possible, it means that no remote control is required. Apart from the cyclically transferred data, any other available information can be read via acyclic transfer.

How to read the actuals values of voltage and current;

1. Use the register list and find the proper register. The registers of voltage and current are next to each other, the one of voltage is the lower number, thus it will be:
Register 507 - Actual voltage
2. Find the slot and index values for this command in the dedicated columns, here slot 2 and index 28
3. From the slot configuration read the I/Q address for slot 2 to have the value for parameter "ID", for example 260 (like in the earlier Slot Configuration examples) or DW#16#104.
4. The value "Index" from the register list is submitted to the parameter INDEX like this:
Profibus: INDEX = Index = 28
Profinet: INDEX = Slot number * 255 + 1 + Index = 510 + 1 + 28 = 539
5. Read the length of bytes from the column "Data length in bytes" to determine how many bytes to read. In this case, there are two registers with length 2 bytes to read, so it is 4 bytes.
6. Use a suitable function block in your automation software, for example SFB52.
7. Configure the function block with ID, INDEX and data length (4 bytes or 2 word, depending in the way the software defines the input).
8. Execute the function block. The data buffer of the block should return the requested data in form of 20 bytes.

The returned 4 bytes will contain the actual voltage value in the first two bytes and is represented as percent value. The actual current values will be in the last two bytes.

By varying the data length to 6 you could also include the actual power value. Alternatively, you can query each actual value separately. To do this, you need to use the corresponding register number for parameter INDEX and a data length of 2.

7.13.8 Data interpretation

Data returned from queries, but cyclically transferred data in the first place, have to be interpreted. Let us use an example from a Profibus master simulator where the cyclic data is comfortably displayed. Also see section 7.5.5, "Translating Set values to Actual values" on page 141.

This is the cyclically transferred data of 8 slots, as defined in the GSD/GSDML.

Eingangsdaten			
76543210			
1:	00	00000000	. 0
2:	00	00000000	. 0
3:	04	00000100	. 4
4:	C0	11000000	. 192

5:	26	00100110	. 38
6:	3A	00111010	: 58

7:	0C	00001100	. 12
8:	9B	10011011	. 155

9:	09	00001001	. 9
10:	25	00100101	% 37

11:	00	00000000	. 0
12:	00	00000000	. 0

13:	00	00000000	. 0
14:	00	00000000	. 0

15:	00	00000000	. 0
16:	00	00000000	. 0

17:	00	00000000	. 0
18:	00	00000000	. 0

Only slots 1-4 are used, so the rest remains empty.

Slot 1: Unit status (connected to register 505). The value 0x000004C0 says that bits 6, 7 and 10 are set. It means, the unit is configured as master (for master-slave), the input/output is on and regulation mode is CC.

Slot 2: Actual voltage (connected to register 507). With a 250 V model, for instance, the value 0x263A translates to 250 V*0x263A/52428=46.7 V.

Slot 3: Actual current (connected to register 508). With a 510 A model, for instance, the value 0x0C9B translates to 510 A*0xC9B/52428=31.4 A.

Slot 4: Actual power (connected to register 509). For a 5 kW power supply, for instance, the value 0x0925 translates to 5000 W*0x925/52428=223 W or 0.22 kW.

Slot 5: not used for cyclic data

Slot 6: not used for cyclic data

Slot 7: not used for cyclic data

Slot 8: not used for cyclic data

7.14 CANopen

For CANopen available communication objects or registers, indexes are defined in an Electronic Data Sheet file (EDS/XDD), which is delivered with your unit on a CD or available upon request. This EDS can be integrated in special CANopen related software. The CANopen indexes are not separately explained, because their definition and use is identical to herein described ModBus protocol and the related, external register list files.

The difference is only that the ModBus register addresses count up from 0 and with CANopen, according to the standard and the interface specification of the manufacturer, the user indexes are located from 0x2001. It means, the register addresses as listed in decimal form in those register list are shifted by the value 0x2001 (8193). Examples from the ModBus part of this document can be used and applied for CANopen as well, but reduced to the core data, because CANopen is not confronted with checksums and function codes as is ModBus.

Note: The CANopen module IF-AB-CANO does not feature an internal termination resistor. Thus the required bus termination resistor has to be applied by the user according to the CAN bus requirements.

7.14.1 Preparation

For the communication with the unit via CANopen interface IF-AB-CANO, a few things are required:

1. A suitable CAN cable, preferably with switchable termination resistor, which has to be activated, always if the unit is at the end of the bus, like when directly connecting the PC to a single ELR 9000 unit.
2. EDS/XDD (usually provided along with this document).
3. CANopen software for the PC (not included, any available software for CANopen should suffice).
4. Documentation about how to use the supported indexes. See the included register list(s).

7.14.2 User objects (indexes)

The message format used via CANopen communication is related to ModBus. A specific index is connected to a specific ModBus register. The CANopen standard defines that user objects are enumerated from index 2001. With ModBus, the registers are counted from 0. It means, that index 2001 corresponds to register 0 or index 21F5 corresponds to register 500 etc.

The EDS/XDD contains less indexes than the unit supports ModBus registers. But the available indexes still cover the most functions of the unit to be used via remote control.

Along with this document there usually are so-called register lists for primary ModBus use, but these can also be used for CANopen, as they also define data type and value range of the indexes. Examples in other sections of this documents can be applied for CANopen as well.

7.14.3 Translation ADI -> register

The translation of an CANopen index, as listed in the EDS file, to a register address is quite easy due to the fixed offset 0x2001. For example, if you pick the index "207A Nominal voltage" from the EDS, it translates like this:

Index number - Offset = register address --> $0x207A - 0x2001 = 0x79$ (hex) = 121 (dec). Because CANopen does not support the data type FLOAT, the EDS uses REAL32 here. The user just has to translate the 32-bit value according to IEEE 754 specification.

7.14.4 Specific examples

7.14.4.1 Switching to remote control

As described in “Switch to remote control or back to manual control”, it is required to switch the unit to remote control before you can control it. In order to do this, you first need to find the proper command, i.e. register in the register list resp. the dedicated index in the EDS. In this case, it is register 402 resp. index $0x2193$. The register list defines that the value $0xFF00$ has to be sent to switch to remote or value $0x0000$ to leave remote control.

7.14.4.2 Setting a set value

After remote control has been accepted by the unit, you are allowed to send set values. Those values usually represent a per cent value. From the definition in the register list, the hexadecimal value $0xCCCC$ translates to 100% and $0x0000$ to 0%. It means, there are 52428 possible values between 0% and 100%. It has to be pointed out here, that this is not the resolution a unit value like voltage or current can have at the DC input/output. The effective resolution of output/input values is 26214 steps. An example for set value translation is in “Writing a set value”.

7.14.5 Using the arbitrary generator

Due to CANopen only being able to transport a maximum of 4 user data bytes per message, the 8 values of sequence point data for the sequence points of the arbitrary generator cannot be transferred at once, but in 8 separate messages. The unit checks every single value for plausibility when sent, but once all sequence points are set without error it requires to send an additional submit command (index 235F). This will transfer the sequence point data and load the function for start/stop action. Without sending that command the function generator would either run with all data being zero or using former data.

The steps to perform, as described in section 4.10.7.1, are the same for CANopen, except for the addition of step 3.1:

- Step 1: Select, whether to apply the function to the voltage U (index 2354) or the current I (index 2355). Before you have not made this selection, the unit cannot accept sequence point data, because the data is run through a plausibility check against the unit’s nominal values.
- Step 2: Define start sequence point (index 235C), end sequence point (index 235D) and number of cycles of that sequence point block to repeat (index 861).
- Step 3: Load data for all required sequence points (x out of 99, indexes 2385 - 29A5, 8 values per sequence point in sub-indexes).
 - Step 3.1: Submit the data by writing $0xFF00$ to index 235F (register 862, undocumented for ModBus, because not required there)

- Step 4: Set global voltage limit (index 21F5), if the function is applied to the current. Else set global current limit (index 21F6), if the function is applied to voltage. Set global power limit (index 21F7) for both modes.
- Step 5: Control the function generator with start/stop (index 2353).
- Step 6: When finished, leave the function generator by deselecting your former selection of either U (index 2354) or I (index 2355) again by writing 0x0000.

7.14.6 Error codes

Following error codes, as part of the CANopen standard, are supported by the CANopen interface module.

Code	Description
0x06020000	Object does not exist in the object dictionary (ModBus register list)
0x06040043	Command not supported
0x06099911	Sub-Index does not exist
0x06010002	Attempt to write a read only object
0x06010002	Attempt to read a write only object
0x06070012	Too much data
0x06070013	Not enough data
0x06090030	Value range of parameter exceeded
0x08000022	Data could not be transferred or stored to the application because of the present unit state
0x05040005	Out of memory
0x08000000	General error

7.15 CAN Bus

This section is solely dedicated to the communication with a unit via the CAN interface IF-AB-CAN. Configuration of the interface itself is done on the control panel (HMI) of the unit.

7.15.1 Preparation

Communication with the unit via CAN module IF-AB-CAN requires a few things:

1. A suitable CAN cable. It is not required to have one with integrated bus termination switch and resistor, because the interface module has an electronic switch and resistor for bus termination. In case the cable also has one, it is important to take care to activate only one of both, else there can be bus errors.
2. When using Vector™ or similar software which can make use of so-called database files (DBC), a dedicated DBC for the particular unit model. If not available, it can be requested from the manufacturer or created by the user.
3. CAN software for the PC (not included, any available software for CAN should suffice).
4. Documentation about how to use the supported CAN objects. See below and sections 1. - 4., as well as the included register list(s).

7.15.2 Introduction

The data format is derived from the previously in this document described ModBus RTU. In relation to a database file (DBC) a mux value (Vector terminology) represents a specific ModBus register or object/command. Objects in the database are thus selected by the multiplexer and when programming CAN directly, the first two bytes of data in a CAN message define the register, i. e. object to access. The selection between writing and reading objects is done by the CAN ID.

Each unit will be assigned three CAN IDs, which are adjusted with the so-called base ID on the unit's CAN settings. The base ID is used write to objects (message: Send_Object), while querying objects (message: Query_Object) is done with base ID +1 and responses (message: Read_Object) coming from the unit use base ID + 2.

Responses are either expected after a query, but can also be unexpected in case of communication or access error. When adjusting the base ID of a unit, the related IDs will shift automatically.

There is another adjustable ID, the broadcast ID. It is separate from the others and can be used to access multiple units at once with one command when adjusting the broadcast ID to the same value on all units. This ID is for write access (Send_Object) only. Queries to multiple units at once with one message are not possible.

Apart from the base ID and broadcast ID for acyclic access there are further IDs to adjust for the cyclic data which can be sent by the unit after being activated. Refer to the user manual of your unit, particularly the section for the communication settings.

7.15.3 Message formats

Note: Below explanations are, besides the selection of IDs to switch between write and read actions, also related to the ModBus functions, as listed in the register lists in columns 2-6.

7.15.3.1 Normal sending (writing)

Writing to the unit always used the base ID or the broadcast ID. It requires to define the first register/object to write to in the CAN data, as well as the number of registers to write and a specific number of parameter bytes which can represent different data types.

Access: Base ID, broadcast ID

ModBus function: Write Single Coil (WSC), Write Single Register (WSR):

Bytes 0+1	Byte 2	Bytes 3+4
Register	Nr. of regs to write	Data
0...65534	Always 1	Value (16 bit)

Access: Base ID, broadcast ID

ModBus function: Write Multiple Registers (WMR)

Bytes 0+1	Byte 2	Byte 3	Bytes 4-7
Start reg.	Nr. of regs to write	Marker	Data bytes
0...65534	2...123	0xFF, 0xFE...	Four bytes or two 16 bit values or one 32 bit value

Start register: always the register number from the register list, i. e. start register, even for WMR.

Nr. of regs to write: refer to the register list. Every object has a starting register and a certain number of total registers, which form the object. An object defined with 40 bytes occupies 20 registers, so when writing to such an object the value here would have to be 20.

Marker: is used to distinguish single messages from split messages and to detect the correct sequence of data. For example, a string like the user text can be up to 40 characters long and when writing it has to be split across multiple messages. Every message can transport 4 bytes of register data. The marker always starts with 0xFF and is counted downwards (0xFF, 0xFE...) with every next split message belonging to a transmission. The marker is required, because on CAN bus it is not guaranteed that messages are received in the same order they were sent.

Data bytes: the number of bytes in this type of message is always 4, no matter if all bytes are filled with information from the actual data to transmit or are 0. An example: an user text with a length of 15 characters would require to send at least 4 messages. The object for the user text is defined to have 20 registers, means 10 messages. You can choose to either write the full 40 bytes while the rest of bytes in the transmission would be zero or to reduce the number of message to the minimum of 4, i. e. a value of 8 for Nr. of regs to write.

7.15.3.2 Cyclic sending (writing)

Cyclic sending or cyclic writing is very similar to normal sending, but it's more time effective and intended for often used objects like set values. It offers the possibility to send all four set values to the unit at once. It requires two extra CAN IDs to be reserved. The user defines the interval of send actions with the CAN software, no matter if normal or cyclic sending. But there are also limits. The timing as described in section 3.3.3 also applies here.

In order to use this feature, the user only has to define the separately adjustable "Base ID Cyclic Send" and can then send two different messages with following format:

Access: Base ID (Control)

Bytes 0-1
Control word

Control word definition:

Bit	Name	Related register	Meaning
0	Remote control	402	Activates remote control of the unit with 1 or deactivates it with 0
1	Input/Output	405	Switches the DC input/output of the unit on with 1 or off with 0
2	UIP / UIR	409	Activates resistance control mode (UIR) with 1, while with 0 mode UIP will be active
3	Alarm	411	A 1 acknowledges all currently acknowledgeable alarms

Note: This control word requires special attention, as the 5 bits can trigger several actions at once, which don't have a certain priority of processing. It means, if you would try to activate remote control together with switching on the DC input/output (bits 0 and 1 both TRUE), you may receive a settings conflict error, because the unit would possibly process bit 1 before bit 0.

Access: Base ID Cyclic Send + 1 (Set values).

Bytes 0-1	Bytes 2-3	Bytes 4-5	Bytes 6-7
Register 500	Register 501	Register 502	Register 503
Set value of voltage	Set value of current	Set value of power	Set value of resistance

7.15.3.3 Querying

Querying an object is the first part of a read action. It is always done via base ID + 1. The unit should then respond via base ID + 2 (Read_Object) and with the expected data. Only after reading the response, the read action is finished. In order to query an object via the query ID (base ID +1) it is sufficient to just sent the start register number.

Access: Base ID + 1

ModBus functions: Read Coils (RC), Read Holding Registers (RHR).

Bytes 0+1
Start reg.
0...65534

7.15.3.4 Normal reading

Data coming from the unit can be one message (expected or error) or split messages, forming a response. The information is either in a buffer or, when using Vector software, automatically sorted into signals. The data of split messages has to be combined again according to the marker. Even the Vector database cannot do this automatically. But there are only a few objects like the user text which require this treatment and these are usually not accessed very often.

Depending on the length of expected data, a response can be split into multiple messages. Those split messages use an extra marker.

Access: Base ID + 2

Response with one message (number of queried registers 1-3):

Bytes 0+1	Bytes 2-7
Register	Data
0...65534	1-3 registers

Response with multiple messages (number of queried registers >3):

Bytes 0+1	Byte 2	Bytes 3-7
Register	Marker	Data
0...65534	0xFF, 0xFE...	5 bytes

Response as error message:

Bytes 0+1	Byte 2
65535	Error code

The error codes used here are the same as with ModBus. See section 7.9.4, “Communication Errors”.

7.15.3.5 Cyclic reading

The cyclic read feature is an extended function where the unit can automatically send specific objects to specific IDs and in a specific interval. Cyclic read messages differ from those of normal read actions.

In order to activate and use cyclic read, the user has to:

1. Set the separate base ID for cyclic read on the unit (HMI, CAN settings).
2. Define which of the 5 available objects for cyclic are going to be used and activate them by setting the interval time to a value other than zero.

The interval times for the 5 objects can be separately and arbitrarily. In case they match or overlap, the unit will send the corresponding messages subsequently and as fast as possible.

Note: The minimum interval is 20 ms. When using very low CAN bus speed, for example 10-50 kbps, a CAN bus error may occur because of too much traffic.

Once cyclic read is activated by setting the interval time of at least available object to other than 0 and as soon as a CAN connection is established, the unit will start to automatically and permanently send messages to the defined IDs. While the CAN connection is open, the cyclic read feature can be turned off or on at will using the CAN settings on the HMI or the corresponding commands.

There are 5 IDs to reserve for cyclic read. Starting at the adjustable "Base ID Cyclic Read" (see Front panel operation of the unit) the data in the messages is defined as follows:

Access: Base ID Cyclic Read (Status).

Bytes 0-3
Device status (32 Bit)

Bit configuration of the device status value:

Bit	Name	Meaning	Bit	Name	Meaning
31	Remote control	1 = on	15	-	
30	Input / output	1 = on (req., register 405)	14	Alarm OVD	1 = alarm active
29	Volt. reg. speed	1 = fast (register 422)	13	Alarm OVP	1 = alarm active
28	UIP/UIR	1 = UIR (Register 409)	12	Alarm PF	1 = alarm active
27	Alarms	1 = at least 1 alarm active	11		
26	Alarm MSS	1 = alarm active	10		
25	Alarm OCD	1 = alarm active	9	REMSB	1 = on (register 505, bit 30)
24	Alarm OCP	1 = alarm active	8	Alarm UCD	1 = alarm active
23	Interface in access	register 505, bits 4-0	7	Alarm UVD	1 = alarm active
22			6	Remote sensing	1 = external, 0 = internal
21			5	Function gen.	1 = FG active
20			4	MS type	1 = master, 0 = slave
19			3	Input / output	1 = on (register 505, bit 7)
18			2	Reg. mode	Register 505, bits 10-9
17	Alarm OPD	1 = alarm active	1		
16	Alarm OPP	1 = alarm active	0	-	
16	Alarm OT	1 = alarm active			

Access: Base ID Cyclic Read + 1 (Actual values).

Bytes 0-1	Bytes 2-3	Bytes 4-5
Register 507	Register 508	Register 509
Actual voltage	Actual current	Actual power

Access: Base ID Cyclic Read + 2 (Set values)

Bytes 0-1	Bytes 2-3	Bytes 4-5	Bytes 6-7
Register 500	Register 501	Register 502	Register 503
Set value of voltage	Set value of current	Set value of power	Set value of resistance

Access: Base ID Cyclic Read + 3 (Adjustment limits 1)

Bytes 0-1	Bytes 2-3	Bytes 4-5	Bytes 6-7
Register 9002	Register 9003	Register 9000	Register 9001
I-max	I-min	U-max	U-min

Access: Base ID Cyclic Read + 4 (Adjustment limits 2)

Bytes 0-1	Bytes 2-3
Register 9004	Register 9006
P-max	R-max

7.15.4 Message examples

7.15.4.1 Switching to remote control

As described in section 7.9.5.1, “**Switch to Remote Control or back to Manual Control**“, it is necessary to switch the unit to remote control before you can control it. In order to do this, you first need to find the proper command, i.e. register in the register list resp. the dedicated index in the EDS. In this case, it is register 402 (hex: 0x192). The register list defines that the value 0xFF00 has to be sent to switch to remote or value 0x0000 to leave remote control.

Assuming the unit would have been set to base ID 0x100, the data to be sent according would be:

0x01	0x92	0x01	0xFF	0x00
Register/ object	Nr. of regs	Bit (coil) for TRUE		

The unit should then switch to remote control, if not inhibited somehow. The status of remote control can be read from the display or by reading another object.

7.15.4.2 Write and read back a set value

After remote control has been accepted by the unit, you are allowed to send set values. Those values usually represent a per cent value. From the definition in the register list, the hexadecimal value 0xCCCC translates to 100% and 0x0000 to 0%. It means, there are 52428 possible values between 0% and 100%. It has to be pointed out here, that this is not the resolution a unit value like voltage or current can have at the DC input/output. The effective resolution of output/input values is 26214 steps. An example for set value translation is “Writing a set value“.

Power supply model DCS80-170 has a nominal current of 170 A. If you wanted to set it to 35 A, the set value according to the formula calculates as: $35 \text{ A} * 52428 / 170 \text{ A} = 10794 = 0x2A2A$. The current is set with register 501. Assuming the unit would have been set to base ID 0x88, the data to be sent to ID 0x88 according would be:

0x01	0xF5	0x01	0x2A	0x2A
Register/ object	Nr. of regs	Set value current		

As soon as the unit accepts the value, it is set and could be read from the display or by reading it back using the same object. With the same base ID, the query message would be:

0x01	0xF5
Register object	

and would have to be sent to the query ID of the unit, here 0x89. Shortly after this, the unit should respond with the requested value on the read ID 0x8A:

0x01	0xF5	0x2A	0x2A
------	------	------	------

Register Set value
object current

In case the values has not been accepted when sending it, for example because the adjustment limit for current (I-max) has been set to 30 A, the unit may have responded with an error message instead of the expected one:

0x01	0xF5	0x03
------	------	------

Error Error
 code

The ModBus error code 0x3 indicates "wrong data". In this case, the set value was too high.

7.16 EtherCAT

7.16.1 Introduction

Available on EtherCAT module IF-AB-ECT. Per definition, the EtherCAT data communication is based on CANopen, thus also called "CANopen over Ethernet (CoE)". All documentation for EtherCAT and CANopen is provided by the Beckhoff company resp. the CiA organization.

Below we will refer anything related to software to Beckhoff's TwinCAT.

7.16.2 Integrating your unit in TwinCAT

You will need an ESI file, an EtherCAT unit description in XML format. This file can be obtained upon request. The file stored in a dedicated folder in the TwinCAT installation. Default path:

C:\TwinCAT\\Config\Io\EtherCAT\

After installing this file and restarting the TwinCAT IDE, our EtherCAT slaves can be integrated into the setup with the "Insert EtherCAT Unit" dialog and by selecting the unit name "IF-AB-ECT":

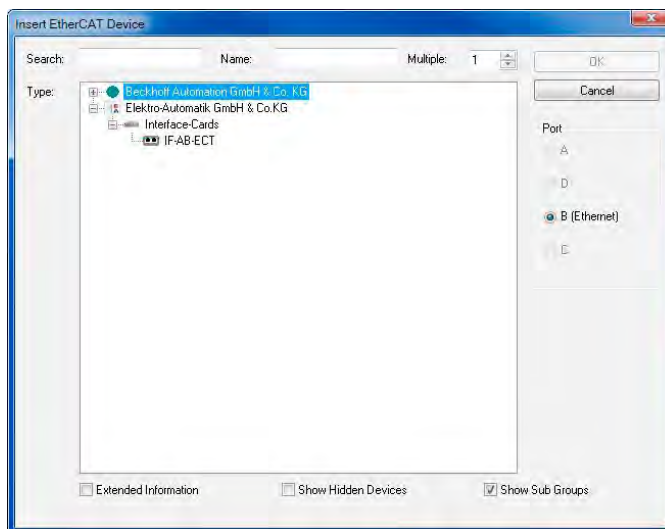

Further slaves can be added with the same method.

7.16.3 Data objects

The units internally use ModBus protocol and for CANopen over Ethernet communication in both directions, the messages are translated. This is why the reference for all cyclical data (PDOs) and acyclical data (SDOs) are those ModBus register lists. They are available as download. The acyclical objects are downloaded from the unit when accessing an online EtherCAT slave in tab "CoE" in TwinCAT. Offline objects in form of an EDS file are not available.

Together with the PDOs defined in the ESI file the complete list of indexes then becomes accessible and enable the user to completely control the unit.

There is a connection between the CoE indexes and the ModBus register numbers in the lists. You can translate both back and forth.

► **Translating ModBus register ► CANopen index**

ModBus register number in decimal + 8193 ► convert to hexadecimal = index

Example: You want to set the unit into remote control mode and want to find the corresponding CoE index. In the register list you have register number 402 for this task. Calculation: $402 + 8193 = 8595$ ► converted to hexa- decimal it is 0x2193, hence index 2193.

► **Translating CANopen index ► ModBus register**

CANopen index in hexadecimal - 0x2001 ► convert to decimal = register

Example: you need know the meaning of the bits in the PDO "Status". Find the corresponding CoE index in the index list. Here it is 21FA. Calculation: $0x21FA - 0x2001 = 0x1F9$ ► converted to decimal it is 505. In the register list you will find register number 505 and the layout of the 32 bit value.

7.16.4 PDOs

The unit description file defines for our EtherCAT slaves the same set of PDOs:

Name	EtherCAT data type	Length in bytes	ModBus register	Short description
Status	UDINT	4	505	Unit status
Voltage Monitor	UINT	2	507	Actual voltage on DC input/output (in per cent)
Current Monitor	UINT	2	508	Actual current on DC input/output (in per cent)
Voltage select	UINT	2	500	Set value of voltage (in per cent)
Current select	UINT	2	501	Set value of current (in per cent)
Power select	UINT	2	502	Set value of power (in per cent)
Resistance select	UINT	2	503	Set value of resistance (in per cent)

7.16.5 SDOs

The acyclic data objects for use in the EtherCAT system are defined in your unit and can be downloaded from it. It requires the unit to be online with the EtherCAT system. There is no separate documentation for the down- loadable data objects. Like with CANopen (see section 7.14, "CANopen" on page 208), the register lists which are part of the programming documentation are the reference for the SDOs to explain data content and function.

7.16.6 Use of the data objects

Please refer to section 7.14.2, "User objects (indexes)" on page 208".

8 Master/Slave (M/S) Operation

8.1 Parallel Operation

Multiple units of same kind and model can be connected in parallel in order to create a system with higher total current and hence higher power. This can be done using the standard models with display and control panel or the slave DCS models. These models are intended to run as a slave only and thus have no TFT display.

Note: The slave models are only available as 15 kW versions, so they only match the 15 kW standard models.

For parallel operation in master-slave mode the units are usually connected with their DC outputs, their Share bus and their master-slave bus, which is a digital bus that makes the system work as one big unit regarding adjusted values, actual values and status.

The Share bus is intended to balance the units dynamically in their output voltage, i.e. in CV mode, especially if the master unit runs a function like sine wave etc. In order for this bus to work correctly, at least the DC minus poles of all units have to be connected, because DC minus is the reference for the Share bus.

Principle view (the rear view shows slave units from this series):

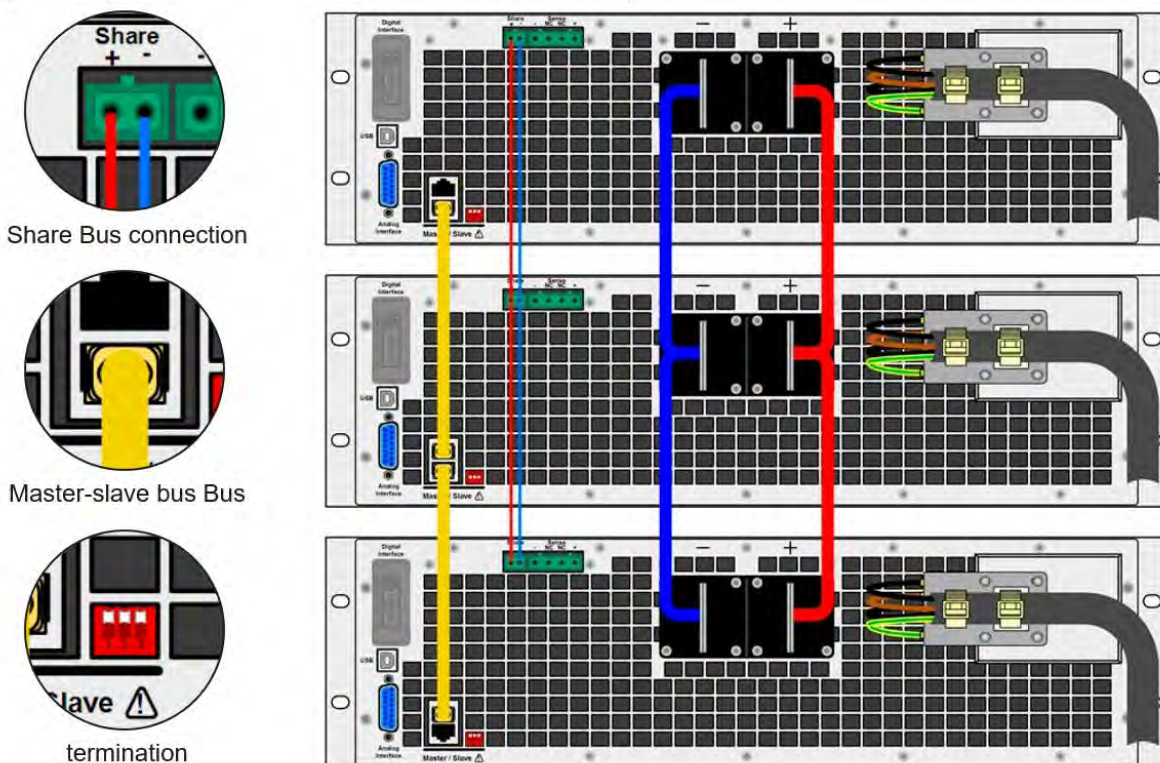

8.1.1 Restrictions

Compared to normal operation of a single unit, master-slave operation has some restrictions:

- The MS system reacts partly different in alarm situations (see below in section 8.1.6).
- Using the Share bus makes the system react as dynamic as possible, but it is still not as dynamic as single unit operation.

8.1.2 DC Output Wiring Parallel Mode

The DC output of every unit in the parallel operation must be connected with correct polarity to the next unit, using cables or copper bars with a cross section according to the total system current and with the shortest possible length.

8.1.3 Wire Sizing for Share Bus

The Share bus must be wired from unit to unit using twisted pairs of cables with non-critical cross section. Recommend wire size to use is 0.5 mm² to 1.0 mm².



Note: The Share bus is poled. Take care for correct polarity of the wiring!

Note: In order for the Share bus to work correctly, all DC minus outputs of the units must be connected together.

Note: A maximum number of 32 units can be connected via the Share bus.

8.1.4 Wiring and set-up of the Digital Master/Slave bus

The master-slave connectors are built-in and can be connected via network cables (\geq CAT3, patch cable). After this, M/S systems can be configured manually (recommended) or by remote control. The following conditions applies:

- A maximum of 32 units can be connected via the bus: 1 master and up to 31 slaves.
- Only units of same kind, i.e. power supply to power supply, and of the same model, such as DCS80-170-2 3U to DCS80-170-4 3U.
- Units at the end of the bus must be terminated (see below)



Note: The master-slave bus must not be wired using crossover cables!

Later operation of the MS system implies:

- The master unit displays, or makes available to be read by the remote controller, the sum of the actual values of all the units
- The ranges for setting the values, adjustment limits, protections (OVP etc.) and user events (UVD etc.) of the master are adapted to the total number of units. Thus, if e.g. 5 units each with a power of 5 kW are connected together to a 25 kW system, then the master can be set in the range 0...25 kW.
- Slaves are no operable as long as being controlled by the master
- Slave units will show the alarm "MSP" in the display as long as they not have been initialized by the master. The same alarm is signaled after a connection drop to the master unit occurred.

- In case the function generator of the master unit is going to be used, the Share bus must be connected as well



How to connect the digital master-slave bus:

1. Switch off all units that are to be connected and connect them with network cables (CAT3 or better, cables not included). It does not matter which of the two master-slave connection sockets (RJ45, rear panel) is connected to the next unit.
2. Depending on the desired configuration the units can then be connected at the DC side. The two units at the beginning and end of the chain should be terminated, if long connection cables are used. This is achieved using a 3-pole DIP-switch, which is positioned on the rear panel of the unit next to the M/S connectors.



Now the master-slave system has to be configured on each other unit. It is recommended to configure all the slave units first and then the master unit.

Step 1: Configuring all slave units (standard DCS Series models with display)

1. Enter  then GENERAL SETTINGS and press  until reaching PAGE 8.
2. Activate the MS mode with touch area . A warning requester will appear which has to be acknowledged with OK, otherwise the change will be reverted.





3. Accept the settings with the touch area  and return to the main page.

Step 1: Configuring all slave units (DCS Series Slave models without display):

1. Connect the Slave series model via the rear USB port or via Ethernet interface to a PC.
2. Start the software EA Power Control (included with the unit on USB stick) and let the software find the unit.
3. Open the app “Settings” for the particular unit, change to tab “Master-Slave” and there set the parameter “Master-slave mode” to “SLAVE”. The slave address is not required to be set, if shown (depending in the version of the software).

The slave now then configured for master-slave. Repeat the procedure for all other slave units.

Step 2: Configuring the master unit:

1. Enter  then GENERAL SETTINGS and press  until reaching PAGE 8.
2. Specify the unit as master with tough area . A warning requester will appear which has to be acknowledged with OK, otherwise the change will be reverted.



- Accept the settings with the touch area **ENTER** and return to the main page.

Step 3: Initializing the master:

The master unit and the whole master-slave system must now be initialized. This is done automatically after the master unit has been activated for M/S operation. In the main page, after quitting the setting menus, a pop-up will appear (see image on the right).



Tapping INITIALIZE can be used to repeat the search again, in case the detected number of slaves is less than expected. This can be necessary if not all units are set as SLAVE or the cabling/termination is still not OK. The result window shows the number of slaves and the total current and power of the MS system.

In case there are no slaves found or not present, i.e. not powered, the master will still initialize the M/S system with only itself.

Note: The initialization process of the master and the master-slave system will, as long as M/S mode is activate, be repeated each time the units are powered. The initialization can be repeated at any time via the MENU in GENERAL SETTINGS.

8.1.5 Operating a Master/Slave System

After successful configuration and initialization of the master and slave units, each unit will show its status in the displays. While the master merely shows “Master” in the status area, the slave(s) unit display will continuously display as shown to the right, as long they are in remote control by the master:



This means that as long as a slave unit is controlled by the master, it will not display any set values, but actual values (measured), and it will show the DC output status and possible alarms.

The display on the master unit changes after initialization and all set values are reset. The master now displays the set and actual values of the total system. Depending on the number of units, the total current and power will multiply. The following applies:

- The master can be treated like a standalone unit
- The master shares the set values across the slaves and controls them
- The master is remotely controllable via the analog or digital interfaces
- All settings for the set values U,I and P (supervision, limits etc.) should be adapted to the new total values
- All initialized slave units will reset any limits (U_{Min} , I_{Max} etc.), supervision thresholds (OVP, OPP etc.) and event settings (UCD, OVD etc.) to default values, so these do not interfere with the master settings. As soon as these values are modified on the master, they are transferred 1:1 to the slaves. During operation, a slave may causes an alarm or event rather than the master, due to imbalanced current or slightly faster response time.

Note: In order to easily restore all these settings values to what they were before activating M/S operation, it is recommended to make use of the user profiles (See section 6.4.3.4, “Profiles Menu”, on page 88).

- If one or more slaves reports a unit alarm, it will be displayed on the master and must be acknowledged there so that the slave(s) can continue their operation. Since an alarm causes the DC output to be switched off and can only reinstate automatically after PF or OT alarms, the operator or remote control software will have to turn the output back on again.
- Loss of connection to any slave will result in shutdown of all DC outputs, as a safety measure. The master will report this condition on its display with a pop-up “Master-slave security mode”. Then the M/S system has to be re-initialized, either with or without re-establishing connection to the disconnected unit(s) before.
- All units, even the slaves, can be externally shut down on the DC outputs using the pin REM-SB of the analog interface. This can be used as an emergency off, where usually a contact (maker or breaker) is wired to this pin on all units in parallel.

8.1.6 Alarms and other problem situations

Master-slave operation, due to the connection of multiple units and their interaction, can cause additional problem situations, which do not occur when operating individual units. For such occurrences the following regulations have been defined:

- If the DC part of one or more slave units is switched off due to defect, overheating etc., the whole MS system shuts down the power output and human interaction is required.
- If one or more slave units are cut from AC supply (power switch, blackout, supply under voltage) and come back later, they’re not automatically initialized and included again in the MS system. Then the init has to be repeated.
- If the DC output of the master unit is switched off due to a defect or overheating, then the total master-slave system cannot provide output power and the DC outputs of all slaves are automatically switched off, too
- If the master unit is cut from AC supply (power switch, blackout) and comes back later, the unit will automatically initialize the MS system again, finding and integrating all active slaves. In this case, MS can be restored automatically.
- If accidentally multiple or no units are defined as master the master-slave system cannot be initialized

In situations where one or multiple units generate a unit alarm like OVP etc. following applies:

- Any alarm of a slave is indicated on the slave’s display and on the master’s display.
- If multiple alarms happen simultaneously, the master only indicates the most recent one. In this case, the particular alarms can be read from the slave units displays or via digital interface during remote control or remote supervision.
- All units in the MS system supervise their own values regarding overvoltage, overcurrent and overpower and in case of alarm they report the alarm to the master. In situations where the current is probably not balanced between the units, it can occur that one unit generates an OCP alarm though the global OCP limit of the MS system was not reached. The same can occur with the OPP alarm.

Note: When several units of a parallel system are not going to be used and remain switched off, depending on the number of active units and the dynamics of the operation, it may

be necessary to disconnect the inactive units from the Share bus. When not powered, these units can have a negative impact on the Share bus due to their impedance.

8.2 Series Operation



Series connection of two or multiple unit is possible. However, for reasons of safety and isolation, the following restrictions apply:

- Both, negative (DC-) and positive (DC+) output poles are connected to PE via X type capacitors.
- No DC minus pole of any unit in the series connection must have a potential with respect to ground (PE) higher than specified in the technical specifications section! The maximum allowed potential shift varies from model to model and is different for DC plus and DC minus.
- The Share Bus must not be wired and used!
- Remote sensing must not be used!
- Series connection is only allowed with units of the same kind and model, i.e. power supply with power supply, like for example DCS80-170-4 3U with a DCS80-170-4 3U resp. also with DCS80-170 3U or DCS80-170-2 3U.

Series connection in Master-Slave mode is not supported. It means, all units have to controlled separately regarding set values and DC output status, whether it is manual control or remote control (digital or analog).

Due to the max. allowed potential shift on the DC output, certain models can not be connected in series at all, for example, the 1000 V model, because the DC plus there is only isolated up to 1000 V. Conversely, two 500 V models are eligible for series connection.

Analog interfaces on units in a serial connection can be connected in parallel as they are galvanically isolated. It is also allowed to ground the GND pins of the analog interfaces connected in parallel, which may happen automatically, when connecting them to a controlling unit such as a PC, where grounds are directly tied to PE.

8.3 Battery Charging Operation

A DC power supply can be used as a battery charger, but with some restrictions, because it lacks a battery monitoring system and any physical separation from the load in form of a relay or contactor, which are present in real battery chargers as a form of protection.

The following has to be considered for this kind of application:



- No reverse polarity protection provided! Connecting a battery with reversed polarity will damage the power supply severely, even if it is not powered on.
- All DCS Series models have an internal circuit, i.e. base load, for faster discharge of voltage when switching the DC output off or ramping voltage down. This base load would –slowly - discharge the battery while the DC output is switched off, meaning while it is not charging. This would however not occur when the power supply is not powered at all. It is thus recommended to leave the DC output switched on as long as the battery is connected (similar to trickle charging) and only switch if off for the purpose of connecting or disconnecting a battery.

8.4 Two Quadrant Operation (2QO)

This mode of operation refers to the use of a source, in this case a DCS Series power supply, and a sink such as a 6RL Series electronic load. The source and the sink function alternate in order to test a unit, such as a battery, by deliberately charging and discharging it as part of a functional or final test.

The user can decide whether the system is operated manually or the power supply as the dominant unit or both units controlled by a PC. We recommend to focus on the power supply, which is intended to control the load via the Share Bus connection. Two quadrant operation is only possible in constant voltage mode (CV).

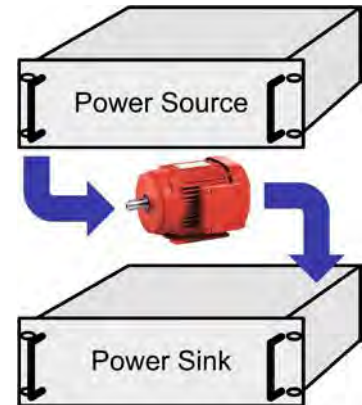

8.4.1 2QO Application:

A combination of source and sink can only map the quadrants I + II. This means that only positive voltages are possible. The positive current is generated by the source or application and the negative current flows into the load.

The maximum approved limits for the application should be set in the power supply. This can be done via the interface. The electronic load should preferably be in CV operating mode. The load will then, using the Share Bus, control the output voltage of the power supply. Typical applications:

- Fuel cells
- Capacitor tests
- Motor driven applications
- Electronic tests where a high dynamic discharge is required.

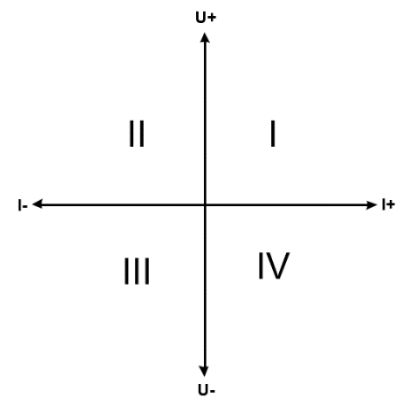

8.4.2 Connecting Units to a 2QO Test Systems

There are several ways to connect a source(s) and a sink(s) to create a 2Quadrant test system:

Configuration A: Load, power supply and one E.U.T.

This is the most common configuration. The nominal values for U, I and P of the two units should match, such as 6RL-170-80 and DCS80-170. The system is controlled by the power supply set to “Master” mode in the setup menu, even if there are no slave DC power supplies.

Configuration B: Multiple loads and supplies, one E.U.T.

The combination of load units and power supply units each create a power block. Here it is also necessary to match the nominal values, especially the voltage of the two systems, i.e. an 80 Vdc input of the loads to a max. 80 Vdc output of the power supplies. The max. number of 16 units cannot be exceeded. Regarding the Share bus connection, all load units must be slaves, while one of the DC Supplies has to be set as a master.

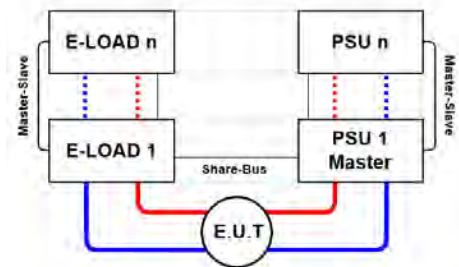
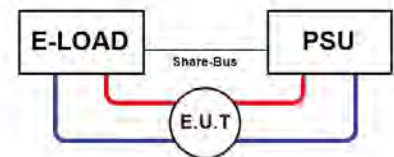

8.4.3 2QO Operation Unit Settings

Regarding 2QO operation where the Share bus connection is sufficient, the load unit(s) are required to set the “Master-slave mode” parameter to SLAVE or OFF (unless part of a M/S system of loads) in. The option “DCS/ 6RL system” must be activated for the master load of a possibly configured M/S system of loads.

On any of the power supplies, preferably PSU 1, master-slave mode must be activated (setting “MASTER”), even if there is only one power supply.

For safety of the connected E.U.T and to prevent damage to it, we recommend to adjust supervision thresholds like OVP, OCP or OPP on all units to the desired levels, which will then switch off the DC output resp. the DC input in case of excessive voltage, current or power.

8.4.4 Restrictions

After all electronic loads have been connected to the Share bus with one power supply as master, they cannot limit their input voltage anymore to what you adjust as “U set” on the unit. The correct voltage level comes from the master unit and has to be adjusted there.

8.4.5 Application example

Charging and discharging a battery with 24 V/400 Ah, using configuration A from above.

- Power supply DCS80-170-4 3U with: $I_{Set} = 40$ A (charging current, 1/10 of capacity), $P_{Set} = 5000$ W.
- Electronic load 6RL-170-80 set to: $I_{Set} = \text{max. discharging current of the battery (e.g. 100 A)}$, $P_{Set} = 3500$ W, plus probably UVD = 20 V with event type “Alarm” to stop discharging at a certain low voltage threshold.
- Assumption: battery has a voltage of 26 V at test start.
- DC input(s) and DC output(s) of all units switched off.

Note: In this configuration, it is recommended to always switch on the power source DC output on **first** and then the DC input of the load.

Stage 1: Discharge of the battery to 24V

Setup: Voltage on the power supply set to 24 V, DC output of power supply and DC input of load activated

Reaction: The e-load will load the battery with a maximum current of 100 A in order to discharge it to 24 V. The power supply delivers no current at this moment, because the battery voltage is still higher than what is set on the power supply. The load will gradually reduce the input current in order to maintain the battery voltage at 24 V. Once the battery voltage has reached 24 V with a discharge current of approx. 0A, the voltage will be maintained at this level by charging from the power supply.

Note: The power supply determines the voltage setting of the load via the Share bus. In order to avoid deep discharge of the battery due to accidentally setting the voltage on the power to a very low value, it is recommended to configure the under voltage detection feature (UVD) of the load, so it will switch off the DC input when reaching minimum allowed discharge voltage. The settings of the load, as given via the Share bus, cannot be read from the load’s display.

Stage 2: Charge the battery to 27V

Setup: Voltage on the power supply set to 27 V

Reaction: The power supply will charge the battery with a maximum current of 40 A, which will gradually reduce with increasing voltage as a reaction to the changing internal resistance of the battery. The load absorbs no current during this charging phase, because it is controlled via the Share bus and set to a voltage still higher than the actual battery voltage and the actual output voltage of the power supply. When the voltage reaches 27 V, the power supply will deliver only the current needed to maintain the battery voltage.

9 Calibration

9.1 Preface

DCS Series units support adjustment of the most important DC output related values, which can help in case these values are out of tolerance. The procedure is limited to compensate small differences of up to 1% or 2% from the specifications. There are several reasons which could make it necessary to readjust a unit: component aging, component deterioration, extreme ambient conditions, high frequent use.

In order to determine if a value is out of tolerance, the parameter must be verified first with measurement tools of sufficiently high accuracy and with at least half the error of the DCS unit specification. Only then can a comparison between values displayed on the DCS unit and true DC output values be made.

For example, if you want to verify and possibly readjust the output current of model DCS80-510-4, which has 510A maximum current, stated with a max. error of 0.2%, you can only do that by using a high current shunt with max. 0.1% error or less. Also, when measuring such high currents, it is recommended to keep the calibration process short, in order to avoid the shunt from over-heating. It is furthermore recommended to use a shunt with at least 25% current margin.

When measuring the current with a shunt, the measurement error of the multi-meter on the shunt adds to the error of the shunt and the sum of both must not exceed the max. error of the unit under calibration.

9.2 Preparation

For a successful calibration and readjustment, a few tools and certain ambient conditions are required:

- A measurement device (multi-meter) for voltage, with a max. error of half the unit's voltage error. That measurement device can also be used to measure the shunt voltage when readjusting the current.
- If the current is also going to be calibrated: a suitable DC current shunt, ideally specified for at least 1.25 times the max. output current of the unit and with a max. error that is half or less than the max. current error of the DCS model to calibrate.
- Normal ambient temperature of approx. 20-25°C.
- Allow the unit to warm up by running for at least 10 minutes under 50% power.
- One or two adjustable loads, preferably electronic ones, which are capable of consuming at least 102% of the max. voltage and current of the unit and which are calibrated and precise.

Before you can start calibrating, a few steps must be taken:

- Let the unit warm up for at least 10 minutes under 50% load.
- In case the remote sensing input is going to be calibrated, prepare a cable for the remote sensing connector to DC output, but leave it yet unconnected.
- Abort any form of remote control, deactivate master-slave mode, set unit to U/I mode.

- Install the shunt between the unit and the load and make sure the shunt has forced air-cooling.
- Connect the external reference measurement unit to the DC output or to the shunt, depending on whether the voltage is going to be calibrated first or the current.

9.3 Calibration Procedure

After the preparation, the unit is ready to be calibrated. From now on, a certain sequence of parameter calibration is important. Generally, you do not need to calibrate all three parameters, but it is recommended to do so.

Note: When calibrating the output voltage, the remote sense input (“Sense”) on the rear of the unit has to be disconnected.

The calibration procedure, as explained below, is an example using model DCS80-170-4. Other models are calibrated the same way, with values according to the particular DCS model and the required load.

9.3.1 Calibrating Set Values

How to calibrate the output voltage

1. Connect a multi-meter to the DC output. Connect a load and set its current to approx. 5% of the nominal current of the power supply, in this example ~8 A, and 0 V (if the load is electronic).
2. In the display, tap MENU, then “**General Settings**”, then go to **Page 7** and then tap **START**.
3. In the next screen select: **Voltage calibration**, then **Calibrate output val.** and **NEXT**. The power supply will switch the DC output on, set a certain output voltage and show the measured value as **U-mon**.
4. The next screen requests you to enter the measured output voltage from the multi-meter at **Measured value=**. Enter it using the key pad, that appears when tapping the value. Assure yourself the value is correct and submit with **ENTER**.
5. Repeat point 4. for the next three steps (total of four steps).

How to calibrate the output current

1. Set the load to approx. 102% nominal current of the DCS model, for the example model with 170A this would be 173.4 A, rounded to 174 A.
 - a. In the display, tap MENU, then “**General Settings**”, then go to **Page 7** and then tap **START**.
2. In the next screen select: **Current calibration**, then **Calibrate output val.** and **NEXT**. The device will switch on the DC output, set a certain current limit while loaded by the load/sink and show the measured output current as **I-mon**.
3. The next screen requests you to enter the output current **Measured value=** measured with your shunt. Enter it using the keypad and assure yourself the value is correct and submit with **ENTER**.
4. Repeat point 4. for the next three steps (total of four steps).

9.3.2 Calibrating Remote Sense

In the remote sensing feature is used, it is recommended to also calibrate this feature for best results. The procedure is identical to the calibration of voltage, except it requires the sensing

connector (Sense) on the rear to be plugged in and connected with correct polarity to the DC output of the DCS.

How to calibrate the output voltage for remote sensing

1. Connect a load and set its current to approx. 5% of the nominal current of the power supply, in this example ~8 A, and 0 V (if the load is electronic). Connect a DMM to the DC terminal of the load and connect the remote sensing input (Sense) to the DC terminal of the load with correct polarity.
2. In the display of the unit, tap MENU, then “**General Settings**”, then go to **Page 7** and then tap **START**.
3. In the next screen select: **Sense volt. calibration.**, then **Calibrate output val.** and **NEXT**.
4. The next screen requests you to enter the measured sensing voltage **Measured value=** from your multi-meter. Enter it using the key pad, that appears when tapping the value. Assure yourself the value is correct and submit with **ENTER**.
5. Repeat point 4. for the next three steps (total of four steps).

9.3.3 Calibrating Measurement Values

The actual value display of output voltage (with and without remote sensing) and output current are calibrated the same way as the set values, but you do not need to enter anything, just confirm the displayed values. Please proceed the above steps and instead of “**Calibrate output value**” select “**Calibrate actual val.**” in the submenus. After the unit shows measured values on display, wait at least 2 seconds for the measured value to settle and then tap NEXT until you complete all steps.

9.3.4 Save Cal Coefficients and Exit

After calibration, you may furthermore enter the current date as “calibration date” by



tapping **Calibration data** in the selection screen and enter the date in format YYYY / MM / DD.



Last but not least save the calibration data permanently by tapping **Save and exit**.

Note: Leaving the calibration selection menu without tapping “Save and exit” will discard new calibration data and the procedure will have to be repeated!

10 CE MARK Declaration of Conformity

Product Name: DCS Series, DC Power Supplies, All Models in Series
Manufacturer: Adaptive Power Systems, Inc.
 17711 Mitchell North
 Irvine, California, 92614, USA

This declaration of conformity is issued under the sole responsibility of the manufacturer. It serves to declare that this Model Series complies with all requirements for CE marking.

The object of the declaration described above is in conformity with here relevant Community harmonization legislation:

EU Directives:	2014/30/EC	EMC Directive
	2014/35/EC	Low Voltage Directive
	2011/65/EC	RoHS2 directive

The manufacturer hereby declares that the products are in conformity with the following standards or other normative documents:

RoHS (DIRECTIVE 2011/65/EU)

Standard applied EN 50581:2012 (Exempt as WEEE Category 9 until 22 July 2017)

SAFETY (DIRECTIVE 2014/35/EC):

Standard applied EN 61010-1: 2010 (3rd Edition)

EMC (DIRECTIVE 2014/30/EU):

Standard applied EN 61326-1: 2013

Reference Standards:

EMISSIONS:	Harmonics	EN 55011:2009+A1:2010	Conducted Emissions
	Flicker	EN 61000-3-2: 2006+A1:2009+A2:2009	
		EN 61000-3-3: 2013	
		IEC 61000-6-2: 2016	Radiated Emissions
		IEC 61000-6-3: 2006, Class B	
IMMUNITY:		EN 61000-4-2:2009	Electrostatic Discharge
		EN 61000-4-3:2006+A1:2008+A2:2010	Radio Frequency
		EN 61000-4-4:2004+A1:2010	Fast Transient Burst
		EN 61000-4-5:2006	Power Line Surge Immunity
		EN 61000-4-6:2009	RF Common Mode
		EN 61000-4-8:2010	Power Freq. Magnetic Field
		IEC 61000-4-11:2004	Voltage Dips & Short, Interruptions

Supplemental Information:

Signed for and on behalf of: Adaptive Power Systems, Inc.
 October 4, 2018, Irvine, California, USA

Authorized Signatory: Quality Manager



Mark of Compliance

Index

A		Fuse	66
AC Input	67	I	
Accessories	23	Installation	11, 58
C		P	
Constant Resistance	18, 20	Programming	76, 133
Constant Voltage	18	S	
Contact	9, 75	Specifications	28
Contents	3	W	
F		Warranty	10
Features	17		





ADAPTIVE Power Systems

Worldwide Supplier of Power Equipment

Copyright © 2024, Adaptive Power Systems, Inc. (APS) • All Rights Reserved • No reproduction without written authorization from APS.