

Introducing the RGS Series

The Industry's Most Flexible,
 High Performing, and Intelligent
 Regenerative Grid Simulator

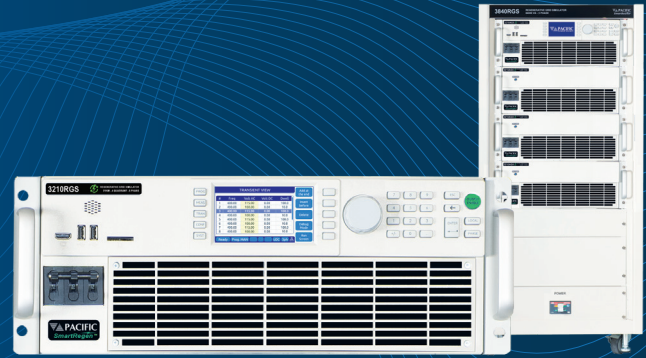

Regenerative

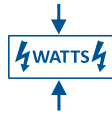

Power
 Density

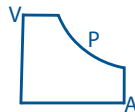

Constant
 Power



High
 Current



Grid
 Compliance
 Test

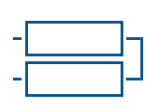

Scalable
 Power

Key Features

- Regenerative Grid Simulator
 - » 4-Quadrant AC & DC Power Source
 - » AC/DC Electronic Load Option
- High Power Density – Up to 21kW in 4U; Parallel up to 168kVA/kW per Cabinet, or Multiple Cabinets up to 252kW
- AC, and DC Output Capability, optional AC+DC mode
- Single, Split, Three-Phase; Multi-Channel Mode
 - » Isolated Neutrals Available (Option W)
- Constant Power Voltage Range:
 350Vac L-N/606Vac L-L or ± 500 Vdc
- High Frequency Range 15Hz - 200Hz
- Galvanic Isolation from Facility AC Input to Output and Between Output Phases / Channels
- Dynamic, Quiet and Efficient Operation Using Silicon Carbide (SiC) Based Technology
- High AC Current Range
- Waveform Capture and Scope Display
- Powerful Line Disturbance Tools
 - » Generate Harmonics and Interharmonics
 - » Analog I/O Signals Standard
- Intuitive User Interface Using Softkeys & Shuttle
- **SmartSource Suite:** Web Browser Control
- IEC61000-4-13 Inter-Harmonics Test

RGS Series

Regenerative Grid Simulator

The RGS Regenerative Grid Simulator is designed to emulate real-world grid connections for testing EV, Solar PV inverters and smart-grid applications. The RGS's high-power density provides 12kVA/kW up to 21kVA/kW in a 4U chassis and can parallel up to 168kVA/kW in a single 19" cabinet. Dual cabinets can parallel up to 252kVA/kW.

The RGS Series is modular by design and scalable in power. Its flexible channel outputs and advanced control and programming capabilities make it ideal for generating complex user-defined waveforms.

Full operator control of power, frequency and phase angle settings allows for testing a wide range of grid-tied products. Easily test your UUT to regulatory compliance standards such as IEEE 1547, UL 1741, IEC 61000-3, IEC 61000-4, and more.

Application Examples:

- EV Charging, On Board Chargers (OBC), Wallboxes, V2G, V2H, V2X, and EV Charging Cables
- Solar PV/Grid-Tied Inverters
- Energy Storage Systems (ESS), Home ESS
- Smart-Grid Simulation
- UPS Products and PDUs
- IEC Compliance Testing



Flexible Control

Constant Power Voltage Range

The RGS Series uses a single, constant power voltage range for both higher current at lower voltage and high-voltages at lower currents eliminating the need to switch between voltage ranges.

Typical dual range systems cause temporary output power loss when switching between ranges interrupting power to the unit under test. The RGS's constant power voltage range allows for testing a broad range of conditions and test requirements without interruption of output power.

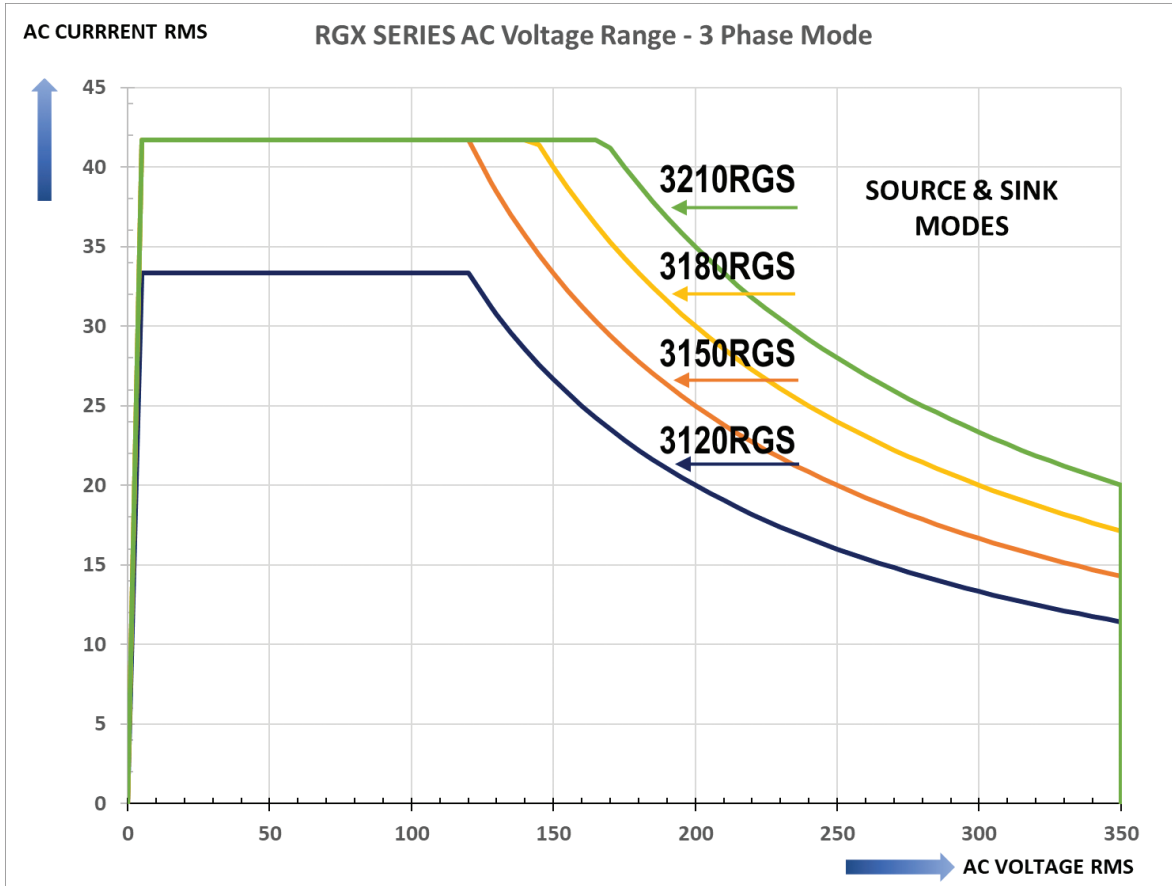

More Current at Low Voltage

The RGS provides a broader range of current eliminating the risk of over or under sizing the power source. This reduces the need for additional capital investment. The diagram to the right illustrates the RGS's capability to provide 20% more current from 120V to 200V when compared to a typical unit that maxes out at 35A/phase.

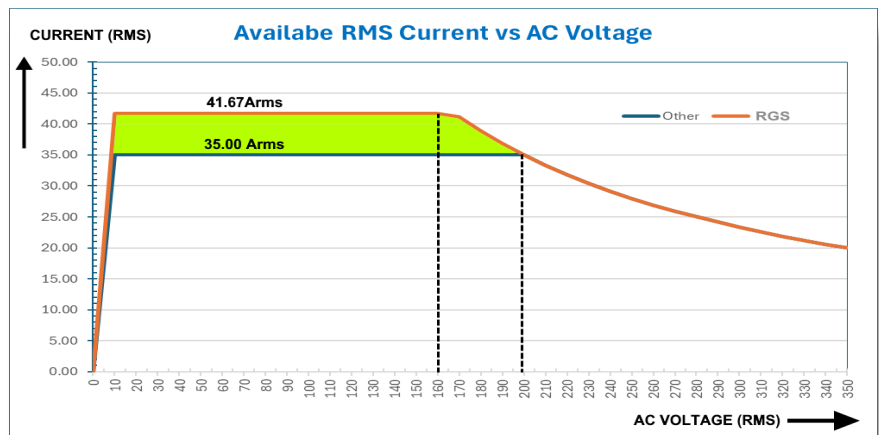

Ultimate Flexibility With Six Output Configurations

Simultaneous AC & DC Operation on Individual Phases

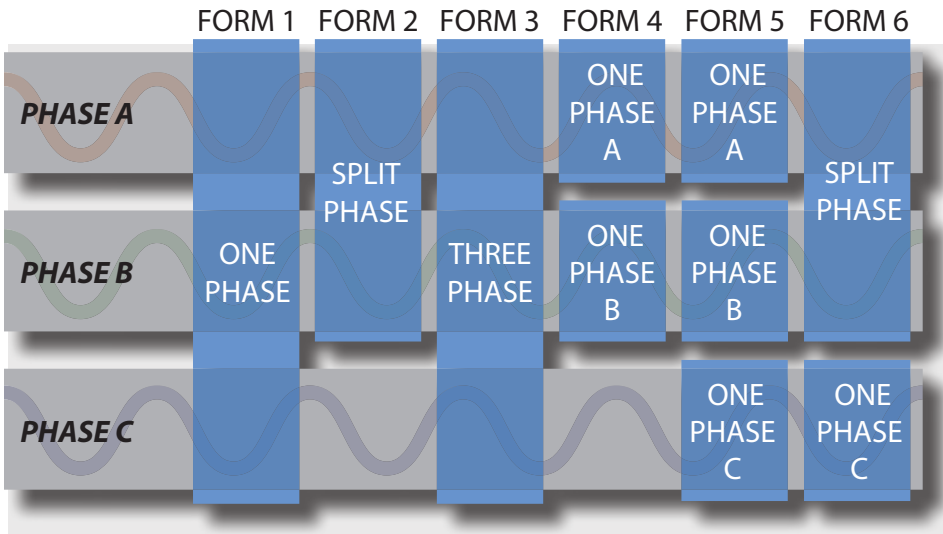

Automatic Switching of Operation Modes

Flexibly test a wide range of grid-tied conditions and EUTs selecting from six different output configurations in either source or load mode. Unique output configuration modes allow different functions per phase: AC Source, DC Supply or Electronic Load (option).

Forms 1 through 3 are typical for three-phase AC sources or loads and single, split or three-phase AC connections.

Regenerative Power Saves Significant Energy and Costs

Regenerative AC & DC power sources provide energy efficiency and significant cost savings by returning energy back to the facility or the grid. The RGS produces less heat, ensures a stable testing environment for reliability reducing the need for additional cooling systems. Regenerative bidirectional power flows are critical for simulating real-world conditions in transportation and renewable energy systems.



Powerful Waveform & Measurement Tools

The RGS has a built-in waveform digitizer and fast transient capabilities at 200µsec time resolution, supporting LIST, PULSE and STEP modes. Waveform generation includes ten Standard, Sine, Square, Triangle, Clipped, Harmonics and Inter-harmonics.

The waveform digitizer is complemented by a digital measurement system with scope function. Capture advanced measurements and waveforms.

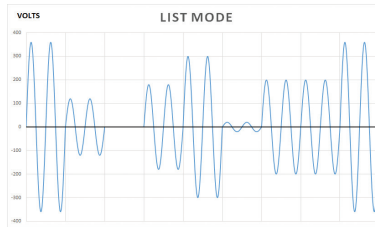

List Mode

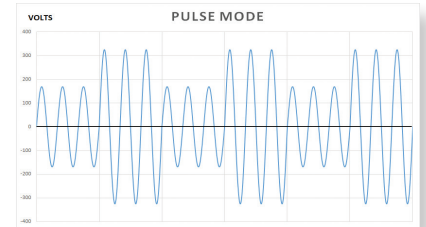

Pulse Mode

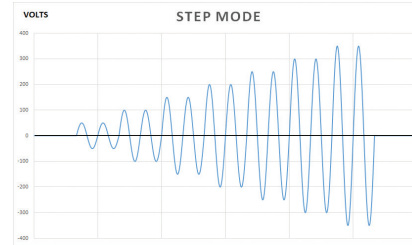

Step Mode

Fully Test AC Power with 4-Quadrant Load (Option L)

Optional load feature also supports testing PV inverters, V2G, EV Chargers, EVSE, batteries, UPS, and AC/DC power supplies. A key advantage of the RGS Regenerative Load Option is its ability to operate in all four quadrants using programmable phase shift in CC or CS modes.

Compared to 2-Quadrant non-regenerative AC loads, the RGS allows simulation of inductive and capacitive loads to fully test AC power sources, as shown in the leading and lagging power factor examples.

The "L" Option adds Regenerative Electronic Load capability providing several AC and DC operating modes to push the boundaries of test environment. Simulate linear and non-linear loads (rectified), inductive and capacitive loads.

AC Modes: Constant Current, Constant Power & Apparent Power, Constant Resistance, Constant Voltage, CC+CR, CC / CS Rectifier Mode 1 ϕ & 3 ϕ

DC Modes: Constant Current, Constant Power, Constant Resistance, Constant Voltage, CR+CC

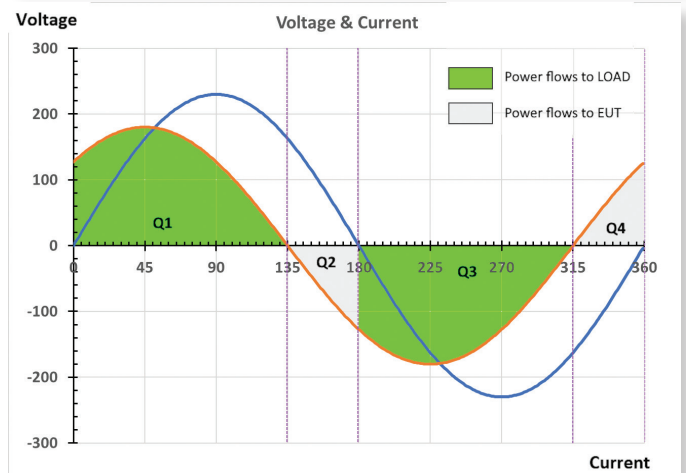
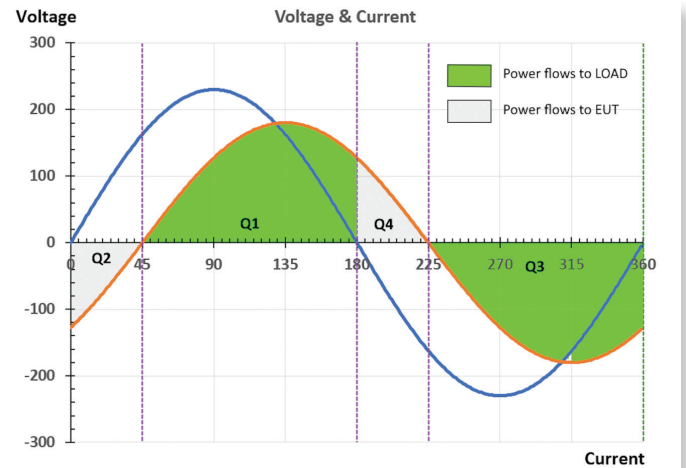

User Friendly Control Options

Multiple integrated control options include:

- Intuitive Touch Screen LCD Display with Soft Key driven Menus
- SmartSource Suite Web Interface
- LAN, GPIB, RS232 & USB Interfaces, and ModBus (optional)
- Supports external touch screen monitor via Video Output Interface

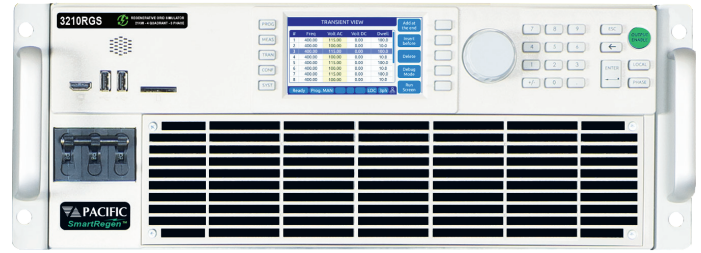

Simplify Test Automation with SmartSource Suite Remote Control Platform

Easily monitor, control, and manage testing with the RGS's SmartSource Suite remote control platform. Use the embedded, web browser interface with real-time control. Access control panels and test sequences on-premises or on any mobile device (laptop, phone, tablet) via secure client access.

- Full control and measurement capability
- Program settings and measurement read back including digital scope and harmonics data
- Extensive safety protection settings
- Waveform selection, preview and edit modes
- Execution of user's custom test sequences
- Transient data entry and execution screen using a spreadsheet layout

Built-in Galvanic Isolation Reduces Safety Risks

The RGS provides both facility-to-output isolation, and phase to phase or channel to channel isolation. Galvanic isolation provides complete separation between the input and output so there is no electron flow between channels. Channel to channel isolation provides flexibility to use each phase as its own independent power source with full frequency and voltage control. The RGS's fully isolated design reduces safety risks for the operator and prevents unexpected UUT damage by preventing unwanted current or ground loops. This built-in capability doesn't require a transformer which saves significant costs and space.

Modular Power up to 168kW/333A per Cabinet

The RGS Series provides modular and scalable power to meet changing test requirements. Easily parallel multiple chassis to reach up to 168kW with 333Amps per cabinet. Cabinets can be paralleled up to 252kW. The ease of re-configuration allows for flexible test set ups and reduces downtime for repairs or maintenance. The units' shallower depth also allows it to fit into typical 31.5-inch / 800.1mm depth cabinets with ample room for air-flow and wiring.

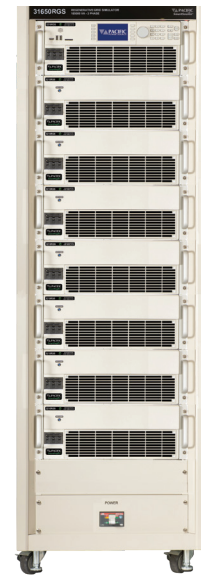

RGS Dimensions & Accessories

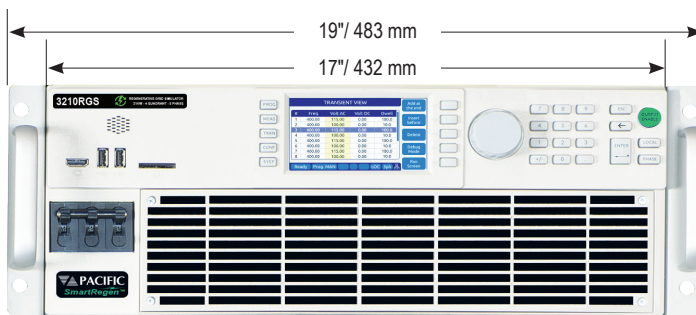

The RGS is designed for bench top or 19" equipment rack operation. Product is shown with included rack mount handles.

Depth of chassis is only 25.0 inch / 635mm.

Note: Units can be zero-stacked in 19" EIA cabinet when using optional rack-slides. When using L-brackets, allow 1U space between units.

The RGS Rear Panel provides connections for AC Input, AC or DC Output, External Sense, Aux I/O and remote control interfaces. Product is shown with standard GPIB Interface.

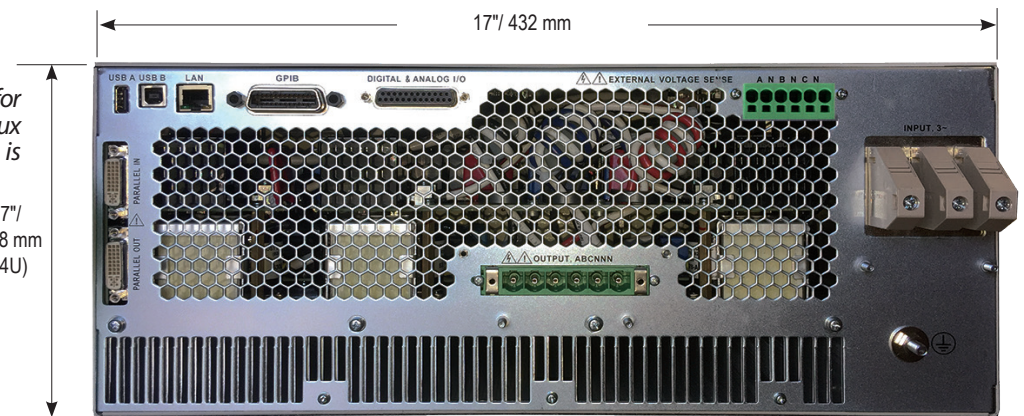

Safety Cover & Strain Relief Kit Option

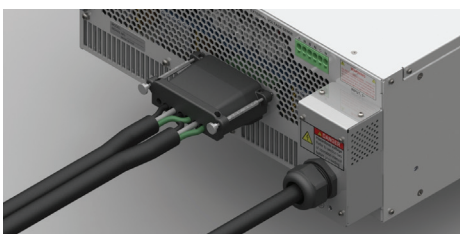

This optional kit includes covers for AC input and AC & DC Output connections. Both covers include wire strain relief to prevent accidental release of input or output wiring.

Note: AC input and AC output wiring is NOT included.

Technical Specifications

MODEL:	3120RGS-4	3150RGS-4	3180RGS-4	3210RGS-4
Modes of Operation				
Regenerative Grid Simulator, Regenerative DC Power Source. Regenerative Electronic Load optional.				
AC or DC Output				
Phase Modes (Form)	1, 2 or 3	1, 2 or 3	1, 2 or 3	1, 2 or 3
Maximum Power (Total)	12 kW/kVA	15 kW/kVA	18 kW/kVA ¹	21 kW/kVA ¹
Per Phase / Channel	4 kW/kVA	5 kW/kVA	6 kW/kVA	7 kW/kVA
Voltage				
Range ²	AC Range: 0 - 350 V _{LN} / 0 - 606 V _{LL} DC Range: 0 - ±500 V _{DC}			
Resolution	0.01		Accuracy:	± 0.25% F.S
Harmonic Distortion R Load	< 100 Hz < 0.3% 100 Hz to 500Hz < 0.5% 500 to 1000 Hz < 1.0% > 1000 Hz < 1.5%			
Line Regulation	< 0.1% for 10% Line Change			
Load Regulation	± 0.02% (CSC Mode)			
Phase Angle - Range (B, C)	0 - 359.9°		Resolution:	0.1°
Maximum Current				
3 & 2 Phase modes AC / DC	34.0 ARMS / 16.7 ADC	42.0 ARMS / 21.0 ADC	42.0 ARMS / 21.0 ADC	42.0 ARMS / 21.0 ADC
1 Phase mode AC / DC	100.0 ARMS / 50.0 ADC	126.0 ARMS / 63.0ADC	126.0 ARMS / 63.0ADC	126.0 ARMS / 63.0ADC
Current Crest Factor (AC)	3.0 : 1	2.5 : 1	2.5 : 1	2.5 : 1
Frequency				
Range	15.00 – 200.0 Hz std or 15.00 - 1200Hz Option F		Resolution / Accuracy:	0.01 Hz / ± 0.01%
AC Input				
Input Voltage Range / Freq	380Vac – 480Vac ± 10%, 4 Wire, L1, L2, L3 and PE / 47 - 63 Hz			
Nom. Phase Current @ 400Vac / 480Vac	21 Arms / 18 Arms	26 Arms / 22 Arms	31 Arms / 26 Arms	36 Arms / 30 Arms
Input Power Factor	0.99		Efficiency:	0.85
Measurement				
Vrms Range / Accuracy	0 – 350 V _{LN} / 0-606 V _{LL} / ± 0.25% F.S.			
Irms Range ³ / Accuracy	34.0 A / ± 0.5% F.S.	42.0 A / ± 0.5% F.S.	42.0 A / ± 0.5% F.S.	42.0 A / ± 0.5% F.S.
Power Range ³ / Accuracy	4 kW / ± 1.5% F.S.	5 kW / ± 1.5% F.S.	6 kW / ± 1.5% F.S.	7 kW / ± 1.5% F.S.
Scope Function	Sample Rate: 54932.47 Hz / Window: 1024 Samples / Bandwidth: 1200 Hz			
Transient Functions				
Programming	200 Steps / 400 Segments, LIST, PULSE & STEP Modes, Frequency, Volt AC, Volt DC, Waveform, Ramp Time, Dwell Time. Time range: 0.1 - 10000000.0 ms, Time resolution 0.2 ms			
Execution	Run from step # to step #, Run, Step, Restart, Stop	Program Storage:	Non-volatile, 100 Programs + Transients	
PARAMETERS / FUNCTIONS SPECIFICATIONS				
Remote Control Interfaces				
USB Type B, LAN (LXI), GPIB / IEEE488, RS232, all on rear panel				
External USB WIFI adapter / ModBus TCP / CAN/CAN-FD				
Analog & Digital I/O				
Analog Inputs (4) / Outputs (4)	Analog Inputs: Voltage phs A,B,C & Frequency		Analog Outputs: Vmeas A, B, C, Pmeas all Phases	
Digital Inputs (6) / Outputs(6)	Remote Inhibit, Trans. Trig., Phase Sync, User		Output Relay, Transient, Function Strobe, Sync	
Environmental				
Cooling	Variable speed fan, front intake, rear exhaust		Energy Saving Modes:	Standby & Sleep
Temperature	Operating:	0 to 40 °C / 32 to 104 °F	Storage:	-20 to 70 °C/-4 to 158 °F
Humidity	< 80%, non-condensing		Altitude:	2000 m / 6500 feet
System Features				
USB Ports	2 on Front Panel, 1 on Rear Panel, All Type A		SD Card:	32 GB max. Capacity
Video Output Port	Monitor Out, Front Panel			
Dimensions & Weights				
Chassis Size H x W x D	7.0" x 17.0" x 25.0" / 178 x 432 x 635 mm		Shipping: 20" x 27" x 38" / 508 x 686 x 965 mm	
Weight Single 4U Height Unit	Net:	111.2 lbs. / 50.4 kg	Shipping:	151 lbs / 68.5 kg
Regulatory Compliance				
Safety	IEC 61010-1:2010 (Edition 3)			
EMC - Emissions / Immunity	EN 55011:2009+A1:2010 / EN 61000-4-2, -4-3, -4-4, -4-5, -4-6, -4-8 and EN 61000-4 -11			
Product Category	EN 61326-1:2013 (Measurement, Laboratory and Control Equipment)			
Agency Approvals	CE Mark, NRTL Nemko US/Canada		RoHS (2011/65/EU):	EN50581:2012

Note 1: Maximum Power rating is reduced below 40Hz on 3180RGS and 3210RGS models

Note 2: Extended Voltage Range: 0 - 365 V_{LN} / 0 - 632 V_{LL}, with V_{THD} < 1.0% @ 50~60Hz

Note 3: Measurement range is times three in single phase mode.

Ordering Information

RGS Series Model Number Encoder:

Note: Solid outlined fields must be specified. Dashed outlined fields are optional.

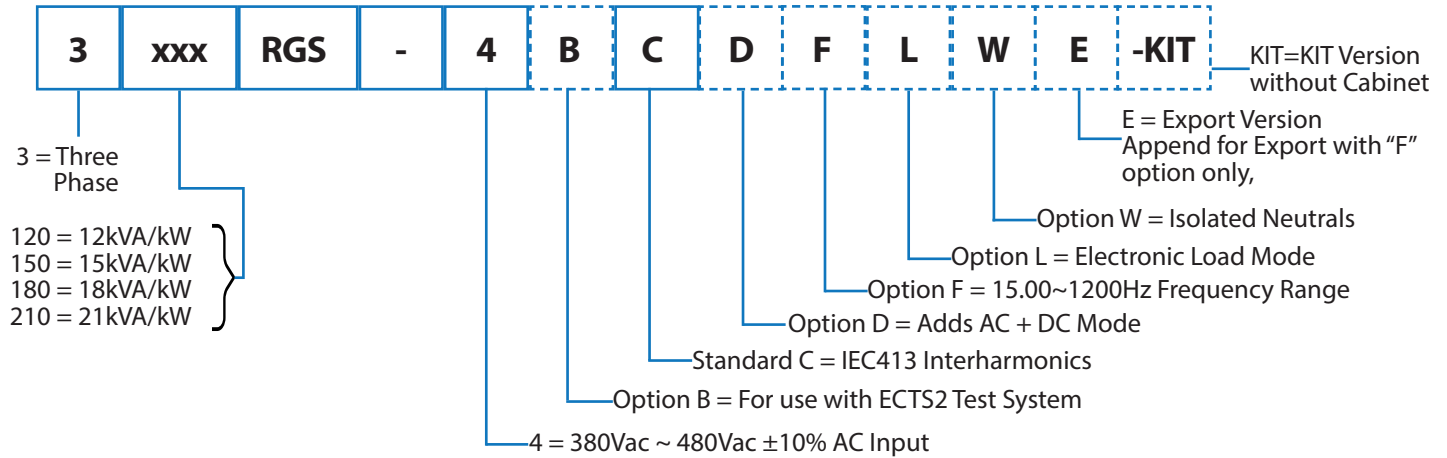

Order Example

3210RGS-4CL

- Bench Model, 21 kVA, 3-Phase, Regenerative Grid Simulator with Load option, USB, RS232, LAN, GPIB & AUX I/O

Typical Delivery Items

- Power Source
- Rack Mount Handles
- Certificate of Compliance

Available Accessories

- Output shorting adapter for single phase output mode use. P/N 160086 (not for W)
- Paralleling Cable, 1 Ft. (Included with Aux NC models). P/N 778036
- Rack slides. P/N 703251

Software Options

Test Sequences

- IEC Test Suite - Includes IEC 61000-4-11p, IEC 61000-4-14, IEC 61000-4-17, IEC 61000-4-27p, IEC 61000-4-28, IEC 61000-4-29p and IEC 61000-4-34
- IEC 61000-4-13 Standard
- IEEE 1547.1-2020
- Semi-F47-0706
- KS C 9610-4-11, KS C 9610-4-29

Test Sequence Options require use of the standard SmartSource Suite via LAN or USB, or PPSC Test Manager Windows Software. Contact factory for details.

Service & Support

NORTH AMERICA

Pacific Power Source, Inc.
Irvine, USA

Phone: +1(949) 251-1800

Fax: +1 (949) 756-0756

Email: info@pacificpower.com

Web: www.pacificpower.com

EUROPE

Pacific Power Source
Europe GmbH.
Kappelrodeck, Germany

Phone: +49 7842 99722-20

Fax: +49 7842 99722-29

Email: info@pacificpower.eu

Web: www.pacificpower.eu

CHINA

PPST Shanghai Co. Ltd.
Shanghai, China

Phone: +86-21-6763-9223

Fax: +86-21-5763-8240

Email: info@ppst.com.cn

Web: www.ppst.com.cn

2802 Kelvin Avenue, Suite 100
Irvine, CA 92614 -5897 USA
Phone: +1 949.251.1800
Toll Free: 800.854.2433
E-mail: sales@pacificpower.com
Web: www.pacificpower.com